

Contents

EN

4	Instructions	4
1.1	General safety instructions	4
1.2	Identification plate	9
1.3	Manufacturer's liability	9
1.4	Appliance purpose	9
1.5	This user manual	10
1.6	To save energy	10
1.7	How to read the user manual	10
2	Description	11
2.1	Cooking hob	12
2.2	Control panel	13
2.3	Other parts	14
2.4	Available accessories	14
3	Use	16
3.1	First use	17
3.2	Using the accessories	17
3.3	Using the gas hob	18
3.4	Using the induction hot plates	19
3.5	Using the ovens	25
3.6	Cooking with the Direct Steam function (humidified oven)	27
3.7	Using the temperature probe (pyrolytic oven)	29
3.8	Use of the storage compartments	32
3.9	Cooking advice	32
3.10	Programmer clock	33
4	Cleaning and maintenance	40
4.1	Cleaning the appliance	40
4.2	Removing the doors	42
4.3	Cleaning the door glazing	42
4.4	Cleaning the inside of the ovens	43
4.5	Pyrolytic cycle (pyrolytic oven)	46
4.6	Extraordinary maintenance	48
5	Installation	50
5.1	Minimum clearance to combustible surfaces	50
5.2	Gas connection	50
5.3	Adaptation to different types of gas	52
5.4	Positioning	54
5.5	Electrical connection	57
5.6	Instructions for the installer	59

We advise you to read this manual carefully, which contains all the instructions for maintaining the appliance's aesthetic and functional qualities. For further information on the product: www.smeg.com



Instructions

1 Instructions

1.1 General safety instructions

Risk of personal injury

- During use the appliance becomes hot. Care should be taken to avoid touching heating elements inside the ovens.
- Protect your hands by wearing oven gloves when moving food inside the oven.
- Never try to put out a fire or flames with water: Turn off the appliance and smother the flames with a fire blanket or other appropriate cover.
- This appliance is not intended for use by persons (including children) with reduced physical, sensory or mental capabilities, or lack of experience and knowledge, unless they have been given supervised or instruction concerning use of the appliance by a responsible person for their safety.
- Young children should be supervised to ensure that they do not play with the appliance.
- Keep children under the age of eight at a safe distance unless they are constantly supervised.
- Keep children under the age of 8 away from the appliance when it is in use.
- Cleaning and maintenance must not be carried out by unsupervised children.
- Make sure that the flame-spreader crowns are correctly positioned in their housings with their respective burner caps.
- Be aware of how rapidly the cooking zones heat up. Do not place empty pans on the heat. Danger of overheating.
- Fats and oils can catch fire if they overheat. Do not leave the appliance unattended while preparing foods containing oils or fats. If fats or oils catch fire, never put water on them. Place the lid on the pan and turn off the relevant cooking zone.
- The cooking process must always be monitored. A short cooking process must be continuously monitored.
- Do not place metal objects, such as dishes or cutlery, on the hob surface during use as they may overheat.
- Do not insert pointed metal objects (cutlery or utensils) into the slots in the appliance.
- Do not pour water directly onto very hot trays.



- Keep the oven door closed during cooking.
- If you need to move food or at the end of cooking, open the door 5 cm for a few seconds, let the steam come out, then open it fully.
- Do not open the storage compartment (where present) when the oven is on and still hot.
- The items inside the storage compartment could be very hot after using the oven.
- **DO NOT USE OR STORE FLAMMABLE MATERIALS IN THE STORAGE COMPARTMENT (IF PRESENT) OR NEAR THE APPLIANCE.**
- **DO NOT SPRAY AEROSOLS IN THE VICINITY OF THIS APPLIANCE WHILE IT IS IN OPERATION.**
- Switch off the appliance immediately after use.
- **DO NOT MODIFY THIS APPLIANCE.**
- Always use any necessary/required personal protective equipment (PPE) before performing any work on the appliance (installation, maintenance, positioning or movement).
- Before performing any work on the appliance, switch off the power supply.
- Installation and servicing should be carried out by qualified personnel in accordance with current standards.
- Do not try to repair the appliance yourself or without the assistance of a qualified technician.
- Do not pull the cable to unplug the appliance.
- If the power supply cable is damaged, contact technical support immediately and they will replace it.
- Do not place articles on or against this appliance.
- Metallic objects such as knives, forks, spoons and lids should not be placed on the hotplate since they can get hot.

Risk of damaging the appliance

- This appliance must not be installed behind a decorative door.
- Do not use abrasive or corrosive detergents (e.g. scouring powders, stain removers and metallic sponges) on glass parts.
- Use wooden or plastic utensils.
- Racks and trays should be inserted as far as they will go into the side guides. The mechanical safety locks that prevent them from being



Instructions

- removed must face downwards and towards the back of the oven cavity.
- Do not sit on the appliance.
 - Do not use steam jets to clean the appliance.
 - Do not obstruct ventilation openings and heat dispersal slots.
 - Never leave the appliance unattended during cooking operations where fats or oils could be released, as these could then heat up and catch fire. Be very careful.
 - NOT SUITABLE WITH AFTERMARKET LIDS OR COVERS.
 - Never leave objects on the cooking surface.
 - DO NOT USE THIS APPLIANCE AS A SPACE HEATER.
 - Do not spray any spray products near the oven.
 - Do not use plastic cookware or containers when cooking food.
 - Do not put sealed tins or containers in the oven.
 - Remove all trays and racks which are not required during cooking.
 - Do not cover the bottom of the oven cavity with aluminium or tin foil sheets.
 - Do not place pans or trays directly on the bottom of the oven cavity.
 - If you wish to use greaseproof paper, place it so that it will not interfere with the hot air circulation inside the oven.
 - Do not use the open door to rest pans or trays on the internal glass pane.
 - Cooking vessels or griddle plates should be placed inside the perimeter of the hob.
 - All pans must have smooth, flat bottoms.
 - If any liquid does boil over or spill, remove the excess from the hob.
 - Take care not to spill acid substances such as lemon juice or vinegar on the hob.
 - Do not put empty pans or frying pans on switched on cooking zones.
 - Do not use steam jets to clean the appliance.
 - Do not use rough or abrasive materials or sharp metal scrapers.
 - Do not use cleaning products containing chlorine, ammonia or bleach on parts made of steel or that have metallic surface finishes (e.g. anodizing, nickel- or chromium-plating).
 - Do not use abrasive or corrosive detergents (e.g. scouring powders, stain removers and metallic sponges) on glass parts.



- Do not wash removable parts such as the hob pan support grids, flame-spreader crowns and burner caps in the dishwasher.
- Never use the oven door to lever the appliance into place when fitting.
- Avoid exerting too much pressure on the oven door when open.
- Do not use the handle to lift or move the appliance.

Installation

- **THIS APPLIANCE MUST NOT BE INSTALLED IN BOATS OR CARAVANS.**
- The appliance must not be installed on a pedestal.
- Position the appliance into the cabinet cut-out with the help of a second person.
- To avoid potential overheating, the appliance must not be installed behind a decorative door or a panel.
- Have the gas connection performed by authorised technical personnel.
- Installation using a hose must be carried out so that the length of the hose does not exceed 2 metres when fully extended for steel hoses and 1.5 metres for rubber hoses.
- The hoses should not come into contact with moving parts and should not be crushed in any way.
- If required, use a pressure regulator that complies with current regulations.
- After carrying out any operation, check that the tightening torque of gas connections is between 10 Nm and 15 Nm.
- At the end of the installation, check for any leaks with a soapy solution, never with a flame.
- Have the electrical connection performed by authorised technical personnel.
- The appliance must be connected to earth in compliance with electrical system safety standards.
- Use cables withstanding a temperature of at least 90°C.
- The tightening torque of the screws of the terminal supply wires must be 1.5 - 2 Nm.
- Before installation, make sure that the local gas supply (gas type and pressure) and the settings of the domestic appliance are compatible.
- The settings for this domestic appliance are shown on the gas setting label.
- This domestic appliance is not connected to a device for extracting combustion products. It



Instructions

must be installed and connected in accordance with current installation regulations. Pay particular attention to the relevant requirements regarding ventilation.

For this appliance

- Ensure that the appliance is switched off before replacing the bulb.
- Do not rest any weight or sit on the open door of the appliance.
- Take care that no objects are stuck in the doors.
- The appliance is not intended for use by persons (including children) with reduced physical, sensory or mental capabilities, or lack of experience and knowledge, unless they have been given supervised or instruction concerning use of the appliance by a responsible person for their safety.
- Young children should be supervised to ensure that they do not play with the appliance.
- During use the appliance becomes hot. Care should be taken to avoid touching heating elements inside the oven.
- **WARNING:** Ensure the appliance is switched off before replacing the lamp to avoid the possibility of electric shock.
- **WARNING - Accessible parts will become hot when in use.** To avoid burns young children should be kept away.
- This appliance is not intended to be operated by means of external timer or separate remote control system.
- Do not use a steam cleaner to clean this appliance.
- Do not use harsh abrasive cleaners or sharp metal scrapers to clean the oven glass door since they can scratch the surface, which may result in shattering of the glass.
- If this appliance is installed on a base, measures must be taken to prevent the appliance from slipping from the base.
- If the electrical supply is restricted, means of all-pole disconnection must be accessible and incorporated in the fixed wiring in accordance with the wiring rules.
- **Danger of fire – Do not store items on the cooking surface.**
- **CAUTION – The cooking process has to be supervised.** A short term cooking process has to be supervised continuously.
- **Warning – Unattended cooking on a hob with fat or oil can be**



dangerous and may result in a fire.

- **WARNING:** If the surface is cracked, switch off the appliance to avoid the possibility of an electric shock.
- **Pyrolytic Models Only:** During the automatic cleaning cycle, the outer door window could become hotter than normal. Excess spillage must be removed before cleaning cycle begins.
- If the range is not fitted with a flexible cord, the instruction manual must clearly state the type and size of cord to be used.
- If this cooking range is to be connected to a new or upgraded electrical installation, then it must be connected by a supply cord fitted with:
 - An appropriate rated plug that is compatible with the socket-outlet fitted to the final sub-circuit in the fixed wiring that supplies this cooker.
 - An appropriate rated installation male connector that is compatible with the installation female connector fitted to the final sub-circuit in the fixed wiring that supplies the cooker.

1.2 Identification plate

The identification plate bears the technical data, serial number and brand name of the appliance. Do not remove the identification plate for any reason. Place the supplied duplicate data plate to a suitable adjacent surface or within the instruction manual for future reference.

1.3 Manufacturer's liability

The manufacturer declines all liability for damage to persons or property caused by:

- Use of the appliance other than that specified
- Failure to comply with the instructions in the user manual
- Tampering with any part of the appliance
- The use of non-original spare parts.

1.4 Appliance purpose

- This appliance is intended for cooking food in the home environment. Every other use is considered improper.
- The appliance is not designed to operate with external timers or with remote-control systems.



Instructions

1.5 This user manual

This user manual is an integral part of the appliance and must therefore be kept in its entirety and within the user's reach for the whole working life of the appliance.

- Read this user manual carefully before using the appliance.

1.6 To save energy

- Only preheat the appliance if the recipe requires you to do so.
- Unless otherwise indicated on the package, defrost frozen foods before placing them in the oven.
- When cooking several types of food it is recommended to cook the foods one after the other to make the best use of the already hot oven.
- Use dark metal moulds: They help to absorb the heat better.
- Remove all trays and racks which are not required during cooking.
- Stop cooking a few minutes before the time normally used. Cooking will continue for the remaining minutes with the heat which has accumulated inside the oven.
- Reduce any opening of the door to a minimum to avoid heat dispersal.
- Keep the inside of the oven clean at all times.

1.7 How to read the user manual

This user manual uses the following reading conventions:

Instructions



General information on this user manual, on safety and final disposal.

Description



Description of the appliance and its accessories.

Use



Information on the use of the appliance and its accessories, cooking advice.

Cleaning and maintenance



Information for proper cleaning and maintenance of the appliance.

Installation



Information for the qualified technician: Installation, operation and inspection.



Safety instructions



Information



Advice

1. Sequence of instructions for use.

- Standalone instruction.



2 Description

General description

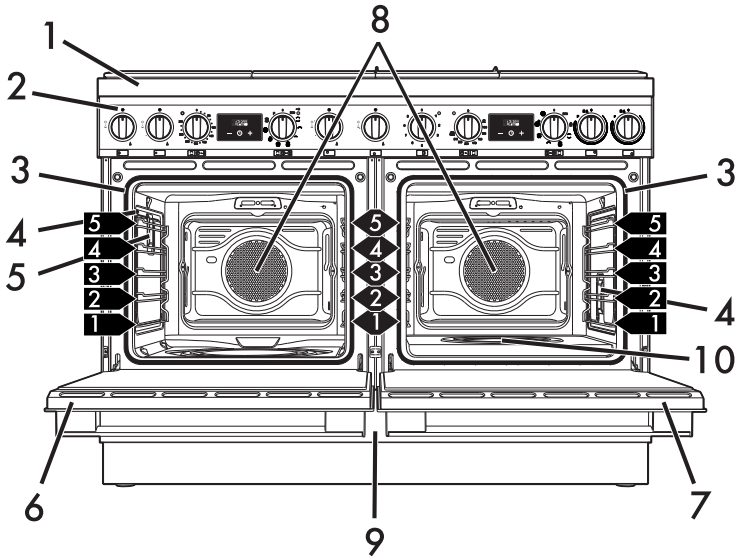

1 Cooking hob

2 Control panel

3 Seals

4 Lamps

5 Temperature probe socket

6 Pyrolytic oven door

7 Humidified oven door

8 Fans

9 Storage compartments

10 Evaporation tray

1,2,3... Rack/tray support frame shelf



Description

2.1 Cooking hob

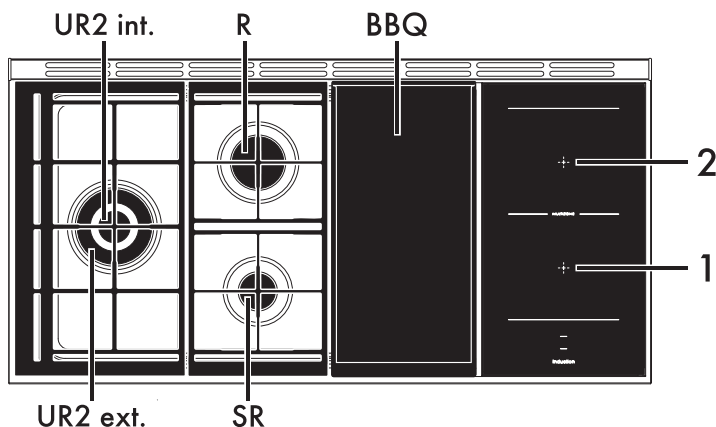

SR = Semi-rapid burner

R = Rapid burner

BBQ = Barbecue plate

1 = Front induction cooking zone

2 = Rear induction cooking zone

UR2 int. = Internal Ultra Rapid burner crown

UR2 ext. = External Ultra Rapid burner

Zone	Dimensions (H x L - mm)	Max. power draw (W)*	Max. power draw in booster function (W)*
1	201 x 197	1650	1850
2	201 x 197	2100	3000

Advantages of induction cooking



The hob is equipped with an induction generator for each cooking zone. Each generator located under the glass ceramic cooking surface creates an electromagnetic field which induces a thermal current in the base of the pan. This means the heat is no longer transmitted from the hob to the pan but created directly inside the pan by the inductive current.





- Energy saving thanks to the direct transmission of energy to the pan (suitable magnetisable cookware is required) compared to traditional electric cooking.
- Improved safety as the energy is only transmitted to the pan placed on the hob.
- High level of energy transmitted from the induction cooking zone to the base of the pan.
- Rapid heating speed.
- Reduced danger of burns as the cooking surface is only heated under the base of the pan; foods which overflow do not stick.

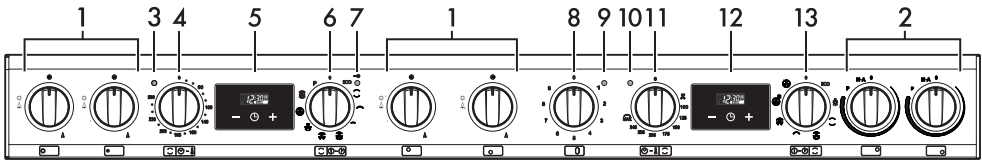

2.2 Control panel



1 Hob burner knobs

For lighting and adjusting the hob burners. Press and turn the knobs anti-clockwise to  in order to light the relative burners. Turn the knobs to the zone between the maximum  and minimum  setting to adjust the flame. Return the knobs to the  position to turn off the burners.

2 Cooking zone control knobs

Useful for controlling the cooking zones of the induction hob. Turn the knobs clockwise to adjust the operating power of the hot plate from a minimum of **1** to a maximum of **9**. The working power is indicated on the display on the hob.

3 - 10 Indicator light

The indicator light comes on to indicate that the oven is heating up. It turns off as soon as it reaches the set temperature. It flashes regularly to indicate that the temperature set inside the oven is kept constant.

4 - 11 Temperature knob

This knob allows you to select the cooking temperature. Turn the knobs clockwise to the required value, between the minimum and maximum setting.

5 - 12 Programmer clock

Useful for displaying the current time, setting programmed cooking operations and programming the minute minder timer.

6 - 13 Function knob

The oven's various functions are suitable for different cooking modes. After selecting the required function, set the cooking temperature using the temperature knob.

7 Door lock indicator light

It comes on when the automatic cleaning cycle (Pyrolytic) is activated.

8 Barbecue knob

Adjusts the power of the barbecue element on the hob.

Turn the knob to any position from **1** to **9** to activate the heating element.



Description

9 Barbecue indicator light

Turns on to indicate that the barbecue heating element is on. It turns off as soon as it reaches the set temperature. It flashes regularly to indicate that the temperature set for the element is kept constant.

2.3 Other parts

Shelves

The appliance features shelves for positioning trays and racks at different heights. The insertion heights are indicated from the bottom upwards (see "General description").

Cooling fan

The fan cools the ovens and comes into operation during cooking.

The fan causes a steady outflow of air that exits from the rear of the appliance and which may continue for a brief period of time even after the appliance has been turned off.

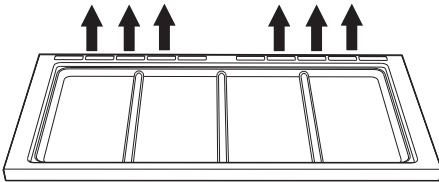

Interior lighting

The appliance interior lighting comes on:

- When the door is opened
- When any function is selected.

2.4 Available accessories

Tray

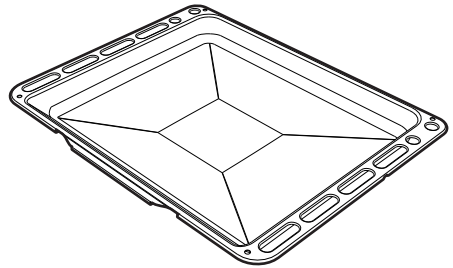
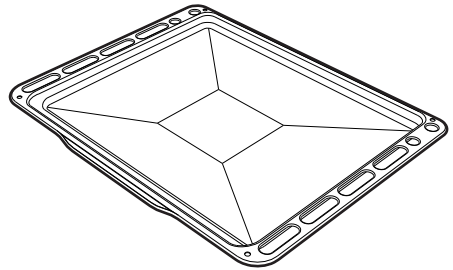

Useful for collecting fat from foods placed on the rack above.

Evaporation tray and cover (humidified oven only)

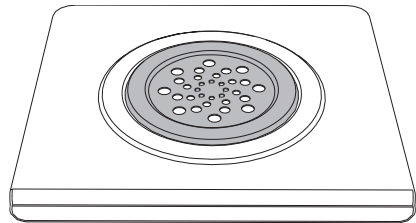

Used to distribute the steam inside the oven.



Tray rack

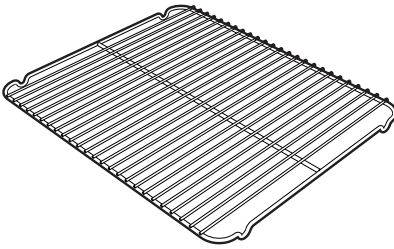

To be placed over the top of the oven tray; for cooking foods which may drip.

Rack

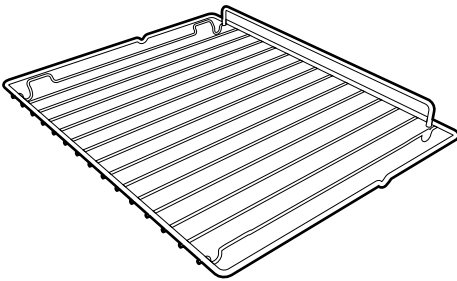

Useful for supporting containers with food during cooking.

Temperature probe (pyrolytic oven only)



With the temperature probe, you can cook according to the temperature measured at the centre the food.

Protective cover (pyrolytic oven only)

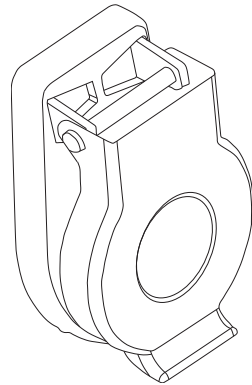

Used to cover and protect the temperature probe socket when the temperature probe is not in use.



The accessories intended to come into contact with food are made of materials that comply with the provisions of current legislation.



Supplied and optional accessories can be requested to Authorised Assistance Centres. Use only original accessories supplied by the manufacturer.



3 Use

Instructions



High temperature inside the oven during use

Danger of burns

- Keep the oven door closed during cooking.
- Protect your hands wearing heat resistant gloves when moving food inside the oven.
- Do not touch the heating elements inside the oven.
- Do not pour water directly onto very hot trays.
- Do not allow children younger than 8 years old to come near the appliance when in operation.
- If you need to move food or at the end of cooking, open the door 5 cm for a few seconds, let the steam come out, then open it fully.



High temperature inside the storage compartment

Danger of burns

- Do not open the storage compartment when the oven is on and still hot.
- The items inside the storage compartment could be very hot after using the oven.



Improper use

Danger of burns

- Make sure that the flame-spreader crowns are correctly positioned in their housings with their respective burner caps.
- Oils and fat could catch fire if overheated. Be very careful.



High temperature inside the oven during use

Danger of fire or explosion

- Do not spray any spray products near the oven.
- Do not use or leave flammable materials near the oven or the storage compartment.
- Do not use plastic kitchenware or containers when cooking food.
- Do not put sealed tins or containers in the oven.
- Do not leave the oven unattended during cooking operations where fats or oils could be released.
- Remove all trays and racks which are not required during cooking.



Improper use

Risk of damage to surfaces

- Do not cover the bottom of the oven cavity with aluminium or tin foil sheets.
- If you wish to use greaseproof paper, place it so that it will not interfere with the hot air circulation inside the oven.
- Do not place pans or trays directly on the bottom of the oven cavity.
- Do not use the open door to rest pans or trays on the internal glass pane.
- Do not pour water directly onto very hot trays.
- Make sure that the flame-spreader crowns are correctly positioned in their housings with their respective burner caps.
- The cooking vessels or griddle plates should be placed inside the perimeter of the hob.
- All pans must have smooth, flat bottoms.
- If any liquid does boil over or spill, remove the excess from the hob.

3.1 First use

1. Remove any protective film from the outside or inside of the appliance, including accessories.
2. Remove any labels (apart from the technical data plate) from the accessories and from the cooking compartments.
3. Remove all the accessories from the appliance and clean them (see 4 Cleaning and maintenance). Heat the empty ovens at the maximum temperature to burn off any residues left by the manufacturing process.

Oven cavity

4. Heat the empty oven at the maximum temperature for 1 hour to burn off any residues left by the manufacturing process.

Glass ceramic hob

5. Place a pan full of water on each of the front cooking zones and switch them on to the maximum power setting for at least 30 minutes.
6. After 30 minutes, switch off the front cooking zones and repeat this operation for the rear cooking zones and any central cooking zone.
7. If after carrying out the above operations the controls do not work properly, it might be necessary to extend the operations until the moisture has completely evaporated.

3.2 Using the accessories

Tray rack

The tray rack has to be inserted into the tray. In this way fat can be collected separately from the food which is being cooked.

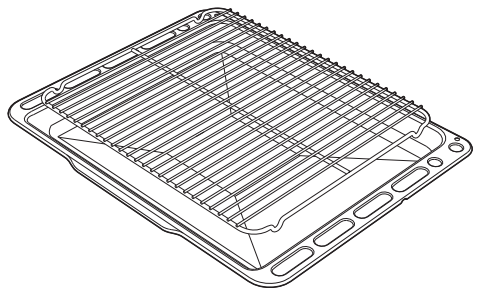





Racks and trays

Racks and trays have to be inserted into the side guides until they come to a complete stop.

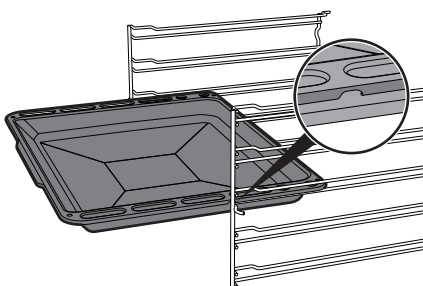
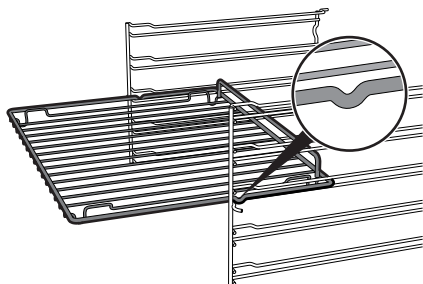
- The mechanical safety locks that prevent the rack from being taken out accidentally have to face downwards and towards the oven back.



3.3 Using the gas hob

All the appliance's control and monitoring devices are located together on the front panel. The burner controlled by each knob is shown next to the knob. The appliance is equipped with an electronic ignition device. Simply press the knob and turn it anti-clockwise to the maximum flame symbol, until the burner ignites. If the burner does not light in the first 15 seconds, turn the knob to  and wait 60 seconds before trying again. After lighting, keep the knob pressed in for a few seconds to allow the thermocouple to heat up. The burner may go out when the knob is released: In this case, the thermocouple has not heated up sufficiently. Wait a few moments and repeat the operation. Keep the knob pressed in longer.



In case of an accidental switching off, a safety device will be tripped, cutting off the gas supply, even if the gas cock is open. Return the knob to  and wait at least 60 seconds before lighting it again.



Gently insert racks and trays into the oven until they come to a stop.



Clean the trays before using them for the first time to remove any residues left by the manufacturing process.



Correct positioning of the flame-spreader crowns and burner caps

Before lighting the hob burners, make sure that the flame-spreader crowns are correctly positioned in their housings with their respective burner caps. Make sure that the holes in the flame-spreader crowns are aligned with the igniters and thermocouples (A).

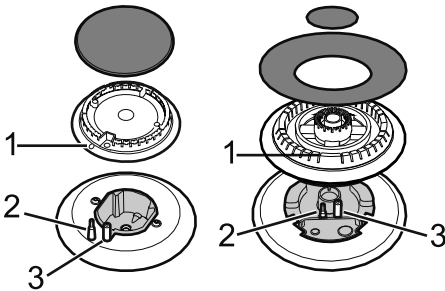

Practical tips for using the hob

For better burner efficiency and to minimise gas consumption, use pans with lids and of suitable size for the burner, so that flames do not reach up the sides of the pan. Once the contents come to the boil, turn down the flame far enough to ensure that the liquid does not boil over.



Cookware diameters:

- **SR:** 12 - 14 cm.
- **R:** 16 - 24 cm.
- **UR2 int + ext:** 18 - 28 cm

3.4 Using the induction hot plates



After use, turn off the hot plates used by returning the appropriate knob to the **O** position. Never rely solely on the cookware detector.



On first connection to the electrical mains, an automatic check will be carried out that will switch on all indicator lights for a few seconds.

All the appliance's control and monitoring devices are located together on the front panel. The relevant cooking zone is indicated next to each knob.

Just turn the knob clockwise to the required power setting.

Cookware suitable for use in induction cooking

Cookware used on the induction cooking surface must be made of metal, with magnetic properties and a sufficiently large base.

Suitable cookware:

- Enamelled steel cookware with thick bases.
- Cast iron cookware with an enamelled base.
- Cookware in multilayer stainless steel, ferritic stainless steel and aluminium with a special base.

Unsuitable cookware:

- Copper, stainless steel, aluminium, fireproof glass, wood, ceramic and terracotta cookware.
- To see whether the pan is suitable, bring a magnet close to the bottom: if it is attracted, the pan is suitable for induction cooking.



Use

If you do not have a magnet, you can put a small amount of water in the pan, place it on a cooking zone and start the hot plate.

To see whether the pan is suitable, bring a magnet close to the bottom: if it is attracted, the pan is suitable for induction cooking. If you do not have a magnet, you can put a small amount of water in the pan, place it on a cooking zone and start the hot plate. If the symbol  appears on the display, it means the pan is not suitable.

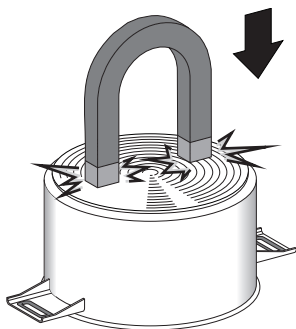

Cookware recognition

When there is no saucepan on a cooking zone or if the saucepan is too small, no energy will be transmitted and the symbol  will appear on the display.

If there is a suitable saucepan on the cooking zone, the recognition system notices it and turns on the hob to the power level set using the knob. Energy transmission is also interrupted when the saucepan is removed from the cooking zone (the symbol  will be shown on the display).

If the cookware recognition function is activated in spite of the saucepan or frying pan on the cooking zone being smaller than the zone itself, only the necessary energy will be transmitted.

Cookware recognition limits: The minimum diameter of the pan base is indicated by a circle inside the cooking zone. Pans with smaller diameters risk not being detected and therefore not activating the inductor.



Use only cookware with a perfectly flat bottom which is suitable for induction hot plates. Using cookware with an irregular bottom could jeopardise the efficiency of the heating system and prevent cookware from being detected on the cooking zone.



Limiting the cooking duration

The hob has an automatic device which limits the duration of use.

If the cooking zone settings are not changed, the maximum duration of operation for each zone depends on the power level selected.

When the device for limiting the duration of use is activated, the cooking zone turns off, a short alert sounds and, if the zone is hot, the symbol **H** appears on the display.

Set power level	Maximum cooking duration in hours
1	8
2	6
3 - 4	5
5	4
6 - 7 - 8 - 9	1 ½

Protection from overheating

If the hob is used on full power for a long period, the electronics will have trouble cooling down if the room temperature is high. To avoid excessively high temperatures forming in the electronics, the power to the cooking zone is reduced automatically.

Error codes

If the display shows one of the following error codes **C**, **E**, contact Technical Assistance.

Power levels

The power in the cooking zone can be adjusted to various levels. The table shows the levels suitable for various types of cooking.

Power level	Suitable for:
0	OFF setting
U	Keep warm
1 - 2	Cooking small amounts of food (minimum power)
3 - 4	Cooking
5 - 6	Cooking large quantities of food, roasting larger portions
7 - 8	Roasting, slow frying with flour
9	Roasting
p *	Roasting / browning, cooking (maximum power)

* see booster function

Residual heat



Improper use Danger of burns

- Supervise children carefully as they cannot easily see the residual heat indicator. The cooking zones remain hot for a certain period of time even after they have been turned off. Make sure that children never touch the hob.

If the cooking zone is still hot after being switched off, the symbol **H** will be displayed on the display. The symbol clears once the temperature drops below 60°C.



Use

Heating accelerator

i Each cooking zone is equipped with a heating accelerator that allows the maximum power to be delivered for a time that is proportional to the selected power.

This function allows the selected power to be achieved in the shortest amount of time.

1. Turn the knob anti-clockwise to position **A** and then release it. The display shows the symbol **A**.
2. Select the required heating power (**1 - 8**) within 3 seconds. The selected power and symbol **A** will flash alternately on the display.

The power level can be increased at any moment. The "maximum power" period will automatically be modified.

Once the acceleration period is over the power level will remain the same as the one previously selected.

 If the power is reduced, by turning the knob anti-clockwise, the heating accelerator will automatically be disabled.

Multizone function

i This function can be used to operate two cooking zones (front and rear) simultaneously when using pans like fish kettles or rectangular pans.

To activate the Multizone function:

1. Turn and hold the induction cooking zone knobs anticlockwise at the same time to position **M-A** until a short beep is emitted.

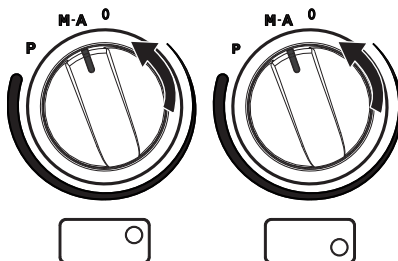

2. Turn the rear cooking zone knob back to position **9** and turn the front cooking zone knob to position **0**. A prolonged beep will be emitted.

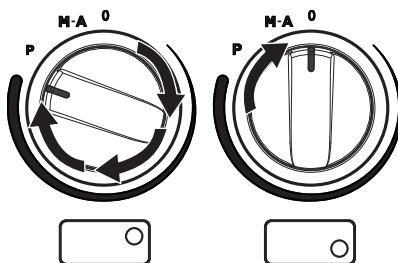



- Use the front cooking zone knob to set the required power level: this knob now controls both the cooking zones that are in use.

To deactivate the Multizone function:

- Put both knobs back to the **0** position (off).



This function automatically divides the power equally between both zones that are in use.

Controls lock



The controls lock is a device that protects the appliance from accidental or inappropriate use.

- With all cooking zones off, simultaneously turn the two cooking zone control knobs anti-clockwise to the left (position **A**).
- Keep them turned until the symbols  appear on the display.
- Release the knobs.

In order to remove the control lock repeat the same operations described previously.



If the knobs have been kept turned to the **A** position for more than 30 seconds a fault message appears on the display. 



After a prolonged period of interruption to the power supply, the control lock will be deactivated. If this is the case, turn it back on as described above.

Booster function



The booster function allows the cooking zone to be activated at maximum power for as long as 5 minutes. It can be used to bring a large quantity of water to a boil rapidly or to broil meat.

- Turn the knob clockwise to the **P** position for two seconds and then release.

The display shows the symbol . After 5 minutes the Booster function will automatically be disabled and cooking will continue at power level **9**.



The booster function has priority over the heating accelerator function.

Power control

The hob is fitted with a power control module that optimises/limits consumption. If the overall set power level exceeds the maximum limit permitted, the electronic circuit board will automatically manage the power supplied by the hot plates.

The module tries to maintain the maximum deliverable power levels. Levels set by the automatic control will appear on the display.



Use

The flashing of a power level indicates that it will be automatically limited to a new level selected by the power control module.

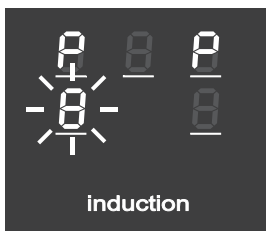

For grilling, cooking au gratin or as a barbecue.

- Turn the barbecue heating element knob to a setting between **1** and **9**. The light turns on to indicate that the heating element is on.



It is recommended that you pre-heat the element for 15 minutes before placing food on it.



Priority is given to the last zone set.

Barbecue plate



High temperature
Danger of burns

- After being used for a long time, the plate will remain hot even after the heating element has been switched off. Keep children away.
- Only remove the plate once it has cooled down.



High temperature
Risk of damaging the appliance

Do not use the barbecue plate without the hob guard.

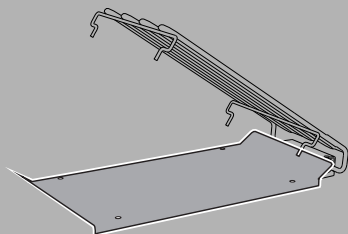



3.5 Using the ovens

Switching on the ovens

To switch on the ovens:

1. Select the cooking function using the function knob.
2. Select the temperature using the temperature knob.



Regular flashing of the thermostat indicator light during cooking is normal and indicates that the temperature is being maintained constant inside the oven.

Pyrolytic and humidified oven function list

ECO

Eco
This function is particularly suitable for cooking on a single shelf with low energy consumption.

Ideal for cooking meat, fish and vegetables. It is not recommended for leavened foods.

To obtain maximum energy savings and reduce cooking times, it is recommended to place food in the oven without preheating.



When using the ECO function, avoid opening the door during cooking.



Cooking (and preheating) times are longer with the ECO function.



The ECO function is a delicate cooking function and is recommended for food withstanding temperatures lower than 210°C; in case of cooking at higher temperatures, select another function.



Vapour Clean

This function makes cleaning easier using the steam produced by a little quantity of water poured onto the appropriate groove placed on the bottom. (see chapter "Cleaning and maintenance")



Convection

As the heat comes from above and below at the same time, this system is particularly suitable for certain types of food. Traditional cooking, also known as convection cooking, is suitable for cooking just one dish at a time. Perfect for all types of roasts, bread and cakes, and in any case, particularly suitable for fatty meats such as goose and duck.



Grill

The heat coming from the grill element gives perfect grilling results above all for thin and medium thickness meat and, in combination with the rotisserie (where fitted), gives the food an even browning at the end of cooking. Perfect for sausages, spare ribs and bacon. This function enables large quantities of food, particularly meat, to be grilled evenly.



Small grill (Pyrolytic oven only)

Using only the heat released from the central element, this function allows you to grill small portions of meat and fish for making kebabs, toasted sandwiches and any types of grilled vegetable side dishes



Fan assisted

The operation of the fan, combined with traditional cooking, ensures consistent cooking even with complex recipes. Perfect for biscuits and cakes, even when simultaneously cooked on several levels. (For multiple-level cooking, we recommend using the 2nd and 4th shelf).



Fan grill

The air produced by the fan softens the strong heatwave generated by the grill, grilling perfectly even very thick foods. Perfect for large cuts of meat (e.g. pork hock).



Baker's function

The combination of the fan with just the bottom heating element allows cooking to be completed more rapidly. This system is recommended for sterilising or for finishing off the cooking of foods which are already well-cooked on the surface, but not inside, which therefore need a little more heat. Perfect for any type of food.



Fan forced

The combination of the fan and the circular heating element (incorporated in the rear of the oven) allows you to cook different foods on several levels, as long as they need the same temperatures and same type of cooking. Hot air circulation ensures instant and even distribution of heat. It will be possible, for instance, to cook fish, vegetables and biscuits simultaneously (on different levels) without odours and flavours mingling.



Direct Steam (humidified oven only)

This function activates the central part of the lower heating element together with the circulaire heating element and fan, allowing the food to be cooked by the evaporation of the water in the tray. The fan evenly distributes the heat and steam that cooks the food delicately and keeps the appearance of the food and its nutrients unaltered.



Supercook (pyrolytic oven only)

The combination of fan assisted cooking and traditional cooking allows different foods to be cooked on several levels extremely quickly and efficiently, without odours and flavours mingling. Perfect for large volumes that call for intense cooking.



P **Pyrolytic (pyrolytic oven only)**
Setting this function, the oven reaches temperatures up to 500°C, destroying all the grease which forms on the internal walls.

3.6 Cooking with the Direct Steam function (humidified oven)

i Do not place food or any other object directly on the bottom of the oven. The base of the oven and the evaporation tray must always be left free.

1. Open the oven door.
2. Lift the cover of the evaporation tray.

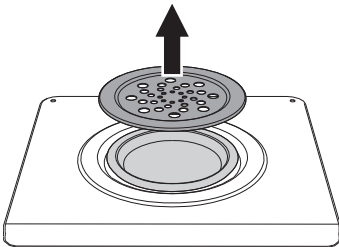

3. Fill the tray with sufficient water for the cooking duration (see Direct Steam cooking information table).

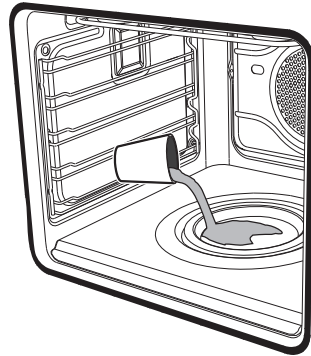

- Use cold tap water which is not too hard, softened water or still mineral water.
- Do not use distilled water, tap water with a high chloride content (> 40 mg/l), or other liquids.

The maximum level is indicated by a mark on the inside of the tray.

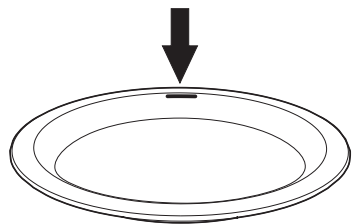

The maximum capacity of the evaporation tray is 250 ml.



Use

4. Put the cover back on the tray.
5. Place the food on the oven tray.
6. Place the tray with the food in the oven.
7. Select the Direct Steam function using the function knob.
8. Select the cooking temperature and time using the appropriate knobs.

4. Remove the cover from the evaporation tray inside the oven cavity, remove any remaining water and dry thoroughly.

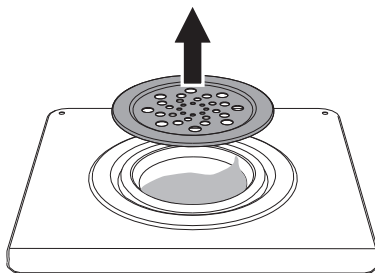

5. Use a sponge to remove any condensation from the base and walls of the oven cavity, the door glass and the drip tray at the front of the appliance.

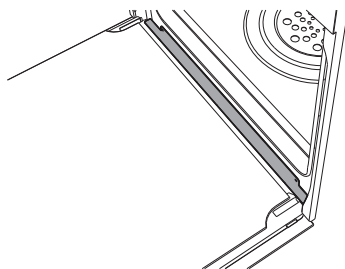

i For best results and to save energy, it is recommended to fill the tray with sufficient water for the required cooking.

End of Direct Steam cooking

1. Stand to the side of the appliance and open the door ajar for a few seconds to allow excess steam to escape.
2. Fully open the door when safe to do so and cautiously remove the food from the oven.
3. Wait for the appliance to cool down completely before cleaning it.

i Note: The evaporation tray cover may be very hot: use appropriate protection.

 If cooking has just been carried out with temperatures greater than 100°C, you must wait for the oven to cool in order to use the Direct Steam function.



Take care: the water may be very hot.



3.7 Using the temperature probe (pyrolytic oven)



High temperature of the temperature probe

Danger of burns

- Do not touch the rod or the tip of the probe after having used it.
- Wear oven gloves when handling the temperature probe.



Improper use

Risk of damage to surfaces

- Take care not to scratch or damage enamelled or chrome-plated surfaces with the tip or the plug of the temperature probe.



Improper use

Risk of damage to the appliance

- Do not insert the probe into openings and slots on the appliance.
- Only use the temperature probe provided or recommended by the manufacturer.
- When the probe is not in use, make sure that the protective cover is properly closed.



Improper use

Risk of injury

- Do not leave the temperature probe unattended.
- Do not allow children to play with the probe.
- Take care not to injure yourself on the sharp parts of the probe.



Improper use

Risk of damage to temperature probe

- Do not pull the cable to remove the probe from the socket or from the food.
- Make sure that the probe or its cable do not get caught in the door.
- No part of the probe should be allowed to come into contact with the walls of the oven cavity, the heating elements, the racks or the trays when they are still hot.
- When not in use, the probe should not be kept inside the appliance.
- Make sure the plug of the probe is fully inserted into the socket.
- Do not use the probe to place food into or to remove it from the oven cavity.

With the temperature probe, roasts, pork loin and various cuts and sizes of meat can be cooked to perfection.

The probe, in fact, allows foods to be cooked to perfection because it accurately monitors the core temperature of the food.



Use

The core temperature of the food is measured by a sensor located in the tip of the probe.

Positioning the probe

1. Place the food on a tray.
2. Insert the tip of the probe into the food before placing it in the oven.
3. For best results, make sure that the temperature probe is placed transversely in the thickest part of the food and for least 3/4 of its length. Make sure that it does not touch the tray underneath and that it does not protrude from the food.

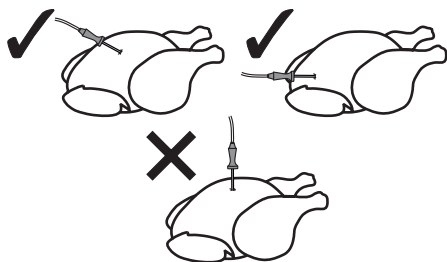

Cooking using the temperature probe

With preheating:

1. Set manual cooking (see “Turn the barbecue heating element knob to a position between 1 and 9. The light turns on to indicate that the heating element is on.”).
2. After preheating, open the door and insert the tray onto which the food has been placed into the appropriate guides.
3. Insert the plug of the probe into the socket at the side, using the probe to open the cover.



High temperature inside the oven during use
Danger of burns

- Wear oven gloves when handling the temperature probe.







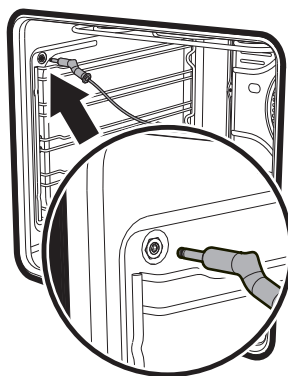

In order for the probe to measure the core temperature of the food precisely, its tip must not be in contact with bones or fat.





The minimum recommended oven temperature when cooking using the probe is 120°C.





4. Close the door.
5. Press the  button for a few seconds; Press the  button again. The default target temperature  is indicated on the display and the  symbol flashes.
6. Use the  and  buttons to regulate the target temperature to a value between the minimum and a maximum.

-  • **Minimum target temperature:** corresponds to the instantaneous temperature measured by the probe plus 2°C.
- **Maximum target temperature:** 99°C

7. Wait for a few seconds and then press the  button to display the instantaneous temperature measured by the probe.

Cooking will now continue until the instantaneous temperature measured by the probe is the same as the target temperature set by the user.



Without preheating:





1. Open the door.
2. Put the tray, on which the food has been placed with the probe in position, into the oven.
3. Insert the plug of the probe into the socket at the side, using the probe to open the cover.

4. Set the cooking using the probe as indicated in steps 5, 6 and 7 in the previous section.
5. Set manual cooking by selecting the temperature and cooking function (see "Switching on the ovens").

When cooking with the temperature probe is in progress

 When the temperature probe is used, it is not possible to set programmed cooking or timed cooking.

 When cooking with the temperature probe is in progress, the  and  buttons are disabled.

1. Press and hold the  button to activate the minute minder timer; press  again to display the target temperature and use the  and  buttons to adjust it while cooking is in progress.
2. Press  again or wait 5 seconds to return to cooking mode.



At the end of cooking

When the set target temperature for the temperature probe is reached, the heating elements are switched off and the appliance emits a series of beeps.

1. Press a button on the programmer clock to stop the buzzer.
2. Open the door.
3. Remove the probe from the food and unplug it from the socket.
4. Remove the food from the oven.
5. Make sure that the protective cover is properly closed.

3.8 Use of the storage compartments

There is a storage compartment located at the bottom of the cooker; this can be used to store pans or metal objects required to use the cooker. Press lightly on the sides of the door to open it.

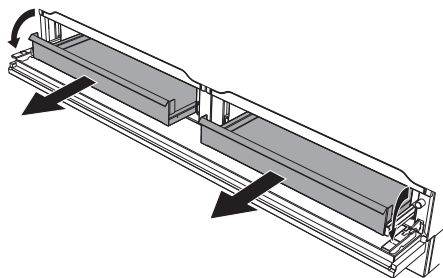

High temperature inside the storage compartment
Danger of burns

- The items inside the storage compartment could be very hot after using the oven.

3.9 Cooking advice

General advice

- Use a fan assisted function to achieve consistent cooking at several levels.
- It is not possible to shorten cooking times by increasing the temperature (the food could be overcooked on the outside and undercooked on the inside).

Advice for cooking meat

- Cooking times vary according to the thickness and quality of the food and to consumer taste.
- Use a meat thermometer when roasting meat, or simply press on the roast with a spoon. If it is hard, it is ready; if not, it needs another few minutes cooking.

Advice for cooking with the Grill and the Fan grill

- Meat can be grilled even when it is put into the cold oven or into the preheated oven if you wish to change the effect of the cooking.
- With the Fan grill function, we recommend that you preheat the oven before grilling.
- We recommend placing the food at the centre of the rack.
- With the Grill function, we recommend that you turn the temperature knob to the maximum value near the  symbol to optimise cooking.
- Foods should be seasoned before cooking. Foods should also be coated with oil or melted butter before cooking.
- Use the oven tray on the first bottom shelf to collect fluids produced by grilling.
- Grilling processes should never last more than 60 minutes.



Advice for cooking desserts/pastries and biscuits

- Use dark metal moulds: they help to absorb the heat better.
- The temperature and the cooking time depend on the quality and consistency of the dough.
- To check whether the dessert is cooked right through: at the end of the cooking time, put a toothpick into the highest point of the dessert. If the dough does not stick to the toothpick, the dessert is cooked.
- If the dessert collapses when it comes out of the oven, on the next occasion reduce the set temperature by about 10°C, selecting a longer cooking time if necessary.
- While cooking desserts or vegetables, excessive condensation may form on the glass. In order to avoid this, open the door very carefully a couple of times while cooking.

Advice for defrosting and proving

- Place frozen foods without their packaging in a lidless container on the first shelf of the oven.
- Avoid overlapping the food.
- To defrost meat, use the rack placed on the second level and a tray on the first level. In this way, the liquid from the defrosting food drains away from the food.
- The most delicate parts can be covered with aluminium foil.
- For successful proving, a container of water should be placed in the bottom of the oven.

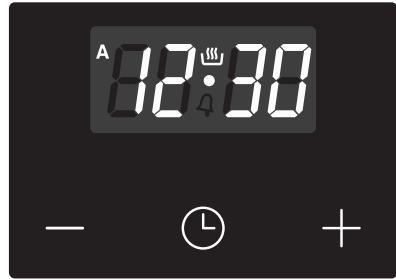

3.10 Programmer clock



 Value decrease button

 Clock button

 Value increase button

 Ensure that the programmer clock shows the cooking duration symbol , otherwise it will not be possible to turn on the oven. Press the  button to reset the programmer clock.



Use

Setting the time



When using the appliance for the first time or after a power failure, setting the time on one clock will set the same time on the other.



If the time is not set, the oven will not switch on.

On the first use, or after a power failure, the digits will be flashing on the appliance's display.

1. Hold down the clock button for two seconds. The dot between the hours and the minutes flashes.
2. The time can be set via the value increase button and value decrease button. Keep the button pressed in to increase or decrease rapidly.
3. Wait 7 seconds. The dot between the hours and the minutes stops flashing.
4. The symbol on the display indicates that the appliance is ready to start cooking.



Use the same clock that you used for the first time setting.



To change the time, hold down the value increase button and value decrease button at the same time for two seconds, then set the time.

Timed cooking



Timed cooking is the function which allows a cooking operation to be started and then ended after a specific length of time set by the user.

1. Keep the clock key pressed until the symbol appears.
1. Press the clock key again. On the display the symbol and the text appear, alternating with the current time.
2. Use the value increase and value decrease keys to set the required minutes of cooking.
3. Select a function and a cooking temperature.
4. Wait approx. 5 seconds without pressing any key in order for the function to activate. The current time and the symbols and will appear on the display.



At the end of cooking the heating elements will be deactivated. On the display, the symbol turns off, the symbol flashes and the buzzer sounds.

5. To turn the buzzer off, simply press one of the programmer clock keys.











6. Press the clock key  to reset the programmer clock.



 It is not possible to set a cooking time of more than 10 hours.



 To cancel the set programming press and hold down the value increase  and the value decrease  keys at the same time and then turn the oven off manually.

Programmed cooking







 Programmed cooking is the function which allows a cooking operation to be started at a set time and then ended after a specific length of time set by the user.

1. Set the cooking time as described in the previous point "Timed cooking".
2. Hold the menu key  down for 2 seconds.
3. Press the menu key  again. The display will show the digits  and the text  in sequence, while the  symbol flashes (for example, the current time is 17:30)
4. Use the  or  key to set the required minutes (for example 1 hour)

5. Press the menu key . The text  will appear on the display in sequence with the pre-set cooking duration added to the current time (for example, the cooking end time shown is 18:30).

6. Press the  or  key to set the cooking end time. (for example, 19:30).

 Bear in mind that a few minutes for oven preheating must be added to the cooking time.

7. Wait approx. 7 seconds without pressing any key in order for the function to activate. The current time will appear on the display, and the symbols  and  will turn off while the  indicator light comes on.
8. Select a cooking temperature and function.
9. At the end of cooking the heating elements will be deactivated. On the display, symbol  turns off, symbol  flashes and the buzzer sounds.
10. Return the function and temperature knobs to 0.
11. To turn off the buzzer just press any key of the programmer clock.
12. Press keys  and  at the same time to reset the set program.

 It is not possible to set a cooking time of more than 10 hours.





Use



It is not possible to set a programmed cooking time of more than 24 hours.









After setting, hold the menu key  down for 2 seconds to display the cooking time remaining. Press the menu key  again. The display shows the text  and the remaining cooking time in sequence.

Minute minder timer



The minute minder timer does not stop the cooking operation but rather informs the user when the set time has run out.

The minute minder timer can be activated at any time.

1. Keep the clock key  pressed for per a few seconds. The display shows the figures  and the symbol  flashing between the hours and minutes.
2. Use the value increase  and value decrease  keys to set the number of minutes required.
3. Wait approx. 5 seconds without pressing any key to finish setting the minute minder. The current time and the symbols  and  appear on the display.



A buzzer will sound when the set time is reached.

4. Press the value decrease key  to turn the buzzer off.





The minute minder timer can be set from 1 minute to a maximum of 23 hours and 59 minutes.

Modifying the set data





1. Press the clock key .
2. Use the value increase  and value decrease  keys to set the number of minutes required.

Deleting the set data

1. Press the clock key .
2. Hold down the value increase  and value decrease  keys at the same time.
3. Then switch off the oven manually if cooking is in progress.

Selecting the buzzer

The buzzer can have 3 tones.

1. Hold down the value increase  and value decrease  keys at the same time.
2. Press the clock key .
3. Press the value decrease key  to select a different buzzer tone.

7



Cooking information table

Food	weight (Kg)	Function	Runner position from the bottom	Temperature (°C)	Time (minutes)	
Lasagne	3 - 4	Convection	1	220 - 230	45 - 50	
Pasta bake	3 - 4	Convection	1	220 - 230	45 - 50	
Roast veal	2	Fan assisted	2	180 - 190	90 - 100	
Pork	2	Fan assisted	2	180 - 190	70 - 80	
Sausages	1,5	Fan grill	4	Max	15	
Roast beef	1	Fan assisted	2	200	40 - 45	
Roast rabbit	1,5	F.Assisted/F.Forced	2	180 - 190	70 - 80	
Turkey breast	3	Fan assisted	2	180 - 190	110 - 120	
Roast pork neck	2 - 3	Fan assisted	2	180 - 190	170 - 180	
Roast chicken	1,2	Fan assisted	2	180 - 190	65 - 70	
					1 st surface	2 nd surface
Pork chops	1,5	Fan grill	4	Max	15	5
Spare ribs	1,5	Fan grill	4	Max	10	10
Bacon	0,7	Grill	5	Max	7	8
Pork fillet	1,5	Fan grill	4	Max	10	5
Beef fillet	1	Grill	5	Max	10	7
Salmon trout	1,2	Fan assisted	2	150 - 160	35 - 40	
Delicate fish	1,5	Fan assisted	2	160	60 - 65	
Flounder	1,5	Fan assisted	2	160	45 - 50	
Pizza	1	Fan assisted	2	Max	8 - 9	
Bread	1	F.Assisted/F.Forced	2	190 - 200	25 - 30	
Focaccia	1	Fan assisted	2	180 - 190	20 - 25	
Ring cake	1	F.Assisted/F.Forced	2	160	55 - 60	
Jam tart	1	F.Assisted/F.Forced	2	160	35 - 40	
Ricotta cake	1	F.Assisted/F.Forced	2	160 - 170	55 - 60	
Jam tarts	1	Fan assisted	2	160	20 - 25	
Paradise cake	1,2	F.Assisted/F.Forced	2	160	55 - 60	
Profiteroles	1,2	Fan assisted	2	180	80 - 90	
Sponge cake	1	F.Assisted/F.Forced	2	150 - 160	55 - 60	
Rice pudding	1	Fan assisted	2	160	55 - 60	
Brioche	0,6	F.Assisted/F.Forced	2	160	30 - 35	

I tempi indicati in tabella non comprendono i tempi di preriscaldamento e sono indicativi.



Use

Direct Steam cooking information table



Food	Weight (Kg)	Water (ml)	Runner position from the bottom	Temperature (°C)	Time (minutes)
VEGETABLES					
Roast potatoes	1	80	2	210 - 220	40 - 45
Mixed roasted vegetables	0.6	80	2	210	35
REHEATING FOOD					
Pasta	0.3	100 - 110	2	120	15 - 25
Sliced roasted meats / spare	0.5	100 - 110	2	120	15 - 25
Bread	0.5	100 - 110	2	120	15 - 25
Strudel	0.5	100 - 110	2	120	15 - 25
DESSERTS/PASTRIES					
Bundt cake	1	60	2	160	50 - 55
Strudel	1	60	2	170	35 - 40
Muffins	40 g for each baking cup	60	2	160	15 - 17
Paradise cake	1	60	2	160	55 - 60
Sponge cake	1	60	2	160	60 - 65
Biscuits (0.5 cm thick)	total dough 0.3	60	2	170	18 - 20

The quantity of water recommended in the table may vary according to the type of food, weight and cooking time.

The oven is always preheated when the Direct Steam function is used.

Roasts, vegetables and potatoes should be mixed and/or turned during cooking to achieve uniform browning on all sides.

The times indicated in the table do not include preheating and are provided only as a guide.



Temperature probe-cooking information table

Type and cut of meat	Target temperature (°C)
Beef	
Roast beef: rare	50 - 53
Roast beef: medium	55 - 58
Roast beef: well done	65 - 70
Rib of beef: rare*	50
Rib of beef: medium*	58
Rib of beef: well done*	70
Pork	
Roast loin	70 - 80
Shoulder	80 - 85
Sausages**	75 - 80
Veal	
Veal roast	75 - 80
Poultry	
Whole chicken	80 - 85
Whole turkey	80 - 85
Roast turkey (whole or breast)	80 - 85
Lamb	
Leg of lamb with bone (rare)	65
Leg of lamb with bone (well done)	75 - 80
Slow cooking	
Beef / roast beef: rare***	50 - 54
Beef / roast beef: medium***	55 - 60

* Cooking times vary according to the thickness of the fillet.

** For sausages, it is recommended to select a suitable function to ensure they are well grilled externally.

*** It is recommended to brown the meat on each side in a pan for a few minutes before putting it in the oven.



4 Cleaning and maintenance

Instructions



Improper use

Risk of damage to surfaces

- Do not use steam jets to clean the appliance.
- Do not use cleaning products containing chlorine, ammonia or bleach on steel parts or parts with metallic finishes on the surface (e.g. anodizing, nickel- or chromium-plating).
- Do not use abrasive or corrosive detergents (e.g. scouring powders, stain removers and metallic sponges) on glass parts.
- Do not use rough or abrasive materials or sharp metal scrapers.
- Take care not to spill sugar or sweet mixtures onto the hob when hot. Never place materials or substances which may melt (plastic or aluminium foil) on the hob. If this occurs, promptly switch off the cooking zones and clean while the hot plate is still lukewarm to prevent damage to the surface.

4.1 Cleaning the appliance

To keep the surfaces in good condition, they should be cleaned regularly after use. Let them cool first.

Ordinary daily cleaning

Always use only specific products that do not contain abrasives or chlorine-based acids.

Pour the product onto a damp cloth and wipe the surface, rinse thoroughly and dry with a soft cloth or a microfibre cloth.

Food stains or residues

Do not use metallic sponges or sharp scrapers as they will damage the surfaces.

Use ordinary non-abrasive products with the aid of wooden or plastic utensils if necessary. Rinse thoroughly and dry with a soft cloth or a microfibre cloth.

Do not allow residues of sugary foods (such as jam) to set inside the oven. If left to set for too long, they might damage the enamel lining of the oven.

Cleaning the glass ceramic hob

Light coloured marks from pans with aluminium bases can be easily cleaned off with a cloth moistened in vinegar.

After cooking, remove any burnt residues with the scraper provided; rinse with water and dry thoroughly with a clean cloth. Regular use of the scraper considerably reduces the need for chemical detergents for the daily cleaning of the hob.

Dirt which may have fallen on the hob while cleaning lettuce or potatoes can scratch the hob when moving pans.

Consequently, remove any dirt from the cooking surface immediately.

Changes in colour do not affect the operation and stability of the glass. These are not alterations to the material of the hob but just residues which have not been removed and have then carbonised.

Shiny surfaces can form due to the bases of pans, especially aluminium ones, rubbing on the surface, and due to the use of unsuitable detergents. They are difficult to remove using conventional cleaning products. It may be necessary to repeat the cleaning process several times.



Use of corrosive detergents or rubbing of pan bases can wear away the decoration on the hob over time and contribute to the formation of stains.

Weekly cleaning

Clean and maintain the hob once a week using an ordinary glass ceramic cleaning product. Always follow the manufacturer's instructions. The silicon in these products creates a protective, water-repellent membrane which also resists dirt. All marks stay on the membrane and can therefore be removed easily. After cleaning, dry the surface with a clean cloth. Make sure that there is no detergent left on the cooking surface as it might undergo an aggressive reaction when heated up and could modify the structure of the cooking surface.

Cooking hob grids

Remove the grids and clean them with lukewarm water and non-abrasive detergent. Make sure to remove any encrustations. Dry them thoroughly and return them to the hob.



Continuous contact between the grids and the flame can cause modifications to the enamel over time in those parts exposed to heat. This is a completely natural phenomenon which has no effect on the operation of this component.

Cleaning the barbecue hob guard

1. Lift the heating element **A** and keep it in position using the stop **B**.

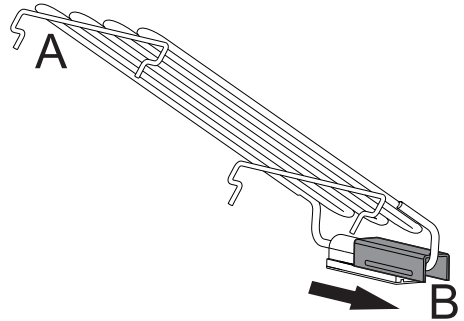

2. Clean the hob and the area underneath the heating element to remove residues, oil or grease stains.
3. Remove the heating element stop **B** and lower the heating element so that the four feet enter the holes in the hob.

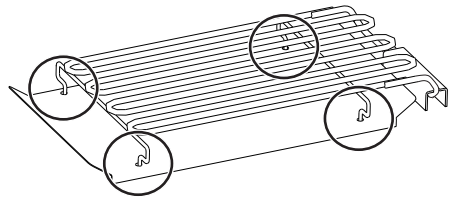

Flame-spreader crowns and burner caps

For easier cleaning, the flame-spreader crowns and the burner caps can be removed. Wash them in hot water and non-abrasive detergent. Carefully remove any encrustation, then wait until they are perfectly dry. Refit the flame-spreader crowns making sure that they are correctly positioned in their housings with their respective burner caps.

Igniters and thermocouples

For correct operation the igniters and thermocouples must always be perfectly



Cleaning and maintenance

clean. Check them frequently and clean them with a damp cloth if necessary. Remove any dry residues with a wooden toothpick or a needle.

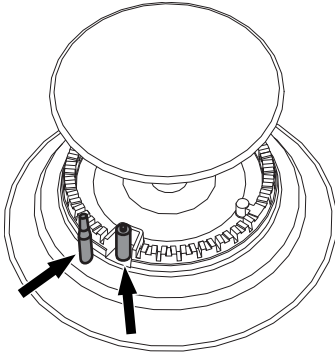

4.2 Removing the doors

For easier cleaning, the doors can be removed and placed on a tea towel or other protective sheet.

To remove the door proceed as follows:

1. Open the door completely and insert two pins into the holes on the hinges indicated in the figure.

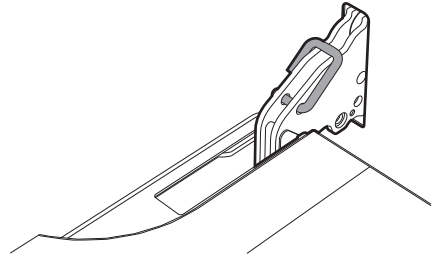

2. Grasp the door on both sides with both hands, lift it forming an angle of around 30° and remove it.

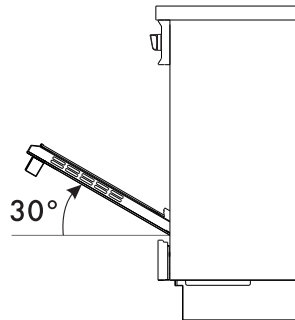



3. To reassemble the door, put the hinges in the relevant slots in the oven, making sure that grooved sections **A** are resting completely in the slots. Lower the oven door and once it is in position, remove the pins from the holes in the hinges.

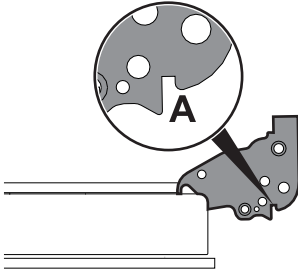

4.3 Cleaning the door glazing

The door glazing should always be kept thoroughly clean. Use absorbent kitchen roll. In case of stubborn dirt, wash with a damp sponge and an ordinary detergent.



We recommend the use of cleaning products distributed by the manufacturer.

4.4 Cleaning the inside of the ovens

To keep the ovens in perfect condition, clean them regularly after allowing them to cool.

- Take out all removable parts.

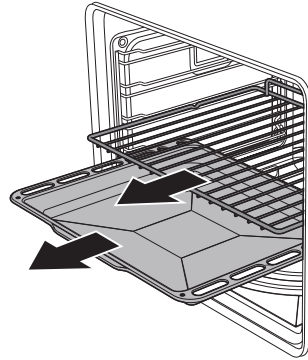

- Clean the oven racks with warm water and non-abrasive detergents. Carefully rinse and dry damp parts.



The ovens should be operated at the maximum temperature for about 15-20 minutes after using cleaning products, to burn off the residues left inside the oven.



For easier cleaning, it is recommended to remove the door.



Cleaning and maintenance

Removing racks/trays support frames

Removing the guide frames enables the sides to be cleaned more easily.

To remove the guide frames. Pull the frame towards the inside of the oven to unhook it from its groove **A**, then slide it out of the seats **B** at the back. When cleaning is complete, repeat the above procedures to put the guide frames back in.

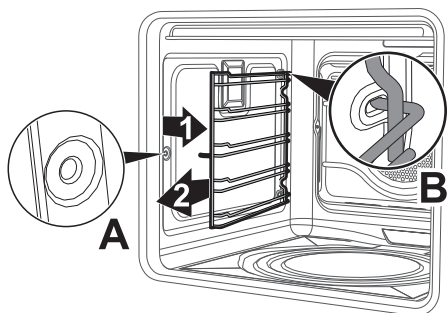

Vapour Clean (humidified oven)



Vapor Clean is an assisted cleaning procedure which facilitates the removal of dirt. Thanks to this process, it is possible to clean the inside of the oven very easily. The dirt residues are softened by the heat and water vapour for easier removal afterwards.



Improper use
Risk of damage to surfaces

- Remove any food residues or large spills from previous cooking operations from the inside of the oven.
- Carry out assisted oven cleaning operations only when the oven is cold.

Preliminary operations

Before starting the Vapor Clean cycle:

- Completely remove all accessories from inside the oven. The upper guard can be left inside the oven.
- Pour approx. 40 cc of water onto the bottom of the oven. Make sure it does not overflow out of the cavity.

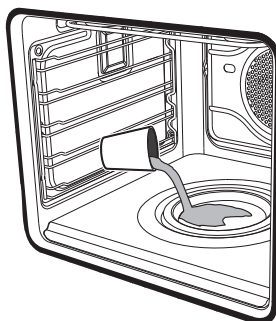



- Spray a water and washing up liquid solution inside the oven using a spray nozzle. Direct the spray against the side walls, upwards, downwards and towards the deflector.

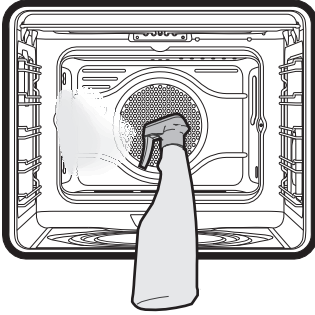



- Close the door.



We recommend spraying approx. 20 times at the most.

Vapor Clean cycle setting

1. Turn the function knob to the symbol  and the temperature knob to the symbol .
2. Set a cooking time of 18 minutes using the digital programmer.
3. At the end of the cooking time, the timer will switch the oven heating elements off and the buzzer will start to sound.

End of the Vapor Clean cycle

4. Open the door and wipe away the less stubborn dirt with a microfibre cloth.
5. Use a non-scratch sponge with brass filaments on hard to remove deposits.
6. In case of grease residues use specific oven cleaning products.
7. Remove the water left inside the oven.

For improved hygiene and to avoid food being affected by any unpleasant odours, we recommend that the oven is dried using a fan assisted function at 160°C for approximately 10 minutes.



We recommend wearing rubber gloves for these operations.



For easier manual cleaning of parts that are difficult to reach, we recommend removing the door.



Cleaning and maintenance

Cleaning the top of the compartment (humidified oven)



High temperature inside the oven during use

Danger of burns

- Protect your hands by wearing oven gloves when performing the following operations.

The appliance is equipped with a tilting grill element that allows for easy cleaning of the upper part of the oven compartment.

1. Free the upper heating element by gently lifting it and rotating its retaining latch by 90 degrees.

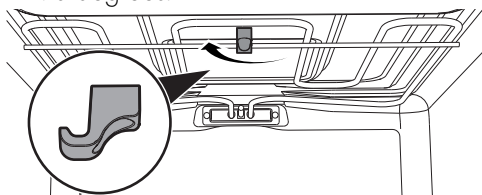

2. Gently lower the heating element until it stops.

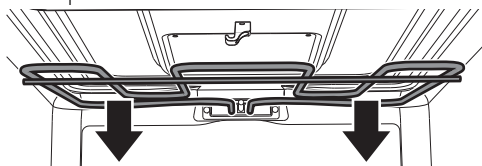

Improper use

Risk of damages to the appliance

- Do not excessively flex the element during cleaning.

When you have finished cleaning, place the heating element back in position and turn the retaining latch to lock it in place.

Cleaning the evaporation tray and cover (humidified oven)

It is recommended that you clean and dry the evaporation tray and the perforated cover after using the Direct Steam function.

Common cleaning products can be used: avoid using products that are too harsh and/or acidic.

The cover and the tray can be washed in a dishwasher.

If limescale forms, use a limescale remover for steel surfaces.

Cleaning the lower part (humidified oven)

It is recommended that you clean and dry the bottom of the oven after using the Direct Steam function:

1. Remove in sequence, the perforated cover (1), the evaporation tray (2) and the bottom (3); lift the bottom by a few millimetres and pull it outwards.

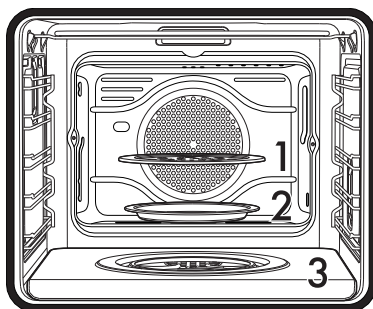



- Carefully lift the end of the lower heating element by a few centimetres and clean the bottom of the oven.

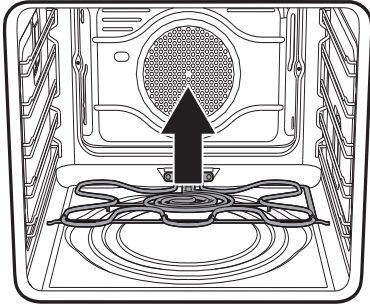

Put the heating element back into its seat when finished. Wait until the oven cavity is completely dry before putting back the accessories.

Deactivating the door lock lever manually (pyrolytic oven)



Improper use
Danger of burns

- The following operations must always be performed with the appliance cold and switched off.
- Never attempt to manually deactivate the door lock lever during a pyrolytic cycle.

The door lock lever is located in the first slot on the left under the control panel, in the upper part of the front of the oven.

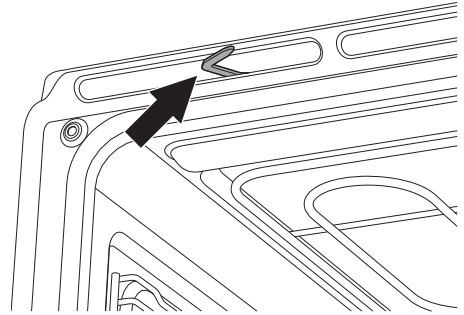

During normal cleaning operations, it is possible to accidentally activate the door lock lever.

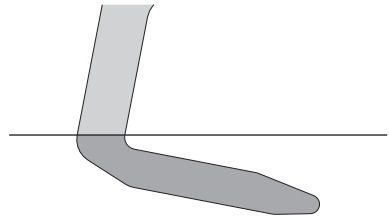

Door lock lever activated
(view from above)

- Move the door lock lever to the right until it stops.

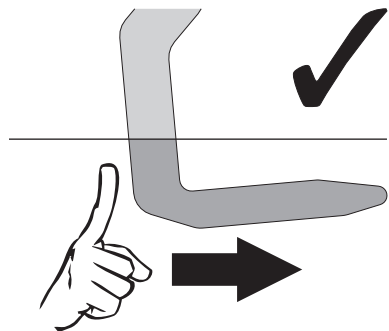

(view from above)



Cleaning and maintenance

2. Gently release the door lock lever.

The mechanism's spring will return the door lock lever to the deactivated position.

To prevent damage to the mechanism, never attempt to deactivate the door lock lever by forcing it to the left.

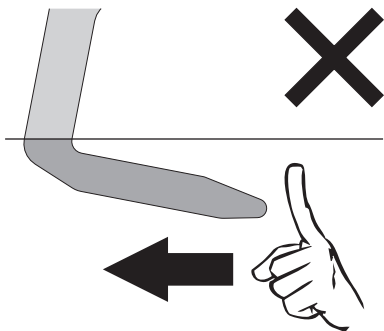

(view from above)

4.5 Pyrolytic cycle (pyrolytic oven)



Pyrolytic cleaning is an automatic, high-temperature cleaning procedure that causes dirt to dissolve. Thanks to this process, it is possible to clean the inside of the oven very easily.



Improper use Risk of damage to surfaces

- Remove any food residues or large spills from previous cooking operations from the inside of the oven.







- When this function is in use, the surfaces could reach temperatures that are higher than usual.
- Keep children at a safe distance.

Preliminary operations

Before starting the pyrolytic cycle:

- Clean the internal glass pane following the usual cleaning instructions.
- For very stubborn encrustations spray an oven cleaning product onto the glass (read the warnings on the product); leave for 60 minutes, then rinse and dry the glass using kitchen roll or a microfibre cloth.
- Remove all accessories from the oven cavity.
- Remove the rack/tray support frames.
- Close the door.

Pyrolytic function setting

1. Turn the function knob to the **P** symbol.  Will appear on the display alternating with the minimum pyrolytic cycle time (2 hours).
 2. Press the  or  button to set the duration of the cleaning cycle from a minimum of 2 hours to a maximum of 3 hours and 30 minutes.
-
- Recommended pyrolytic cycle duration:
- Light dirt: 2 hours.
 - Medium dirt: 2 hours 45 minutes.
 - Heavy dirt: 3 hours 30 minutes.
3. Press the  button to confirm the start of the pyrolytic cycle.



4. One minute after the pyrolytic cycle has started, the door is locked (the door lock light lights up) by a device that prevents it from being opened.







It is not possible to select any function once the door lock device has been activated.

5. At the end of the pyrolytic cycle, all the numbers on the display will flash and a buzzer will sound to indicate the end of the automatic cleaning cycle.
6. Move the function knob back to the "0" position.
7. The door remains locked as long as the temperature inside the oven returns to safety levels.
8. Wait for the oven to cool down and collect the residues deposited inside with a damp microfibre cloth.

Setting of programmed pyrolytic cycle

It is possible to program the pyrolytic cycle start time like all other cooking functions.

1. After having started the pyrolytic cycle (see "Pyrolytic function setting"), press and hold the  button for 2 seconds.
2. Continue to press the  button until  appears on the display.
3. Press the  and  buttons within 5 seconds to set the time at which you want the cleaning cycle to end.

4. Press the  button to confirm the settings.



Be careful not to turn the function knob when setting the pyrolytic cycle. If you do, the settings entered via the programmer clock will be deleted and you will have to reset them.



During the first pyrolytic cycle, unpleasant odours may occur due to the normal evaporation of oily manufacturing substances. This is an absolutely normal phenomenon which disappears after the first pyrolytic cycle.



During the pyrolytic cycle the fans produce a more intense level of noise due to a greater rotation speed. This is an absolutely normal operation, intended to provide more effective heat dispersal. At the end of the pyrolytic cycle, the fans will continue to operate for long enough to avoid overheating the walls of adjacent units and the front of the oven.



Cleaning and maintenance

4.6 Extraordinary maintenance



Electrical parts
Danger of electrocution

- Turn off the power supply of the oven.
- Use protective gloves.

Replacing the oven light bulb



Live parts
Danger of electrocution

- Unplug the appliance.



The oven is fitted with a 40W light bulb.

1. Completely remove all accessories from inside the oven.
2. Remove the racks/trays support frames.
3. Remove the bulb cover using a tool (e.g. a screwdriver).



Pay attention not to scratch the oven cavity enamel.

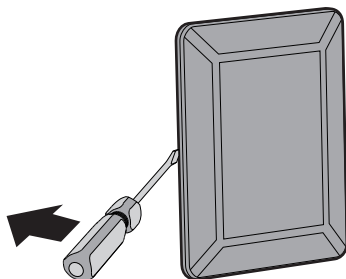

4. Slide out and remove the light bulb.

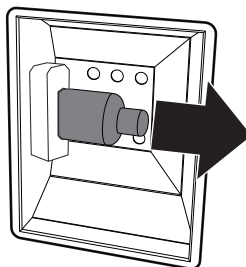

Do not touch the halogen light bulb directly with your fingers, but wrap it in insulating material.

5. Fit the new light bulb.
6. Refit the cover. Ensure the moulded part of the glass (A) is facing the door.

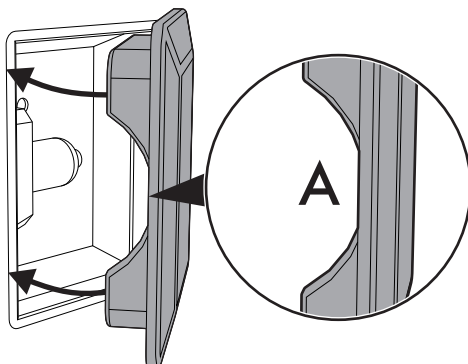

7. Press the cover completely down so that it attaches perfectly to the bulb support.



Removing and installing the oven seal (humidified oven)

To remove the oven seal:

- Unhook the clips in the 4 corners, then pull the oven seal.

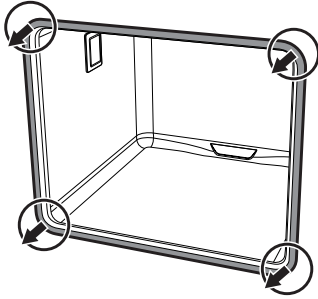

To install the oven seal:

- Hook the clips in the 4 corners and in the centre onto the oven seal.

Oven seal maintenance tips

The seal should be soft and elastic.

To keep the oven seal clean, use a non-abrasive sponge and lukewarm water to wash it.

What to do if...

The appliance does not work.

- The circuit breaker is faulty: look in the fuse box and check that the circuit breaker is in working order.
- Power cut: check whether the kitchen light works.

The oven does not heat up.

- Faulty fuse: check and, if required, replace the circuit breaker.
- The function knob has not been set: set the function knob.

All dishes that are prepared in the oven burn within an extremely short period of time.

- Faulty thermostat: call the Authorised Assistance Centres.

The door panel steams up when the oven is hot.

Normal occurrence caused by the difference in temperature: this has no effect on oven performance.



Annual service by an authorised person is recommended, or if any of the following conditions are noticed; incomplete ignition, appreciable yellow tipping, carbon deposition, lifting, floating, lighting back or objectionable odour.



Installation

5 Installation

5.1 Minimum clearance to combustible surfaces

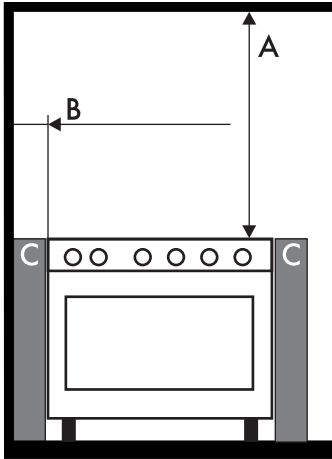

A 600 mm (Overhead) measured from the highest part of the highest burner and 750 mm for an exhaust fan.

B 200 mm (Vertical combustible surface) measured from the edge of the nearest burner.

C 10 mm (Horizontal combustible surface) below the hob.

 Refer to AS/NZS 5601 (Protection of a combustible surface) if the above minimum clearances cannot be achieved.

 The appliance connection point shall be accessible with the appliance installed.

5.2 Gas connection



Gas leak
Danger of explosion

- After carrying out any operation, check that the tightening torque of gas connections is between 10 Nm and 15 Nm.
- If required, use a pressure regulator that complies with current regulations.
- At the end of the installation, check for any leaks with a soapy solution, never with a flame.

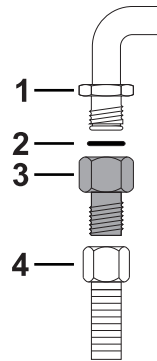

Carefully screw the hose connector **3** to the appliance's gas connector **1** (1/2" thread ISO 228-1), placing the supplied seal **2** between them.

This appliance must be installed by an authorised person in accordance with this instruction manual, AS/NZS 5601.1 - Gas installation (installation and pipe sizing), local gas fitting regulations, local electrical regulations, local health regulations, Building Code of Australia and any other government authority.



This appliance is suitable for connection with rigid pipe or flexible hose. The isolating manual shut-off valve connection point must be accessible when the appliance is installed.

Flexible hose assembly must be certified to AS/NZS 1869 class B or D, be of appropriate internal diameter for the total gas consumption (10mm), be kept as short as possible (not exceeding 1200mm), must not be in contact with the floor or any hot surface or sharp surface. The hose assembly must not be subject to strain, abrasion, kinking, deformation, contact with any other appliance or accidental contact with oven flue outlet of an under bench oven.

Gas leakage and operation of the appliance must be tested by the installer before leaving. Check burner flames are blue in colour, stable and completely ignite at both high and low flame settings with no appreciable yellow tipping, carbon deposition, lifting, floating, lighting back or objectionable odour. Test burners individually and in combination, When satisfied with the operation of the cooker, please instruct the user on the correct method of operation.

Natural Gas: the regulator must be fitted to the appliance inlet connection. Gas pressure must be adjusted to 1.0 kPa when approximately 50% of the burners are on high flame, the appliance test point is located on the regulator.

Universal LPG: gas pressure must be checked to confirm the appliance operating pressure is 2.75 kPa.

1. Disconnect power.
2. Light the auxiliary burner and set to high flame. Ensure all other burners are off.
3. Zero manometer, then apply flexible tubing to seal over the Rapid burner injector, hold securely in place and check the gas pressure by pressing in the corresponding burner control knob in, then turning to high flame position.
4. If the pressure is 2.75 kPa, reassemble the burner and perform the final checks as per this instruction manual.
5. If the pressure is not 2.75 kPa, disconnect the appliance and check/adjust/replace the LPG cylinder regulator(s) as appropriate in accordance with AS/NZS 5601.

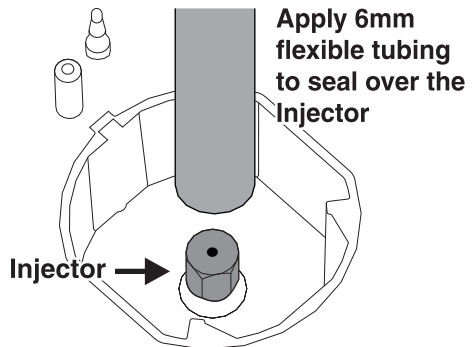

Patent 2015101170. For enquiries contact Gas Approval Consulting Pty Ltd
Smeg license 018 for SAI Global GAS40047



Installation

Room ventilation

The room containing the appliance should have a permanent air supply in accordance with the standards in force. The room where the appliance is installed must have enough air flow needed for the regular combustion of gas and the necessary air change in the room itself. The cooktop shall be installed in rooms with natural ventilation, as required by Standards regulations AS/NZS5601.

Extraction of the combustion products



This appliance is not connected to an exhaust system for combustion products. It must be installed and connected in compliance with the current installation regulations. Special attention should be paid to the relevant requirements as for ventilation.

Combustion gases may be discharged by means of hoods connected to a flue with reliable natural draught, or a fan extraction system. An effective extraction system requires careful design by an authorised specialist, and must comply with the regulation distances and positions.

After installation, the engineer must issue a certificate of compliance.

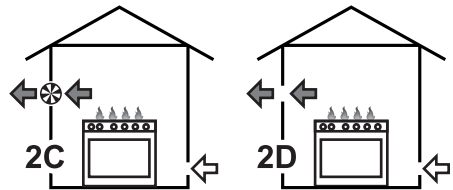
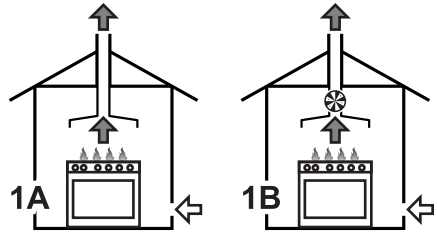

- 1 Extraction using a hood.
- 2 Extraction without a hood.
- A Single natural draught chimney.
- B Single chimney with extractor fan.
- C Directly outdoors with wall- or window-mounted extractor fan.
- D Directly outdoors through wall.

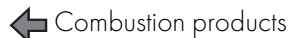

5.3 Adaptation to different types of gas

In case of operation with other types of gas, the burner nozzles must be changed and the minimum flame adjusted on the gas valves.

Replacing nozzles

1. Remove the grids, burner caps and flame-spreader crowns to access the burner cups.



2. Reposition the nozzles using a 7-mm spanner according to the gas to be used (see "Burner and nozzle specifications tables").

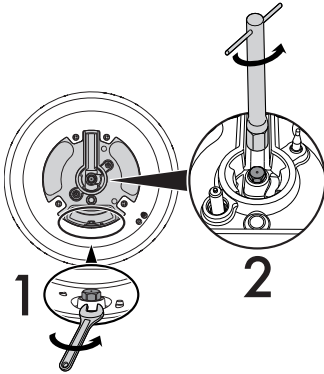

1 External nozzle - 2 Internal nozzle

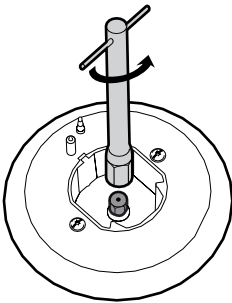

3. Reposition the burners in their respective housings.

Adjusting the minimum setting for natural gas

Light the burner and turn it to the minimum position. Extract the gas valve knob and turn the adjustment screw next to the valve rod (depending on the model) until the correct minimum flame is achieved.

Refit the knob and verify that the burner flame is stable. Turn the knob rapidly from the maximum to the minimum setting: the flame should not go out. Repeat the operation on all gas valves.

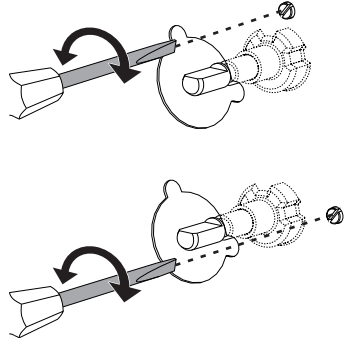

Adjusting the minimum setting for LPG

Tighten the screw located at the side of the valve rod clockwise all the way.



Following adjustment to a gas other than the one originally set in the factory, replace the gas setting label on the appliance with the one corresponding to the new type of gas. The label is inserted inside the nozzle pack (where fitted).

Lubricating the gas valves

Over time the gas valves can become difficult to turn and get blocked. Clean them internally and replace the lubrication grease.



Lubrication of the gas valves be performed by a specialised technician.



Installation

Burner and nozzle specifications tables

1 ULPG 2.75 kPa	SR	R	DUAL int. + ext.
Nominal gas consumption (MJ/h)	6.3	10.8	15.2
Injector (1/100 mm)	0.68	0.88	0.46 + 0.94
2 NG 1.0 kPa	SR	R	DUAL int. + ext.
Nominal gas consumption (MJ/h)	7.5	12	15.2
Injector (1/100 mm)	1.20	1.55	0.80 + 1.65

5.4 Positioning



**Heavy appliance
Crushing hazard**

- Position the appliance into the cabinet cut-out with the help of a second person.



**Pressure on the open door
Risk of damage to the appliance**

- Never use the oven door to lever the appliance into place when fitting.
- Avoid exerting too much pressure on the oven door when open.



**Heat production during appliance
operation
Risk of fire**

- Veneers, adhesives or plastic coatings on adjacent furniture should be temperature-resistant (not less than 90°C).

Appliance dimensions: position of gas and electrical connections

Position of gas and electrical connections (measurements given in mm).

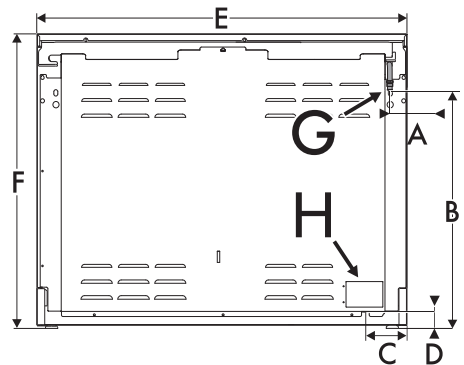

A	56
B (max)	770
B (min)	744
C	135
D	55
E	1200
F (min)	920
F (max)	894

G = gas connection

H = electrical connection



Positioning and levelling the appliance

After making the electrical and/or gas connections, properly level the appliance on the floor to ensure better stability. Screw or unscrew the bottom part of the leg until the appliance is stable and level on the floor.

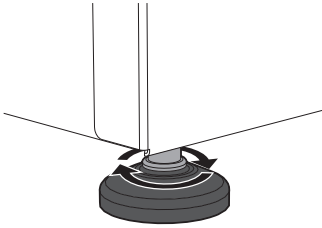

2. Align the front plinth with the corresponding holes on the appliance.

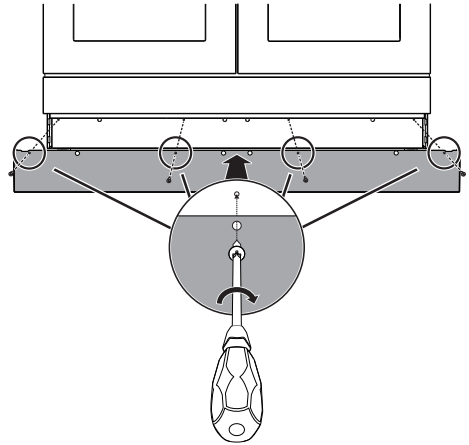

Installing the front plinth

The front plinth must always be positioned and secured correctly on the appliance.

1. Use a screwdriver to remove the front screws under the storage compartment door.

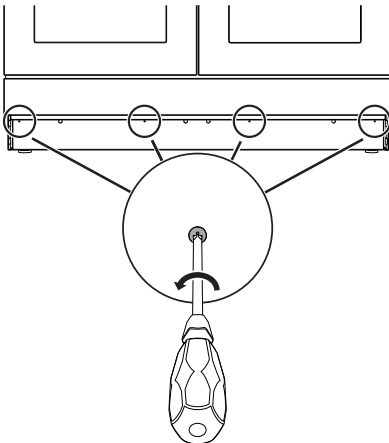

3. Fasten the front plinth using the screws that were previously removed.

Installing the side plinth

After having installed the front plinth, you should also install the side plinths.

1. Position the side plinths at the side of the front plinth.
2. Insert the tabs into the slots behind the ends of the front plinth.

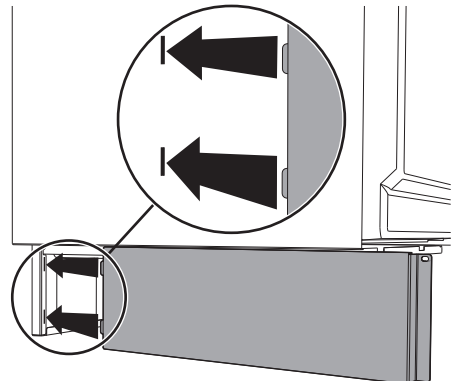



Installation

3. Align the holes on the back of the side plinths with those on the base of the appliance.

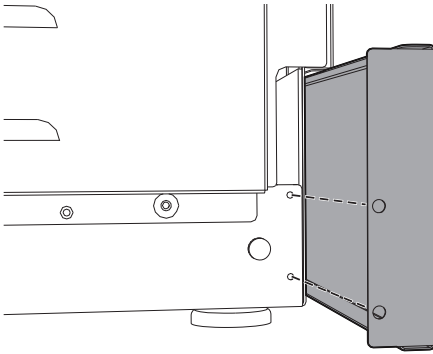

4. Fasten the side plinth using a screw.

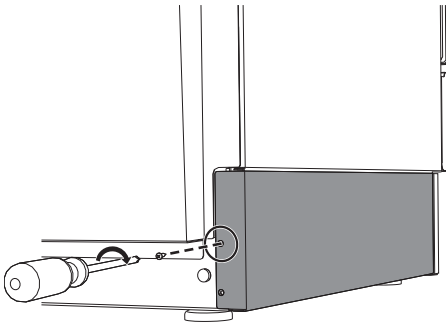

5. Make sure that you fasten both plinths following the instructions provided.

Assembling the upstand

i The upstand provided is an integral part of the product. It must be fastened to the appliance prior to installation.

The upstand must always be positioned and secured correctly on the appliance.

1. Position the upstand on the hob, and align the screw holes.
2. Secure the upstand to the hob using the fixing screws.

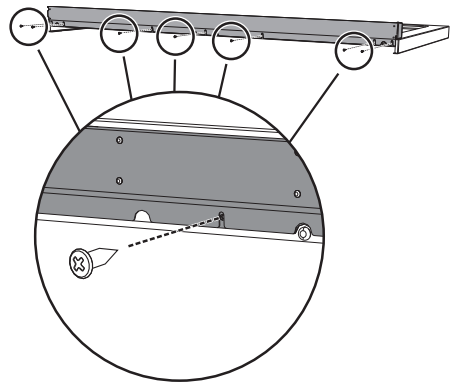



5.5 Electrical connection



Power voltage Danger of electrocution

- Have the electrical connection performed by authorised technical personnel.
- Use personal protective equipment.
- The appliance must be connected to earth in compliance with electrical system safety standards.
- Disconnect the mains power supply.
- Do not pull the cable to unplug the appliance.
- Use cables withstanding a temperature of at least 90°C.
- The tightening torque of the screws of the terminal supply wires must be 1.5 - 2 Nm.

- an appropriately rated installation male connector that is compatible with the installation female connector fitted to the final sub-circuit in the fixed wiring that supplies this cooking range.

The appliance can work in the following modes:

- **220-240 V 1N~**

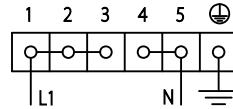

3 x 6 mm² three-core cable.

- **380-415 V 2N~**

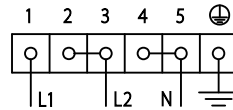

4 x 2.5 mm² four-core cable.

- **380-415 V 3N~**

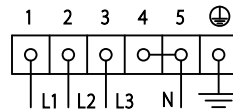

5 x 2.5 mm² five-core cable.

General information

Check the grid characteristics against the data indicated on the plate.

The identification plate bearing the technical data, serial number and brand name is visibly positioned on the appliance.

Do not remove this plate for any reason.

Perform the ground connection using a wire that is 20 mm longer than the other wires.

For New Zealand only: If this cooking range is to be connected to a new or upgraded electrical installation, then it must be connected to the supply by a supply cord fitted with:

- an appropriately rated plug that is compatible with the socket-outlet fitted to the final sub-circuit in the fixed wiring that supplies this cooking range; or



The values indicated refer to the cross-section of the internal conductor.



The aforementioned power cables are sized taking into account the coincidence factor (in compliance with standard EN 60335-2-6).



Installation

Accessing the terminal board

To connect the power supply cable, you must access the terminal board on the rear casing:

1. Remove the screws fastening the plate to the rear casing.

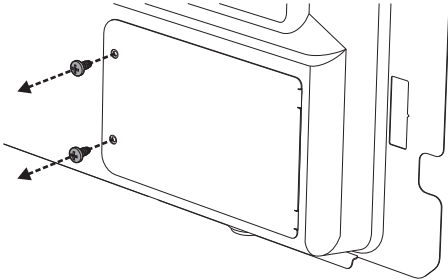

2. Gently rotate the plate and remove it from its seat.

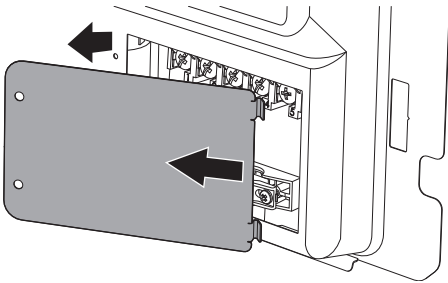

3. Proceed with installation of the power supply cable.

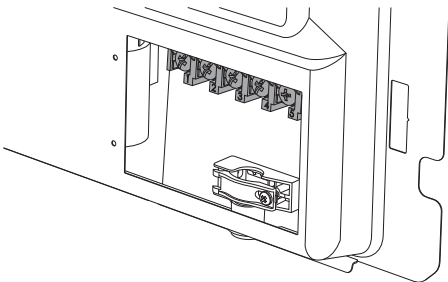

It is recommended to slacken off the cable clamp screw before installing the power supply cable.

4. When finished, replace the plate on the rear casing and secure it in place using the screws that were previously removed.

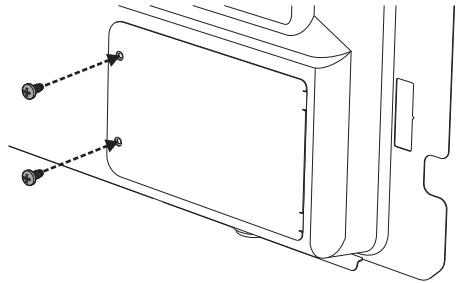

Fixed connection

Fit the power line with an all-pole circuit breaker with a contact separation distance sufficient to provide complete disconnection in category III overvoltage conditions, pursuant to installation regulations.

The circuit breaker should be located near the appliance and in an easily reachable position.

Testing

At the end of installation, carry out a brief inspection test. If the hob fails to operate, after checking that you have carried out the instructions correctly, unplug the appliance and contact Technical Support.



5.6 Instructions for the installer

- The plug must be accessible after installation. Do not bend or trap the power cable.
- The appliance must be installed according to the installation diagrams.
- Do not try to unscrew or force the threaded elbow of the fitting. You may damage this part of the appliance, which may void the manufacturer's warranty.
- Use soap and water to check for gas leaks on all connections. **DO NOT** use naked flames to find leaks.
- Turn on all the burners separately and at then all together to make sure that the gas valve, burner and ignition are working properly.
- Turn the burner knobs to the minimum position and check that the flame is stable for each individual burner and all the burners together.
- If the appliance does not work correctly after having carried out all the checks, contact your local Authorised Service Centre.
- Once the appliance has been installed, please explain to the user how to use it correctly.
- For stationary appliances permanently connected to the fixed wiring, compliance with this requirement is considered to be met if the instructions concerning disconnection incorporated in the fixed wiring is in accordance with AS/NZS 3000.



914779302/E