



OWNER'S MANUAL

REFRIGERATOR

Read this owner's manual thoroughly before operating the appliance and keep it handy for reference at all times.

EN ENGLISH

GF-L708BSL

GF-L708PL

GF-D708BSL

GF-D708MBSL



MFL70407906
Rev.00_121517

www.lg.com

Copyright © 2017 LG Electronics Inc. All Rights Reserved.

TABLE OF CONTENTS

This manual may contain images or content different from the model you purchased.

This manual is subject to revision by the manufacturer.

SAFETY INSTRUCTIONS	3
IMPORTANT SAFETY INSTRUCTIONS	3
INSTALLATION	13
Compartments	13
Notes for Movement and Transport	14
Notes for Installation	14
Dimensions and Clearances	15
Ambient Temperature	15
Removing the Door	16
Adjusting the Height of the Door	18
Adjusting a Tilted Appliance	20
Connecting the Water Line	20
OPERATION	22
Parts and Functions	22
Notes for Operation	26
Control Panel	28
Extra Space (Optional)	30
Door Mullion	30
Door in Door (some models only)	30
Moving Basket (Optional)	31
Mini Table (Optional)	31
Fresh Zone (Optional)	31
Water and Ice Dispenser	32
Automatic Ice maker	32
Removing the Ice Storage Bin	33
SMART FUNCTIONS	34
Using the LG SmartThinQ Application	34
Using Smart Diagnosis™	36
MAINTENANCE	37
Notes for Cleaning	37
Replacing the Pure N Fresh Filter (Optional)	38
Cleaning the Shelf	39
Cleaning the Vegetable Box	39
Cleaning the Fridge/Freezer Basket	40
Cleaning the Door in Door	41
Cleaning the Mini Table	42
Cleaning the Freezer Tray/Drawer	43
Cleaning the Water Dispenser	43
Replacing the Water Filter	44
TROUBLESHOOTING	45

SAFETY INSTRUCTIONS

EN

The following safety guidelines are intended to prevent unforeseen risks or damage from unsafe or incorrect operation of the appliance.

The guidelines are separated into 'WARNING' and 'CAUTION' as described below.

 This symbol is displayed to indicate matters and operations that can cause risk. Read the part with this symbol carefully and follow the instructions in order to avoid risk.

 **WARNING**

This indicates that the failure to follow the instructions can cause serious injury or death.

 **CAUTION**

This indicates that the failure to follow the instructions can cause the minor injury or damage to the product.

IMPORTANT SAFETY INSTRUCTIONS

 **WARNING**

To reduce the risk of explosion, fire, death, electric shock, injury or scalding to persons when using this product, follow basic precautions, including the following:

Children in the Household

- This appliance is not intended for use by persons (including children) with reduced physical, sensory or mental capabilities, or lack of experience and knowledge, unless they have been given supervision or instruction concerning use of the appliance by a person responsible for their safety. Children should be supervised to ensure that they do not play with the appliance.

- If the appliance is equipped with a lock (some countries only), keep the key out of reach of children.

Installation

- This appliance should only be transported by two or more people holding the appliance securely.
- Ensure that the outlet socket is properly earthed, and that the earth pin on the supply cord is not damaged or removed from the plug. For more details on earthing, inquire at an LG Electronics customer information centre.
- This appliance is equipped with a power cord having an equipment-grounding conductor (earthing pin) and a grounding power plug. The power plug must be plugged into an appropriate socket outlet that is installed and grounded in accordance with all local codes and ordinances.
- If the power cord is damaged or the outlet socket are loose, do not use the power cord and contact an authorized service centre.
- Do not plug the appliance into a multi socket adapter which does not have a power cable(mounted). Failure to do so may result in fire.
- Do not plug the appliance into a multiple outlet power board or an extension power cable.
- Do not modify or extend the power cord.

- Avoid using any extension cords or double adaptor. The appliance should be connected to a dedicated power line which is separately fused.
- Do not use a multi socket outlet which is not properly grounded(portable). In case of using a properly-grounded multi socket outlet (portable), use the multi socket outlet with the current capacity of the power code rating or higher and use the multi socket outlet only for the appliance. Failure to do so may result in electric shock or fire due to the heat of multi socket outlet. The power may be shut off when the circuit breaker is operated.
- Install the appliance in a place where is easy to unplug the power plug of the appliance.
- Be careful not to point the power plug up or let the appliance lean against the power plug.
- Install the appliance on a firm and level floor.
- Do not install the appliance in a damp and dusty place. Do not install or store the appliance in any outdoor area, or any area that is subject to weathering conditions such as direct sunlight, wind, or rain or temperatures below freezing.
- Do not place the appliance in direct sunlight or expose it to the heat from heating appliances such as stoves or heaters.
- Be careful not to expose the rear of the appliance when installing.
- Be careful not to let the appliance door fall during assembly or disassembly.
- Be careful not to pinch, crush, or damage the power cable during assembly or disassembly of the appliance door.
- Do not connect a plug adaptor or other accessories to the power plug.

Operation

- Do not use the appliance for any purpose (storage of medical or experimental materials or shipping) other than any domestic household food storage use.
- In case of flood, disconnect the power plug and contact the LG Electronics customer information centre.
- Unplug the power plug during a severe lightning or thunderstorm or when not in use for a long period of time.
- Do not touch the power plug or the appliance controls with wet hands.
- Do not bend the power cable excessively or place a heavy object on it.
- If water penetrates electrical parts of the appliance, disconnect power plug and contact an LG Electronics customer information centre.
- Do not place hands or metallic objects inside the area emitting the cold air, cover or heat releasing grille on the back.
- Do not apply excessive force or impact to the back cover of the appliance.
- Do not put animals, such as pets into the appliance.
- Be careful of nearby children when you open or close the appliance door. The door may bump the child and cause injury. Do not allow any persons to swing from any of the doors as it can cause the unit to topple over and cause serious injury.
- Avoid the danger of children getting trapped inside the appliance. A child trapped inside the appliance can cause suffocation.
- Do not place heavy or fragile objects, liquid filled containers, combustible substances, or flammable objects (such as candles, lamps, etc.), or heating devices (such as stoves, heaters, etc.) on the appliance.

- If there is a gas leakage (isobutane, propane, natural gas, etc.), do not touch the appliance or power plug and ventilate the area immediately. This appliance uses a very eco-friendly gas (isobutane, R600a) as the refrigerant. Although it uses a small amount of the gas, it is still combustible gas. Gas leakage during appliance transport, installation or operation can cause fire, explosion or injury if sparks are caused.
- Do not use or store flammable or combustible substances (ether, benzene, alcohol, chemical, LPG, combustible spray, insecticide, air freshener, cosmetics, etc.) near the appliance.
- Immediately unplug the power plug and contact an LG Electronics customer information centre if you detect a strange sound, odour, or smoke coming from the appliance.
- Fill with potable water only into icemaker or dispenser water tank.

Maintenance

- Disconnect the power cord before cleaning the appliance or replacing the inside lamp (where fitted).
- Securely plug the power plug in the outlet socket after completely removing any moisture and dust.
- Never unplug the appliance by pulling on the power cable. Always grip the power plug firmly and pull straight out from the outlet socket.
- Do not spray water or inflammable substances (toothpaste, alcohol, thinner, benzene, flammable liquid, abrasive, etc.) over the interior or exterior of the appliance to clean it.
- Do not clean the appliance with brushes, cloths or sponges with rough surfaces or which are made of metallic material.

- Only qualified service personnel from LG Electronics service centre should disassemble, repair, or modify the appliance. Contact an LG Electronics customer information centre if you move and install the appliance in a different location.
- Do not use a hair drier to dry the inside of the appliance or place a candle inside to remove the odours.
- Do not use mechanical devices or other means to accelerate the defrosting process.

Disposal

- When discarding the appliance, remove the door gasket while leaving the shelves and baskets in place and keep children away from the appliance.
- Dispose of all packaging materials (such as plastic bags and styrofoam) away from children. The packaging materials can cause suffocation.

Technical Safety

- Keep ventilation openings, in the appliance enclosure or in the built-in structure, clear of obstruction.
- Do not use electrical appliances inside the food storage compartments of the appliance, unless they are of the type recommended by the manufacturer.
- The refrigerant and insulation blowing gas used in the appliance require special disposal procedures. Consult with service agent or a similarly qualified person before disposing of them.

- This appliance contains a small amount of isobutane refrigerant (R600a), natural gas with high environmental compatibility, but it is also combustible. When transporting and installing the appliance, care should be taken to ensure that no parts of the refrigerating circuit are damaged.
- Refrigerant leaking out of the pipes could ignite or cause an explosion.
- If a leak is detected, avoid any naked flames or potential sources of ignition and air the room in which the appliance is standing for several minutes. In order to avoid the creation of a flammable gas air mixture if a leak in the refrigerating circuit occurs, the size of the room in which the appliance is used should correspond to the amount of refrigerant used. The room must be 1 m² in size for every 8 g of R600a refrigerant inside the appliance.
- The amount of refrigerant in your particular appliance is shown on the identification plate inside the appliance.
- Never start up an appliance showing any signs of damage. If in doubt, consult your dealer.
- This appliance is intended to be used in household and similar applications only. It should not be used for commercial, or catering purposes, or in any mobile application such as a caravan or boat.
- Do not store explosive substances such as aerosol cans with a flammable propellant in this appliance.

 CAUTION

To reduce the risk of minor injury to persons, malfunction, or damage to the product or property when using this product, follow basic precautions, including the following:

Installation

- Do not tilt the appliance to pull or push it when transporting.
- Make sure not to get a body part such as a hand or foot stuck while moving the appliance.

Operation

- Do not touch frozen food or the metal parts in the freezer compartment with wet or damp hands. It may cause frostbite.
- Do not place glass containers, bottles or cans (especially those containing carbonated drinks) in the freezer compartment, shelves or ice bin that will be exposed to temperatures below freezing.
- The tempered glass on the front side of the appliance door or the shelves can be damaged by an impact. If it is broken, do not touch it with hands, as this may result in injury.
- Do not place heavy objects on top of the door in door.
- Do not use the door in door as a chopping board and ensure it is not scratched by a sharp tool, as this may cause appliance damage.
- Do not hang from the appliance door, storage room, shelf or fridge door in door or climb up into it.
- Do not store an excessive amount of water bottles or containers for side dishes on the door baskets. The basket may break or your hand may bump into the surrounding structure, causing injury.

- Keep food organized inside the appliance.
- Prevent animals from nibbling on the power cable or water hose.
- Do not open or close the appliance door with excessive force.
- If the hinge of the appliance door is damaged or operates improperly, stop using the appliance and contact an authorized service centre.
- Supervise a child or a person with poor cognitive skills to ensure they use the appliance safely.
- Do not damage the pipes of the refrigerant circuit.
- Do not place any electronic appliance (such as heater and mobile phone) inside the appliance.
- Do not clean glass shelves or covers with warm water when they are cold. They may break if exposed to sudden temperature changes.
- Never eat frozen foods immediately after they have been taken out in the freezer compartment.
- Do not insert your hands into the mechanical part of the automatic icemaker such as the ice bin or the ice dispenser.
- Do not use a thin crystal cup or chinaware when dispensing.
- Do not remove the cover of the automatic icemaker. Touching any mechanical part of the automatic icemaker. It may result in injury.
- Make sure your hands and feet do not get stuck when opening or closing the appliance door or the door in door.
- Do not open the door of the appliance with the door in door open, or do not open the door in door while the door of the appliance is open. The door in door may be struck by the edge of the appliance and damaged.

Maintenance

- Do not insert the shelves upside down. The shelves may fall, causing injury.
- To remove frost from the appliance, contact an LG Electronics customer information centre.
- Dispose of the ice inside the ice bin in the freezer compartment during an extended power outage.
- Connect the water supply line (for plumbed models only) to a potable water source only. Otherwise, impurities in the water may cause illness.

INSTALLATION

EN

Compartments

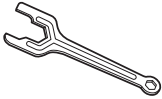
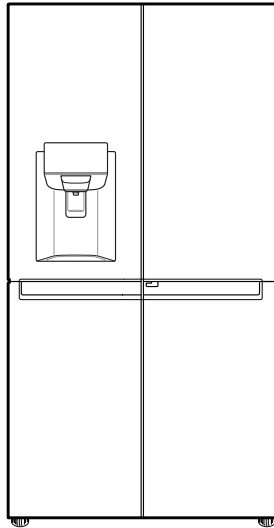

Spanner Type 1



Spanner Type 2



Owner's Manual

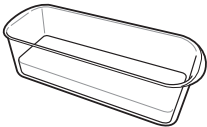

Egg Box (Optional)



C-Clip

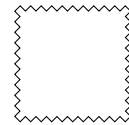

Cleaning Cloth

- The appearance or components of the appliance may differ from model to model.

Notes for Movement and Transport

- Remove all food from inside the appliance. Then, transport the appliance only after fixing fragile parts such as shelves and the door handle with tape. Failure to do so may cause appliance damage.
- Pull the power plug out, insert and fix it into the power plug hook at the rear or on top of the appliance. Failure to do so may cause damage to the power plug or floor scratch.
- When transporting the appliance, more than two people should transport the appliance carefully. Dropping the appliance, which is extremely heavy, may cause personal injury or appliance failure.
- When transporting the appliance over a long distance, keep the appliance upright. The appliance may fall over, causing malfunctions. Never transport the appliance laying down as it can cause a refrigerant circulation malfunction when it is turned back on again.

Notes for Installation

- Install the appliance on a firm and level floor.
 - If the appliance is installed on an uneven floor, it can cause vibration and noise causing the appliance to fall resulting in injury. It could also cause the doors not to close correctly and introduce moisture inside the unit during operation.
 - If the appliance front or rear is not level, adjust the front feet so that it can be corrected. Severe cases may need the floor to be packed out with strips of thin timber.
- Avoid placing the unit near heat sources, direct sunlight or moisture.
- Connect the power supply cord (or plug) to the outlet. Don't double up with other appliances on the same outlet.
- After connecting the power supply cord (or plug) to the outlet, Wait two or three hours before you put food into the appliance. If you add food before the appliance has cooled completely, your food may spoil.
- After installing the appliance, connect the power plug into a outlet socket. Before moving and discarding the appliance, disconnect the plug from the outlet socket.

Dimensions and Clearances

- Too small of a distance from adjacent items may result in the degradation of freezing capability and increased electricity costs. Allow over 50 mm of clearance from each adjacent wall when installing the appliance.

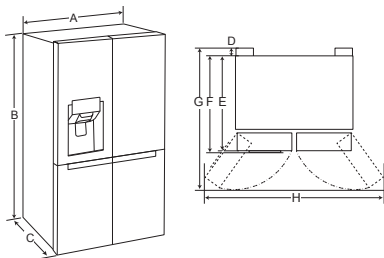

Type	Depth A	Depth B
A	912 mm	912 mm
B	1797 mm	1797 mm
C	924 mm	759 mm
D	20 mm	20 mm
E	898 mm	733 mm
F	904 mm	739 mm
G	996 mm	996 mm
H	1637 mm	1637 mm

NOTE

- You can determine what type of appliance it is by looking at the label inside the fridge compartment.

Ambient Temperature

- The appliance is designed to operate within a limited range of ambient temperatures, depending on the climate zone. Do not use the appliance at a temperature exceeding the limit.
- The internal temperatures could be affected by the location of the appliance, the ambient temperature, the frequency of door opening and so on.
- The climate class can be found on the rating label.

Climate Class	Ambient Temperature Range °C
SN (Extended Temperate)	+10 - +32
N (Temperate)	+16 - +32
ST (Subtropical)	+16 - +38
T (Tropical)	+16 - +43 / +10 - +43*

*Australia, India, Kenya

NOTE

- The appliances rated from SN to T are intended to be used at an ambient temperature between 10 °C and 43 °C.

Removing the Door

When it is necessary to move the appliance through a narrow opening, removing the doors is the recommended procedure.

⚠ WARNING

- Disconnect the power cord, house fuse or circuit breaker before installing the appliance or cleaning the exterior or vacuuming the rear lower cover. Failure to follow these instructions may result in death, fire or electric shock.
- If your entrance door is too narrow for the appliance to pass through, remove the appliance doors and pass the appliance laterally.

Removing the Left Fridge Door

The water supply line is connected to the top right part in the back of the appliance. While pressing the collet towards the the tube connector, remove the connected water tube.

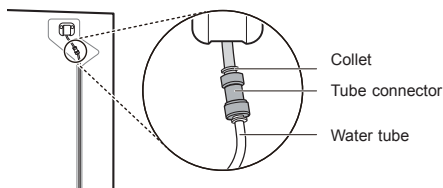

Removing the Left and Right Fridge Door

- 1 Open the door. Remove the top hinge cover screw (1) and the hinge cover (2).

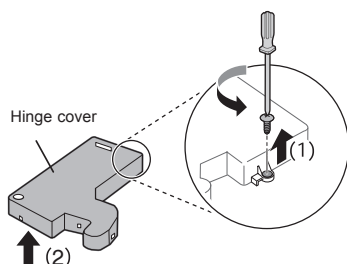

- 2 While pressing down on the hook of the wire harness connector, remove the connector by pulling it in both directions.

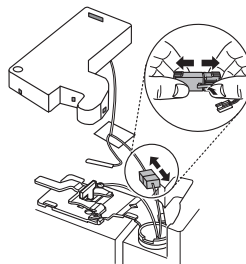

- 3 Rotate the hinge lever counterclockwise. Lift the top hinge free of the hinge lever latch.

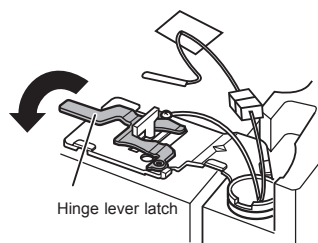

⚠ CAUTION

- When removing the upper hinge, be sure to support the door as it will fall forwards. It is recommended that two or more people carry out the door removal and refitting.
- When lifting the hinge free of the latch, be careful that the door does not fall forward.
- Place the door, inside facing up, on a non-scratching surface.

- 4 Lift the left fridge door upward (1). At this time, the door should be lifted high enough so that the water tube with the spiral spring (2) has come entirely out.

<Left fridge door>

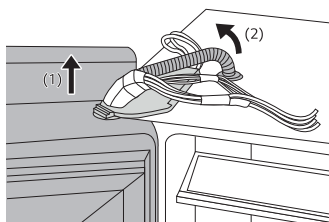

Lift the upper hinge fixed between the appliance and the appliance door and then remove it.

<Right fridge door>

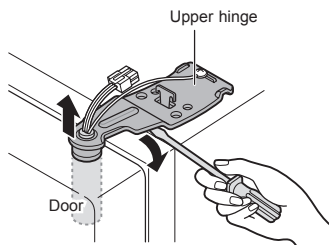

CAUTION

- Place the door on a non-scratching surface with the inner side facing up.

- 5 Lift the door off of the middle hinge pin and remove the door.

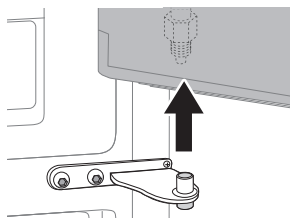

NOTE

- When moving the left fridge door, be careful not to damage the water tubes. The doors should be laid down on a blanket in a safe area once they have been removed.
- If the water tube end is damaged, it should be trimmed to ensure it does not leak when refitted.



- While pressing the collet toward the tube connector, gently insert the water tube until only one line is visible. Pull on the water tube to make sure that the tube is tightly fastened.

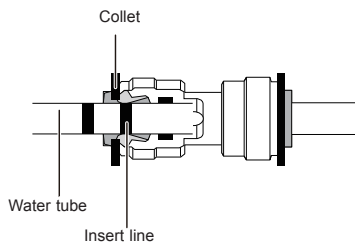

<Correct>

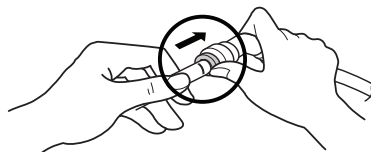

<Incorrect>

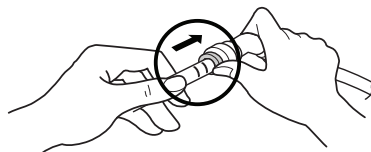

Refitting the Fridge Doors

Mount the doors in the reverse sequence of their removal once the appliance has been passed through all access doors.

Removing the Freezer Door

- 1 Remove the two hinge bolts.

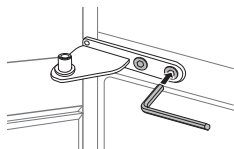

- 2 Twist the hinge to raise the pivoting end so that the door can be lifted off.

Lift the door off the lower hinge pin and remove it.

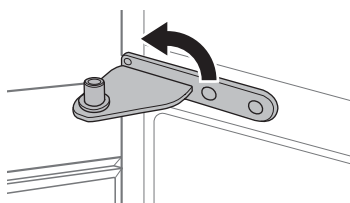

- 3 Remove the door by lifting it off the lower hinge pin.

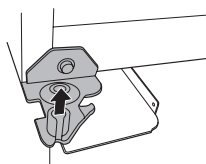

Lower Hinge

Refitting the Freezer Doors

Mount the doors in the reverse sequence of their removal once the appliance has been passed through all access doors.

Adjusting the Height of the Door

If the door is too low, lift the door up and screw on a door hinge bolt in the manner shown below using a spanner and a pair of long nose pliers.

Adjusting the Fridge Door

Left Door

Open the fridge door and use the spanner type 1 to rotate the door hinge bolt as shown below.

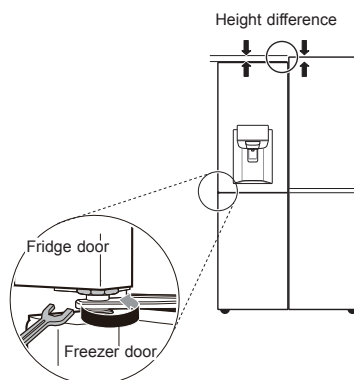

Right Door

<Type1>

If the door is too low, use the spanner type 1 to rotate the door hinge bolt as shown below.

<Type2>

If the door is too low, lift the right door up and insert use a pair of long nose pliers to insert c-clips until both doors are level.

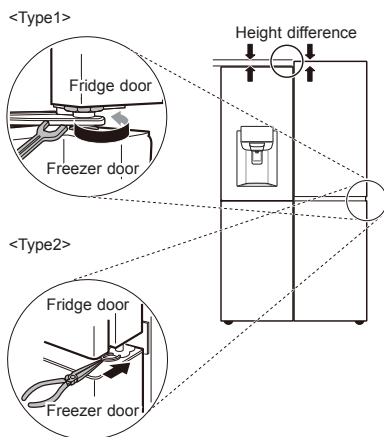

Adjusting the Freezer Door

If the door of the appliance is not level, adjust the difference in the height of appliance door using the following method.

NOTE

- Because the hinge pin may fall out, do not adjust the height of the appliance door more than 5 cm.

*Reference

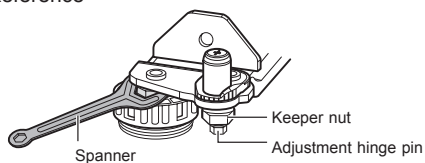

- 1 Loosen the keeper nut by rotating it counterclockwise using a 19 mm spanner.

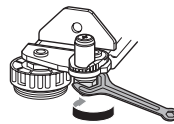

To loosen the nut

- 2 Adjust the difference in the height of the appliance door by rotating the adjustment hinge pin clockwise or counterclockwise with an 8 mm spanner.

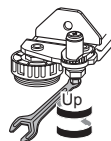

Down
Up

- 3 After adjusting the difference in the height of the appliance door, fasten the keeper nut by rotating it clockwise.

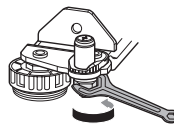

To tighten the nut

If it is impossible to adjust the height of the appliance door through the above method, level the door according to the following guide.

Adjusting a Tilted Appliance

If the door of the appliance is not level, adjust the difference in the height of appliance door using the following method.

NOTE

- Because the hinge pin may fall out, do not adjust the height of the appliance door more than 5 cm.

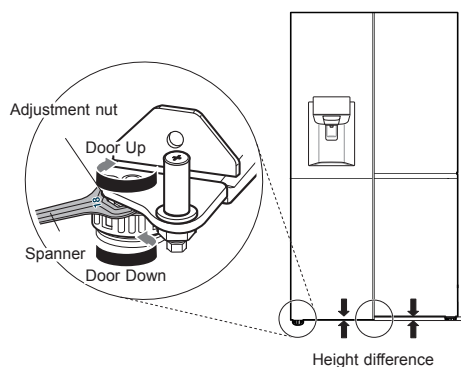

Open the door and use the supplied spanner type 2 to adjust the level of the lower side, using the nut on the adjustable round foot as per the below diagram.

Connecting the Water Line

Accessories

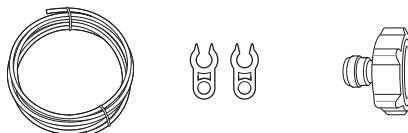

Water Tube Locking Clip Tube Connector

Water Supply Requirements

A cold water supply with water pressure between 138 kPa and 827 kPa (1.4-8.4 kgf/cm²) is required to operate the water dispenser. If the refrigerator is installed in an area with low water pressure (below 138 kPa), you can install a booster pump to compensate for the low pressure.

If a reverse osmosis water filtration system is connected to your cold water supply, the water pressure to the reverse osmosis system needs to be a minimum of 138 kPa to 827 kPa (1.4-8.4 kgf/cm²)

⚠ WARNING

- Unplug the appliance before carrying out any work on connecting the water line. Failure to do so may cause electric shock.
- Only connect the water line to a cold water supply. Failure to do so may cause the water filter to malfunction. Water hammer (water banging in the pipes) in house plumbing can cause damage to appliance parts and can lead to water leakage or flooding.
- Connecting the water line must only be installed by a qualified plumber and in accordance with local legislation and regulations governing water quality.

NOTE

- This water line installation is not covered by the appliance warranty.

Connecting to the Appliance

- 1 Unscrew the metal threaded collar nut at the back of the appliance and place it over one end of the water tube.
- 2 Firmly push the water tube onto the water inlet valve and tighten up the collar nut.

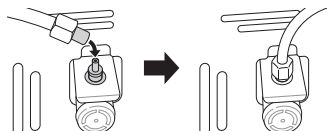

Connecting to the Water Tap

- 1 Push the water tube into the hole of the tap connector supplied in the accessories. The pipe should be held firmly whilst the connector is pushed onto the pipe.

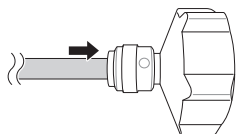

- 2 Ensure that the rubber washer is fitted inside to the inside of the tap connector before screwing it onto the tap.

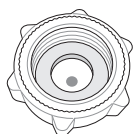

Checking the Water Connection

- 1 Turn on the water supply and switch on the appliance. Carefully check all fittings for possible leaks due to poorly fitted hoses.
- 2 Press and hold the **Water Filter** button for three seconds. That resets the Replacement Filter icon. The new water filter has been activated.
- 3 Place a cup under the water dispenser to verify that water is flowing through the appliance.
- 4 Check the connecting tube and joints for leaks once again.
- 5 The water filter should be fixed at a appropriate place where it is easy to reach for replacement purposes.

Parts and Functions

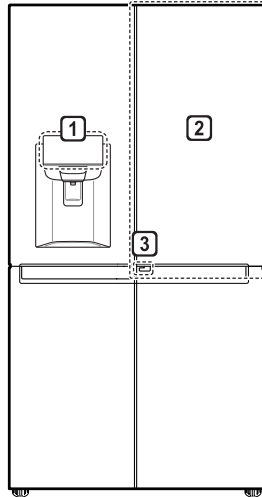

1 Control Panel

Displays the ice maker and dispenser modes the water filter status.

2 Door in Door (some models only)

The Door in Door is a double layered door system. It can be opened individually or together with the main door. You can conveniently locate and access your favourite snacks or food items.

3 Door in Door Lever (some models only)

This lever opens Door in Door.

- The appearance or components of the appliance may differ from model to model.

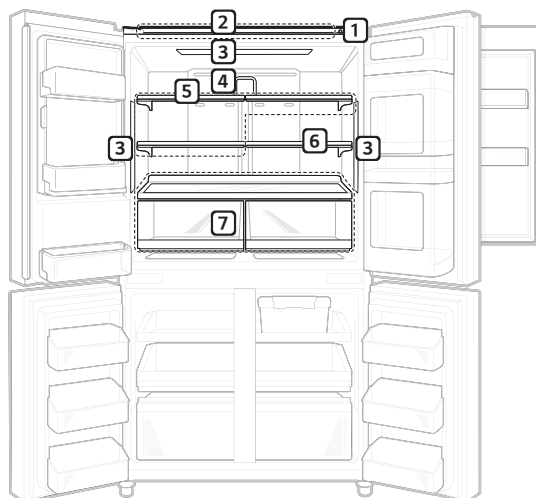

1 Smart Diagnosis Unit

Use this function when contacting LG Electronics customer information centre to help make an accurate diagnosis when the appliance operates abnormally or a failure occurs.

2 Bluetooth Sound Bar (Optional)

You can connect your smart device to a bluetooth sound bar. Please see the enclosed guide in the appliance for more details.

3 LED Lamp

The LED lamps inside the appliance light up when you open the door.

4 Pure N Fresh

This function reduces and removes odors inside the fridge compartment.

5 Fridge Shelf

This is where refrigerated foods and other items are stored.

- The shelf height can be adjusted by inserting the shelf in another groove of different height.
- Store the foods with higher moisture content at the front of the shelf.
- The actual number of shelves will differ from model to model.

6 Folding Shelf

Shelf is adjustable to meet individual storage needs.

7 Vegetable Box

This is where fruits and vegetables are stored to remain fresh for as long as possible.

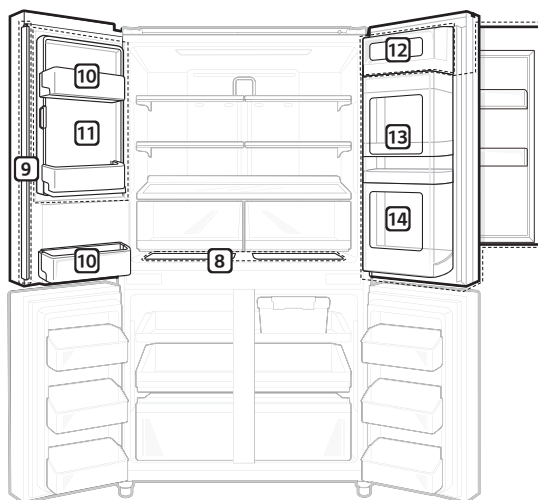

8 Extra Space (Optional)

This is where small food items such as cheese and ham can be stored.

9 Door Mullion

This prevents cold air from leaking from the appliance.

10 Fridge Door Basket

This is where small packages of refrigerated foods, drinks and sauce containers are stored.

11 Automatic Icemaker

This is where ice is automatically produced and stored.

12 Dairy Basket

This is where dairy foods such as butter and cheese can be stored.

13 Door in Door (some models only)

This is where foods which are taken out frequently such as beverages and snacks are stored.

14 Mini Table (Optional)

The mini table provides a space that is convenient to place and use small items while opening the door in door.

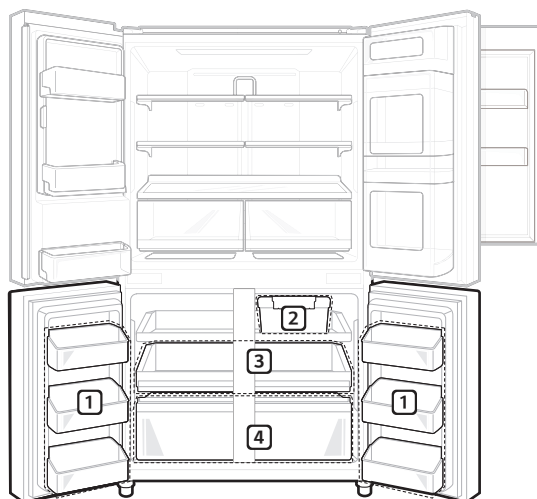
**1 Freezer Basket**

This is where small packages of frozen food can be stored.

- Do not store ice cream or food which will be stored for a long period of time within these baskets.

2 Fresh Zone (Optional)

This compartment is designed to be able to store fresh food for a long time without the odour mixing with other stored food.

- Put food in the fresh zone and keep the lid tightly closed.

3 Freezer Tray

This is where frozen foods such as the meat, fish, and ice cream, can be stored.

- The sliding trays allow easy access and convenience of use.

4 Freezer Drawer

This is for long-term storage of frozen items.

Notes for Operation

- Do not use the ice water dispenser tank for beverages other than drinking water.
- Users should keep in mind that frost can form. If the door is not closed completely, if the humidity is high during the summer, or if the freezer door is opened frequently. Condensation build up within food storage wrappers is also caused by the same conditions.
- Ensure there is sufficient space between food stored on the shelf or door basket to allow the door to close completely.
- Opening the door lets warm air enter the appliance, and may cause the internal temperature to rise and condensation to form.
- Do not open or close the appliance door excessively.
- The LED lamp is only intended for use in domestic appliances and is not suitable for household room illumination.
- If you are leaving the appliance turned off for an extended period of time, remove all food and unplug the power cord. Clean the interior, and leave the doors slightly ajar to prevent mold from growing in the appliance.

Suggestion for Energy Saving

- Ensure there is sufficient space between stored foods. This allows cold air to be circulated evenly and lowers electricity bills.
- Store hot food only after it has cooled in order to prevent dew or frost.
- When storing food in the freezer compartment, set the freezer temperature lower than the temperature indicated on the appliance.
- Do not set the temperature of the appliance lower than needed. For ice making in normal climates, the freezer temperatures should be set to -18°C or colder.
- Do not put food near the temperature sensor of the fridge compartment. Keep a distance of at least 3 cm from the sensor.
- Please note that a temperature rise after defrosting has a permissible range in the appliance specifications. If you wish to minimise the impact this may have on the food storage due to a temperature rise, seal or wrap the stored food in several layers or set the target temperature to a colder setting.
- The automatic defrosting system in the appliance ensures that the compartment remains free of ice buildup under normal operating conditions.

Storing Foods Effectively

- Store frozen food or refrigerated food inside sealed containers. It is normal for condensation or frost to form inside sealed containers due to the moisture already in the container or bag prior to it being sealed.
- Check the expiration date and label (storage instructions) before storing food in the appliance.
- Do not store food for a long period of time (more than four weeks) if it spoils easily at a low temperature.
- Place the refrigerated food or frozen food in each fridge or freezer compartment immediately after purchasing.
- Avoid refreezing any food which has been completely thawed. Freezing any food which has been completely thawed again will lower its taste and nutrition.
- Do not wrap and store vegetables with newspaper. Printing material of newspaper or other foreign substances may smear and contaminate food.
- Do not overfill the appliance. Fill less than 70 % of the space. Cold air can not circulate properly if the appliance is overfilled.
- Cool hot food before storing. If too much hot food is placed inside, the internal temperature of the appliance can increase and negatively affect other foods stored in the appliance.
- If you set an excessively low temperature for food, it may become frozen. Do not set a temperature lower than the required temperature for the food to be stored correctly.
- Always keep the appliance clean.
- If there are chill compartments in the appliance, do not store vegetables and fruits with higher moisture content in the chill compartments as they may freeze due to the lower temperature.
- In the event of a blackout, call the electricity company and ask how long it is going to last.
 - You should avoid door openings while the power is off.
 - When the power supply gets back to normal, check the condition of the food.

Max Freezing Capacity

- The Express Freeze function will allow the freezer to its maximum freezing capacity. This generally takes up to 24 hours, however, it will automatically turn off after a given time and can also be turned off manually at any given time.
- To get better air circulation, insert all inner parts like baskets, drawers, and shelves.

Maximum Storage

- To get better air circulation, insert all drawers.
- If large quantities of food are to be stored, all the freezer drawers shall be taken out of the appliance except the bottom one and the food shall be stacked directly on the freezer shelves are freezer compartment.

NOTE

- To remove the drawers, first pick the food out of drawers. Then use the handle of drawers, pull out the drawers carefully. It may cause injury.
- The shape of each drawer may be different, insert in the right position.

Control Panel

Units and Functions

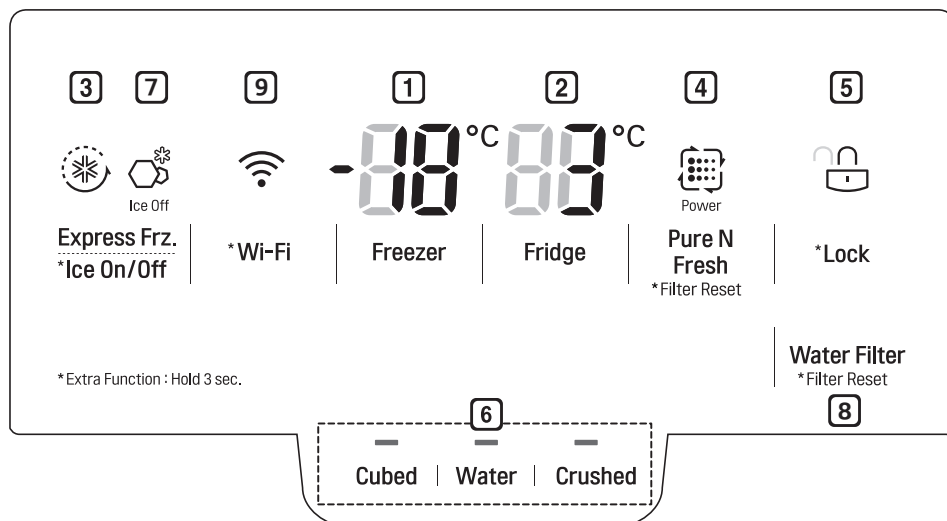

1 Freezer Temperature

- This sets the freezer target temperature.

2 Fridge Temperature

- This sets the fridge target temperature.

3 Express Freeze

- This sets Express Freeze functions.

4 Pure N Fresh

- This sets the Pure N Fresh function.
- This function reduces and removes odors inside the fridge compartment.

5 * Lock

- This locks the buttons on the control panel.

6 Water Dispenser

- This sets the function of Cubed ice, Water, Crushed ice.

7 Ice On/Off

- This sets turns the Icemaker ON or OFF.

8 Replacement Filter

- This shows the replacement period of the water filter automatically.

9 * Wi-Fi

- This sets the refrigerator to connect to your home's Wi-Fi network.

– The actual control panel may differ from model to model.

Notes for Using the Control Panel

- The control panel will turn on in any of the following cases.
 - When the power is turned on
 - When a button is pressed
 - When the appliance door (fridge compartment, freezer compartment, door in door) is opened
- The control panel will turn off automatically for energy saving in any of the following cases.
 - When one minute has passed after turning on the power
 - When no button operation is carried out for 20 seconds after a desired button is pressed
 - When 20 seconds has passed after the appliance door (fridge compartment, freezer compartment, door in door) is opened and closed
- If there is any finger or skin contact to the control panel while cleaning it, the button function may operate.

Setting the Temperature

This sets the fridge temperature or freezer temperature.

- Press the **Fridge** button or **Freezer** button to adjust the temperature.
- The initial temperature is set.
 - Fridge : 3 °C
 - Freezer : -18 °C
- The temperature can be adjusted.
 - Fridge : from 0 °C to 6 °C
 - Freezer : from -24 °C to -16 °C
- The actual inner temperature varies depending on the food status, as the indicated setting temperature is a target temperature, not actual temperature within the appliance.

NOTE

- The default temperature setting may vary depending on the appliance.
- Wait until two or three hours have passed after connecting the appliance to the outlet before storing food in the appliance.
- The appliance can automatically detect problems during the operation.
- If a problem is detected, the appliance may not operate and an error code is displayed even when any button is pressed.
- When this occurs, do not turn off the power and immediately contact the LG Electronics customer information centre. If you turn off the power, the repair technician from the LG Electronics customer information centre may have difficulty finding the problem.

Setting Express Freeze

The function can quickly freeze a large amount of ice or frozen foods.

- When you press the **Express Freeze** button, the **Express Freeze** icon lights on the control panel.
- The function is enabled and disabled in turn each time you press the button.
- The Express Freeze function automatically terminates after a specific period has passed.

Setting and Resetting Lock

This locks the buttons on the control panel.

- Press and hold the **Lock** button for 3 seconds . When the Lock function is set, all buttons are locked.
- When you press the **Lock** button for 3 seconds, the **Lock/Unlock** icon on the control panel lights. The function is enabled and disabled in turn each time you press the button.
- If you press a button other than lock when the lock is set, the button will not function.
- When you press a button other than lock when the lock is set, the **Lock/Unlock** icon on the control panel will flash 3 times.
- To change a setting, first press the **Lock** button for three seconds to disable the function.

NOTE

- The Lock function does not disable the dispenser operation.

Extra Space (Optional)

Store small food items like cheese, ham, cheese, etc.

Open and close by pushing or pulling the grips.

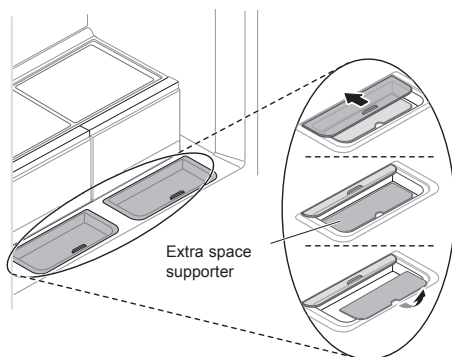

⚠ CAUTION

- Be careful when handling and storing larger eggs. They can break if the drawer is pushed in while the cover is not completely closed.
- Observe the above diagrams when removing and refitting the extra space supporter after cleaning.
- Store all moist and easily-frozen food such as tofu, sesame leaves, etc. on the front of the shelves.

Door Mullion

This door mullion prevents cold air from leaking from the appliance.

⚠ CAUTION

- The door alarm will sound every 30 seconds if the door remains open longer than one minute. Ensure that the folding mullion is folded in before closing the left-hand door.

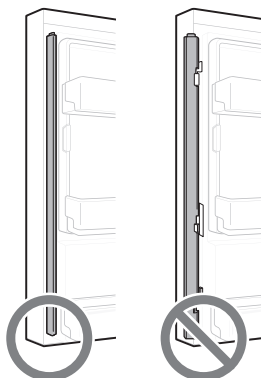

- To reduce the risk of door scratches and breaking the centre door mullion, make sure that the appliance door mullion is always folded in.

Door in Door (some models only)

Pull the lever at the bottom of the door upwards until the door in door opens.

There is plenty of storage space inside the door in door and its surrounding baskets, allowing you to store food in an organized manner.

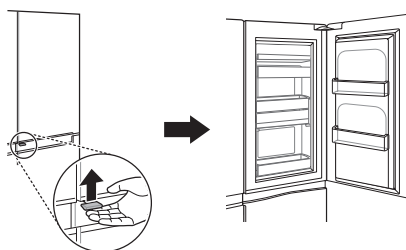

Moving Basket (Optional)

Easily move moving basket up and down as necessary.

- Remove all items from the moving basket before moving it up or down.
- Adjusting the moving basket allows taller food items to be stored more conveniently.

- 1 To raise the moving basket, hold the basket in the centre and push the basket up until it clicks into place.

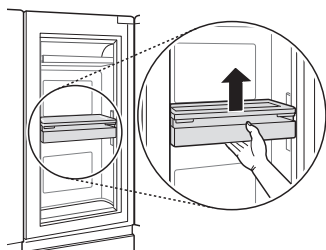

- 2 To lower moving basket, press up to release the levers at the side of the basket and lower the basket until it clicks into place.

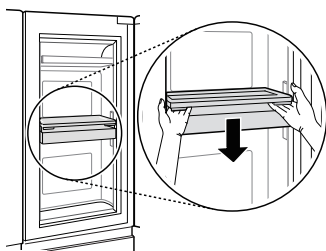

! CAUTION

- To avoid personal injury or damage to the basket or its contents, empty the moving basket bin before moving it up or down.

Mini Table (Optional)

The mini table provides a space that is convenient to place and use small items while opening the door in door.

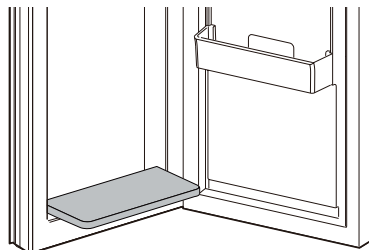

! CAUTION

- Do not apply excessive force or impact to the mini table. It may cause damage to the appliance and result in injury.
- Do not place heavy objects on top of the mini table. It may cause damage to the appliance and result in injury.
- Do not allow children to hang on the mini table. It may result in injury.
- Do not insert your fingers between the bottom of the mini table and appliance. It may result in injury.

Fresh Zone (Optional)

This compartment is designed to be able to store fresh food for a long time without the odour mixing with other stored food.

- Put food in the fresh zone and keep the lid tightly closed.

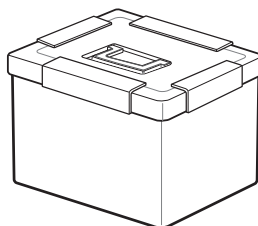

Water and Ice Dispenser

You can dispense cubed ice, water and crushed ice by pressing the respective button for the desired mode.

- When you press the Cubed, Water or Crushed button on the control panel, the lamp on the control panel will turn on and the desired mode will be set. At this time, when you press the dispenser lever, the selected function (cubed ice, water and crushed ice) will be dispensed.
- The function is enabled and disabled in turn each time you press the button on the control panel.

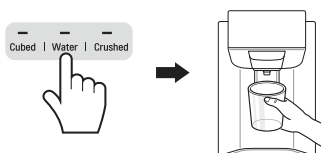

⚠ CAUTION

- Keep children away from the dispenser to prevent children playing with or damaging the controls.
- Throw away the first few batches of ice (about 20 cubes and 7 cups of water). This is also necessary if the appliance has not been used for a long time. It is normal for milky / cloudy water to be dispensed after replacing the water filter. This air in the water will eventually clear and is safe to drink during this transition.

NOTE

- If you open the freezer door while water is being dispensed, the water supply will stop and the control panel will return to the initial screen.
- If you open the fridge door while water, cubed ice or crushed ice is being dispensed, dispensing will be paused. When you close the door, the selected item for the previously set mode will continue to be dispensed.
- If the cup rim is small, water may splash out of the glass or miss it completely.
- Use a cup with a rim of over 68 mm in diameter when dispensing water, cubed ice or crushed ice.
- When the ice maker produces smaller ice cubes, or the cubes become lumped together, the amount of water supplied to the ice maker may be low due to insufficient water in the water tank. If ice is not used frequently, it may also lump together.

Automatic Icemaker

The automatic icemaker can automatically make 7 cubes at a time, 49-56 cubes in a 24 hr period if conditions are favorable. This amount may vary according to the environment (ambient temperature around the appliance, frequency of the door being opened, amount of food stored in the appliance, etc.).

- If the ice bin is completely filled with ice, ice production will stop.
- Sound of ice dropping into the ice bin is normal.
- The icemaker produces ice normally when approximately 48 hours have passed after the appliance is initially installed.
- Discard ice produced for the first time without using it.
- While the automatic icemaker is operating, do not touch it with your hands directly.
- If ice cubes are stored in the ice bin for a long period of time, they may clump together and may not be separated easily. In such a case, clean the ice bin before using it.

Turning the Automatic Icemaker On or Off

To turn the automatic icemaker On/Off, press and hold the **Ice On/Off** button on the control panel for 3 seconds.

Removing the Ice Storage Bin

- 1 Gently pull the handle to open the ice compartment.

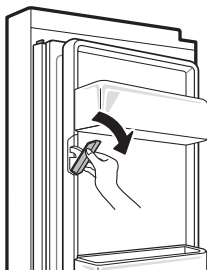

- 2 To remove the in-door ice bin, grip the front handle, lift up slightly while holding both the top and bottom parts (1), and slowly pull out the bin as shown (2).

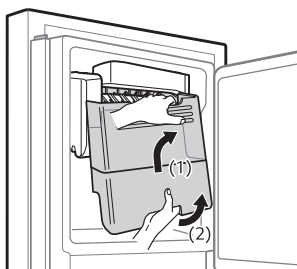

! WARNING



- Do not touch the automatic icemaker's mechanical parts with your hand or a tool. Otherwise, appliance damage or injury may occur.
- Caution should be taken, as the automatic icemaker operates continuously after the freezer door is opened when the automatic icemaker switch is set to the on position.
- Do not disassemble, repair or alter the automatic icemaker. These tasks should only be done by a service technician.

! CAUTION

- Throw away the first few batches of ice (about 20 cubes and 7 cups of water). This is also necessary if the appliance has not been used for a long time. It is normal for milky / cloudy water to be dispensed after replacing the water filter. This air in the water will eventually clear and is safe to drink during this transition.
- The first ice and water dispensed may include particles or odor from the water supply line or the water tank.
- Keep children away from the dispenser. Children may play with or damage the controls.
- The ice passage may become blocked with frost if only crushed ice is used. Remove the frost that accumulates by removing the ice bin and clearing the passage with a rubber spatula. Dispensing cubed ice periodically can also help prevent frost buildup.
- If discolored ice is dispensed, check the water tank and the water supply for a possible source. If the problem continues, contact the LG Electronics customer information centre. Do not use the ice or water until the problem is corrected.
- Dispense ice into a glass before filling it with water or other beverages. Splashing may occur if ice is dispensed into a glass that already contains liquid.
- Do not touch the ice outlet or the automatic icemaker with your hand or a tool. Otherwise, appliance damage or injury may occur.
- When refitting the ice bin, ensure that it is placed correctly. If it is tilted or unlevel, it may not continue to make ice due to sensor disruption.
- Never use a glass that is exceptionally narrow or deep. Ice may jam in the ice passage, affecting the performance of the appliance.
- Keep the glass at a proper distance from the ice outlet. A glass held too close to the outlet may prevent ice from dispensing.
- Dispose of the ice inside the ice bin in the freezer compartment if you go on vacation or if an extended power outage occurs. Water from melting ice may drop from the dispenser onto the floor.

Using the LG SmartThinQ Application

Things to check before using LG SmartThinQ

- For appliances with the  or  logo
- 1 Check the distance between the appliance and the wireless router (Wi-Fi network).
 - If the distance between the appliance and the wireless router is too far, the signal strength becomes weak. It may take a long time to register or installation may fail altogether.
 - 2 Turn off the **Mobile data** or **Cellular Data** on your smartphone.
 - For iPhones, turn data off by going to **Settings** → **Cellular** → **Cellular Data**.

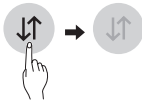

- 3 Connect your smartphone to the wireless router.



NOTE

- To verify the Wi-Fi connection, check that **Wi-Fi**  icon on the control panel is lit.
- The appliance supports 2.4 GHz Wi-Fi networks only. To check your network frequency, contact your Internet service provider or refer to your wireless router manual.
- LG SmartThinQ is not responsible for any network connection problems or any faults, malfunctions, or errors caused by network connection.

- If the appliance is having trouble connecting to the Wi-Fi network, it may be too far from the router. Purchase a Wi-Fi repeater (range extender) to improve the Wi-Fi signal strength.
- The Wi-Fi connection may not connect or may be interrupted because of the home network environment.
- The network connection may not work properly depending on the Internet service provider.
- The surrounding wireless environment can make the wireless network service run slowly.
- The appliance cannot be registered due to problems with the wireless signal transmission. Unplug the appliance and wait about a minute before trying again.
- If the firewall on your wireless router is enabled, disable the firewall or add an exception to it.
- The wireless network name (SSID) should be a combination of English letters and numbers. (Do not use special characters.)
- Smartphone user interface (UI) may vary depending on the mobile operating system (OS) and the manufacturer.
- If the security protocol of the router is set to **WEP**, you may fail to set up the network. Please change it to other security protocols (**WPA2** is recommended) and register the product again.

Installing LG SmartThinQ

Search for the LG SmartThinQ application from the Google Play Store or Apple App Store on a smart phone. Follow instructions to download and install the application.

NOTE

- If you choose the simple login to access the LG SmartThinQ application, you must go through the appliance registration process each time you change your smartphone or reinstall the application.

Wi-Fi Function

- For appliances with the  or  logo
Communicate with the appliance from a smart phone using the convenient smart features.

Firmware Update

Keep the appliance performance updated.

Smart Diagnosis™

If you use the Smart Diagnosis function, you will be provided with the useful information such as a correct way of using the appliance based on the pattern of use.

Settings

Allows you to set various options on the appliance and in the application.

NOTE

- If you change your wireless router, your Internet service provider or your password after registering the appliance, please delete it from the LG SmartThinQ **Settings** → **Edit Product** and register again.
- The application is subject to change for appliance improvement purposes without notice to users.
- Functions may vary by model.

Connecting to Wi-Fi

The **Wi-Fi** button, when used with the LG SmartThinQ application, allows the refrigerator to connect to a home Wi-Fi network. The **Wi-Fi** icon shows the status of the refrigerator's network connection. The icon illuminates when the refrigerator is connected to the Wi-Fi network.

Initial Appliance Registration

Run the LG SmartThinQ application and follow the instructions in the app to register the appliance.

Re-registering the Appliance or Registering Another User

Press and hold the **Wi-Fi** button for 3 seconds to temporarily turn it off. Run the LG SmartThinQ application and follow the instructions in the application to register the appliance.

NOTE

- To disable the Wi-Fi function, press and hold the **Wi-Fi** button for 3 seconds. Wi-Fi icon will be turned of.

RF Radiation Exposure Statement

This equipment shall be installed and used at a minimum distance of 20 cm from the human body.



Open Source Software Notice Information

To obtain the source code under GPL, LGPL, MPL, and other open source licenses, that is contained in this product, please visit <http://opensource.lge.com>.

In addition to the source code, all referred license terms, warranty disclaimers and copyright notices are available for download.

LG Electronics will also provide open source code to you on CD-ROM for a charge covering the cost of performing such distribution (such as the cost of media, shipping, and handling) upon email request to opensource@lge.com. This offer is valid for a period of three years after our last shipment of this product. This offer is valid to anyone in receipt of this information.

Smart Diagnosis™ Using a Smart Phone

- For appliances with the  or  logo
Use this function if you need an accurate diagnosis by an LG Electronics customer information centre when the appliance malfunctions or fails.

Smart Diagnosis™ can not be activated unless the appliance is connected to power. If the appliance is unable to turn on, then troubleshooting must be done without using Smart Diagnosis™.

Using Smart Diagnosis™

Smart Diagnosis™ Through the Customer Information Centre

Use this function if you need an accurate diagnosis by an LG Electronics customer information centre when the appliance malfunctions or fails. Use this function only to contact the service representative, not during normal operation.

- 1 Press the **Lock** button to activate the lock function.
 - If the lock function has been activated already, press the **Lock** button to deactivate the lock function, and then press the **Lock** button again to activate the lock function.
 - Please note that the Smart Diagnosis function will not operate until five minutes has passed since the lock function was activated.

* Lock



- 2 Open the fridge door and then hold the phone on the upper right speaker hole.
 - Position the phone so that its microphone is aligned with the speaker hole.

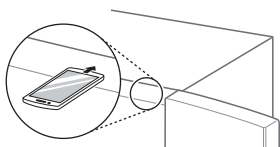

- 3 Press and hold the **Freezer** button for three seconds or longer while continuing to hold your phone to the speaker.

- 4 After the data transfer is complete, the service agent will explain the result of the Smart Diagnosis™.

NOTE

- Position the phone so that its microphone is aligned with the speaker hole.
- The Smart Diagnosis™ sound is generated after around three seconds.
- Hold the phone to the upper right speaker hole and wait while the data is transmitted.
- Do not take the phone off the speaker hole while the data is transmitted.
- The data transfer sound may be harsh to the ear while the Smart Diagnosis™ data is being transmitted, but do not take the phone off the speaker hole for accurate diagnosis until the data transfer sound has stopped.
- When the data transfer is complete, the transfer completion message is displayed and the control panel is automatically turned off and then on again after a few seconds. Afterwards the customer information centre explains the diagnosis result.
- The Smart Diagnosis™ function depends on the local call quality.
- The communication performance will improve and you can transmit a better signal if you use a land line home phone.
- If the Smart Diagnosis™ data transfer is poor due to poor call quality, you may not receive the best Smart Diagnosis™ service.

Notes for Cleaning

- When removing a shelf or drawer from inside the appliance, remove all stored foods from the shelf or drawer to prevent injury or damage to the appliance.
 - Otherwise, injury may occur due to the weight of stored foods.
- If cleaning the outside air vents of the appliance by means of vacuuming, then the power cord should be unplugged from the outlet to avoid any static discharge that can damage the electronics or cause an electric shock.
- Detach the shelves and drawers and clean them with water, and then dry them sufficiently, before replacing them.
- Regularly wipe the door gaskets with a wet soft towel.
- Door basket spills and stains should be cleaned as they can compromise storage ability of the basket and could even be damaged.
- After cleaning, check if the power cable is damaged, warm or improperly plugged.
- Keep the air vents on the exterior of the appliance clean.
 - Blocked air vents can cause fire or appliance damage.
- Waxing external painted metal surfaces helps provide rust protection. Do not wax plastic parts. Wax painted metal surfaces at least twice a year using appliance wax (or auto paste wax). Apply wax with a clean, soft cloth.
- When cleaning the inside or outside of the appliance, do not wipe it with a rough brush, toothpaste, or flammable materials. Do not use cleaning agents containing flammable substances.
 - This may cause discoloration or damage to the appliance.
 - Flammable substances: alcohol (ethanol, methanol, isopropyl alcohol, isobutyl alcohol, etc.), thinner, bleach, benzene, flammable liquid, abrasive, etc.
- For the appliance exterior, use a clean sponge or soft cloth and a mild detergent in warm water. Do not use abrasive or harsh cleaners. Dry thoroughly with a soft cloth. Do not use contaminated cloths when cleaning the stainless steel doors. Always use a dedicated cloth and wipe in the same direction as the grain. This helps reduce surface staining and tarnishing.
- Never clean the shelves or containers in the dishwasher.
 - The parts may become deformed due to the heat.
- If the appliance is equipped with an LED lamp, do not remove lamp cover and LED lamp in any attempt to repair or service it. Please, contact the LG Electronics customer information centre.

Replacing the Pure N Fresh Filter (Optional)

To maintain the performance of the Pure N Fresh filter, if a message indicating the filter replacement is displayed, replace the filter as soon as possible.

- 1 If **Replace** icon lights on the control panel, replace the Pure N Fresh filter.



- 2 Hold and remove the Pure N Fresh filter cover by rotating it counterclockwise.



- 3 Remove the filter inside the Pure N Fresh filter cover and replace it with a new filter.

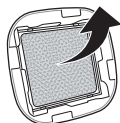

- 4 After replacing the filter, insert the Pure N Fresh filter cover by rotating it clockwise.



- 5 To reset the filter replacement period, press the **Pure N Fresh** button on the control panel for more than three seconds. The **Replace** icon on the control panel will turn off.

- 6 It will operate after replacing the filter.

NOTE

- Do not insert your finger or other foreign objects inside or its mounting. Doing so may result in injuries or malfunctions.
- If the replacement period has passed, the bacteria and odor removal performance may deteriorate.
- Please note that if you wash the filter with water, the filter performance may also deteriorate.
- Caution should be taken not to change the direction of the filter to be inserted into the filter cover.
- When setting the appliance to On or Power mode after replacing the filter, check if the LED lamp near the filter is on.
- The filter can be purchased from an LG Electronics customer information centre.

Cleaning the Shelf

Removing the Fridge Shelf

- 1 Tilt the front of the shelf up and then lift the shelf straight up.
- 2 Pull the shelf out.

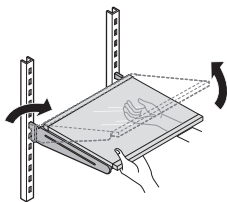

Refitting the Fridge Shelf

- 1 Tilt the front of the shelf up and guide the shelf hooks into the holes at the desired height.
- 2 Lower the front of the shelf so that the hooks into the holes.

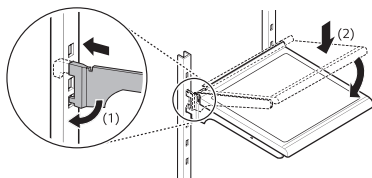

Cleaning the Vegetable Box

Removing the Vegetable Box (Type1)

- 1 Open the fridge door and take all the shelves out from the fridge compartment.

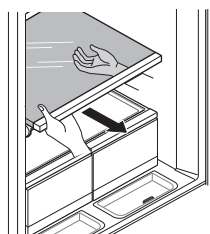

- 2 Lift the vegetable box with both hands and make space in the back by pulling it toward you.

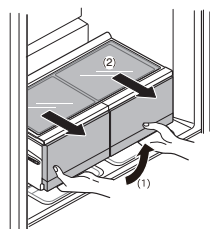

- 3 Grab the back side with one hand to lift the vegetable box, and at this time, take it out tilted at an angle.

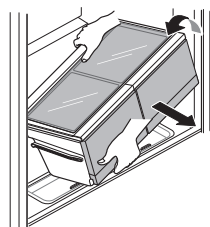

Refitting the Vegetable Box

Mount them in the reverse order of the removal process.

Removing the Vegetable Drawer (Type2)

- 1 Open the doors and remove the contents of the door in door cases and baskets. Remove the door in door case from the appliance.

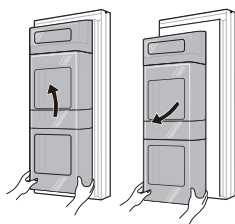

- 2 Remove the contents of the drawer. Hold the handle of the vegetable drawer and gently pull it out completely until it stops.

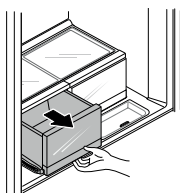

- 3 Lift the vegetable drawer up and remove it by pulling it out.

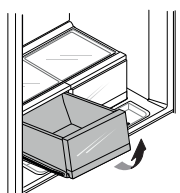

- 4 Tilt the cover slightly and support it with both hands while pulling it out.

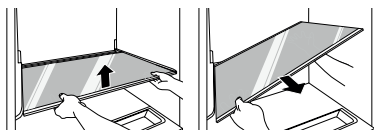

Refitting the Vegetable Drawer

Insert the bottom of the vegetable drawer into its original position and gently push it back in while lowering it.

Cleaning the Fridge/Freezer Basket

Removing the Fridge/Freezer Basket

To remove the basket, hold the basket with both hands and slightly lift up the front part to pull it out.

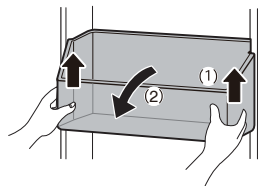

Refitting the Fridge/Freezer Basket

Mount them in the reverse order of the removal process.

Cleaning the Door in Door

Removing the Case from the Door in Door

- 1 Lift the case from door in door up and take it out with both hands.

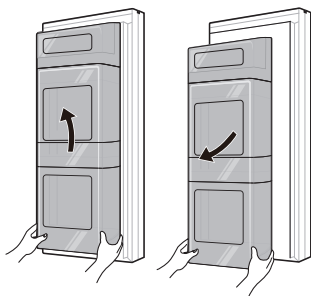

- 2 Lift and remove the bottom of the dairy basket from the whole case.



- 3 Move the moving basket to the top position.

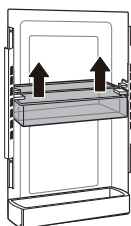

- 4 Lift and remove the moving basket from the case after remove the screws from each of the side rails.

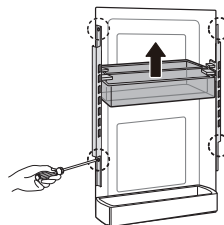

Refitting the Case from the Door in Door

Mount them in the reverse order of the removal process.

Removing the Fridge Basket from the Door in Door

Hold both ends of the basket and lift up the front part of the basket.

- Assemble in the same method as disassembly.

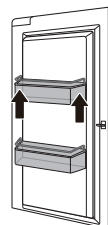

Refitting the Fridge Basket from the Door in Door

Mount them in the reverse order of the removal process.

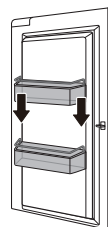

Cleaning the Mini Table

Removing the Mini Table

- 1 Open the door in door.

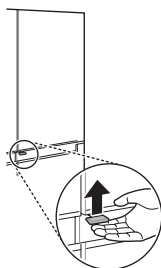

- 2 Push out and gently remove the rubber cover (2) on the left bottom side of the mini table with a small flat screw driver after the mini table has been folded up (1) in a vertical position.

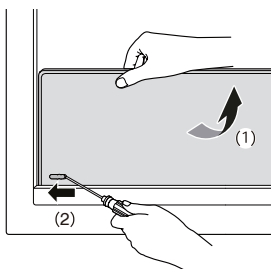

- 3 Insert a small flat screw driver into the hole of the movable pin. Slide the pin to the right and remove the mini table.

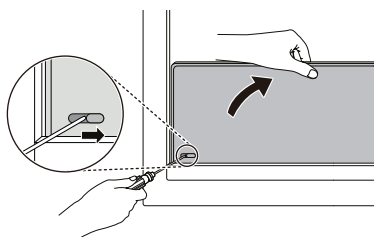

Refitting the Mini Table

- 1 Open the door in door. Insert the fixed pin of the mini table into the right side pin hole of the door in door frame.

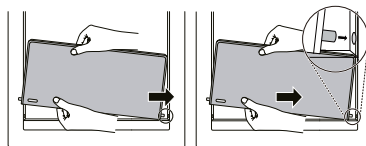

- 2 Insert the small flat screw driver into the hole of the movable pin. Push the pin to the right and refit the mini table.

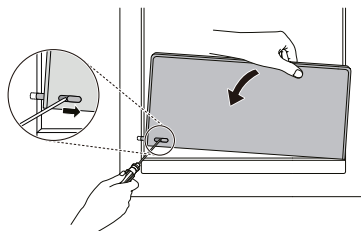

- 3 Insert the rubber cover into the hole of the mini table.

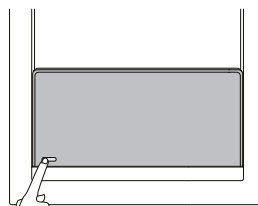

NOTE

- Make sure that it is refit securely and check that the pins are fully in the holes of the door in door frame.

Cleaning the Freezer Tray/Drawer

Removing the Freezer Tray/Drawer

- 1 Open both freezer doors completely. Pull out the freezer trays and drawers to full extension and remove all of the contents.

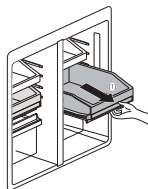

- 2 With the trays and drawers fully extended, lift up the front and pull the trays and drawers out to remove them.

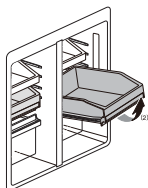

⚠ CAUTION

- The trays and drawers are heavy. Always use two hands when removing or assembling the trays and drawers to avoid product damage or personal injury.
- Always open the freezer doors completely before removing or assembling the trays and drawers.

Refitting the Freezer Tray/Drawer

Mount them in the reverse order of the removal process.

Cleaning the Water Dispenser

Cleaning the Dispenser Tray

The dispenser tray may become wet easily due to spilled ice or water. Wipe the entire area with a damp cloth.



Cleaning the Water and Ice Outlet

Wipe the water or ice outlet frequently with a clean cloth as it may get dirty easily. Please note that lint from a cloth may adhere to the outlet.

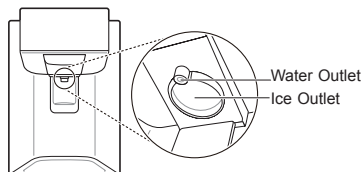

Replacing the Water Filter

Replace the disposable water filter when indicated on the **Replacement Filter** icon or at least every 6 months.

To give you preparation time to get a new filter, the light will come on just before the capacity of the current filter runs out. Changing the filter on time provides you with fresh and clean water from the appliance.

- 1 Unplug the appliance.
- 2 Turn off the water supply to the appliance.
- 3 Remove the disposable water filter.

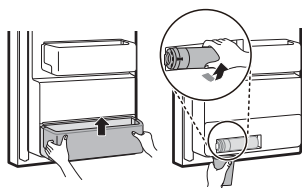

- 4 Replace with a new water filter. Insert the new filter into the filter head and rotate it clockwise until the arrow on the new filter lines up with the arrow on the filter head. Swing the filter back into the compartment.

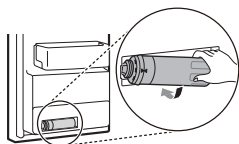

- 5 Turn on the water supply and switch on the appliance. Check the filter for any leaks.
- 6 Press and hold the **Water Filter** button for three seconds. That resets the Replacement Filter icon. The new water filter has been activated.

Symptoms	Reason	Solution
There is no refrigeration or freezing.	Is there a power interruption?	<ul style="list-style-type: none"> • Check the power of other appliances.
	If the power plug unplugged from the outlet?	<ul style="list-style-type: none"> • Plug the power plug in the outlet properly.
There is poor refrigeration or freezing.	Is the fridge or freezer temperature set to its warmest setting?	<ul style="list-style-type: none"> • Set the fridge or freezer temperature to Mid setting or colder.
	Is the appliance in direct sunlight, or is it near a heat generating object such as cooking oven or heater?	<ul style="list-style-type: none"> • Check the installation area and reinstall it away from heat generating objects.
	Did you store hot food without cooling it first?	<ul style="list-style-type: none"> • Cool the hot food first before putting it in the fridge or freezer compartment.
	Did you put in too much food?	<ul style="list-style-type: none"> • Maintain an appropriate space between food.
	Are the appliance doors completely closed?	<ul style="list-style-type: none"> • Completely close the door and make sure that stored food is not obstructing in the door.
	Is there enough space around the appliance?	<ul style="list-style-type: none"> • Adjust the installation position to make enough space around the appliance.
The appliance contains a bad smell.	Is the fridge or freezer temperature set to 'Warm'?	<ul style="list-style-type: none"> • Set the fridge or freezer temperature to Mid setting or colder.
	Did you put in food with a strong smell?	<ul style="list-style-type: none"> • Store foods with strong smells in a sealed containers.
	Vegetables or fruit may have spoiled in the drawer?	<ul style="list-style-type: none"> • Throw away rotten vegetables and clean the vegetable drawer. Do not store vegetables too long in the vegetable drawer.
The inside lamp in the appliance does not turn on.	Does the inside lamp in the appliance turn off?	<ul style="list-style-type: none"> • It is not possible for customers to replace the inside lamp in the appliance as they are not serviceable. If the inside lamp does not turn on, please contact the LG Electronics customer information centre.

Symptoms	Reason	Solution
The appliance door is not closed tightly.	Is the appliance leaning forward?	<ul style="list-style-type: none"> Adjust the front feet to raise the front side slightly.
	Were the shelves properly assembled?	<ul style="list-style-type: none"> Refit the shelves if needed.
	Did you close the door with excessive force?	<ul style="list-style-type: none"> If you apply too much force or speed when closing the door, it may remain briefly open before closing. Make sure that you do not slam the door closed. Close without force.
It is difficult to open the appliance door.	Did you open the door right after you closed it?	<ul style="list-style-type: none"> If you try to open the appliance door within one minute after you closed it, you may have difficulties because of the pressure inside the appliance. Try to open the appliance door again in a few minutes so that the internal pressure stabilizes.
Door mullion does not fold in and out properly.	Are front leveling legs extended, appliance level, and doors aligned?	<ul style="list-style-type: none"> Once the door baskets are filled, the doors may become misaligned, preventing the door mullion or the Auto Open Door function from working properly. Extend both front leveling legs fully so they are in firm contact with the floor. Follow the instruction in the Door Alignment section to raise the left appliance door until the door mullion is once again working properly. Adjust the right appliance door so it aligns with the left appliance door.

Symptoms	Reason	Solution
There is condensation inside the appliance or on the bottom of the vegetable drawer cover.	Did you store hot food without cooling it first?	<ul style="list-style-type: none"> • Cool the hot food first before putting it in the fridge or freezer compartment.
	Did you leave the appliance door open?	<ul style="list-style-type: none"> • Although the condensation will disappear soon after you close the appliance door, you can wipe it with a dry cloth.
	Do you open and close the appliance door too frequently?	<ul style="list-style-type: none"> • Condensation can form due to the temperature difference from the outside. Wipe out the dampness with a dry cloth.
	Did you put warm or moist food inside without sealing it in a container?	<ul style="list-style-type: none"> • Store food in a covered or sealed container.
Frost has formed in the freezer compartment.	Doors may not be closed properly?	<ul style="list-style-type: none"> • Check if the food item inside the appliance is blocking the door and make sure that the door is tightly closed.
	Did you store hot food without cooling it first?	<ul style="list-style-type: none"> • Cool the hot food first before putting it in the fridge or freezer compartment.
	Is the air entry or exit of the freezer compartment blocked?	<ul style="list-style-type: none"> • Make sure that air entry or exit is not blocked so that the air can circulate inside.
	Is the freezer compartment overfilled?	<ul style="list-style-type: none"> • Maintain an appropriate space between items.

Symptoms	Reason	Solution
Frost or condensation has formed inside or outside the appliance.	Did you open and close the appliance door frequently or is the appliance door improperly closed?	<ul style="list-style-type: none"> Frost or condensation can form if the outside air penetrates inside the appliance.
	Is the installation environment humid?	<ul style="list-style-type: none"> Condensation can appear on the exterior of the appliance if the installation area is too humid or on a humid day such as a rainy day. Wipe off any moisture with a dry cloth.
The appliance is noisy and generates abnormal sounds.	Is the appliance installed on a weak floor or improperly leveled?	<ul style="list-style-type: none"> Install the appliance on a firm and level floor.
	Does the rear of the appliance touch the wall?	<ul style="list-style-type: none"> Adjust the installation position to allow enough clearance around the appliance.
	Are objects scattered behind the appliance?	<ul style="list-style-type: none"> Remove the scattered objects from behind the appliance.
	Is there an object on top of the appliance?	<ul style="list-style-type: none"> Remove the object on top of the appliance.
The side or front of the appliance is warm.	There are anti condensation pipes fitted to these areas of the appliance to reduce condensation forming from around the door area.	<ul style="list-style-type: none"> The heat releasing pipe to prevent condensation is installed on the front and side of the appliance. You may feel it particularly hot right after the appliance is installed or during the summer. You can be assured that this is not a problem and is quite normal.
There is water inside or outside of the appliance.	Is there water leakage around the appliance?	<ul style="list-style-type: none"> Check if the water has leaked from a sink or another place.
	Is there water on the bottom of the appliance?	<ul style="list-style-type: none"> Check if the water is from the thawed frozen food or a broken or dropped container.

Symptoms	Reason	Solution
The automatic icemaker does not produce ice or produces a small amount of ice.	Did you install the appliance recently?	<ul style="list-style-type: none"> The ice maker produces ice normally when approximately 48 hours have passed after the appliance is installed.
	Did you connect the water supply pipe to the appliance and open the supply valve?	<ul style="list-style-type: none"> Connect the water supply pipe to the appliance and open the supply valve completely.
	Is the water supply hose bent?	<ul style="list-style-type: none"> If the water supply hose is bent, the water flow could be compromised.
	Have you dispensed a large amount of ice recently?	<ul style="list-style-type: none"> It takes approximately 24 hours to produce more ice in the automatic icemaker. Please wait.
	Did you set the ice maker switch or the automatic icemaker button on the control panel to ON?	<ul style="list-style-type: none"> Press I on the automatic icemaker switch or set ON for the automatic icemaker button on the control panel. (For more details on how to use, visit LG electronics website or use your smart device.)
	Is the temperature of the freezer compartment set too high?	<ul style="list-style-type: none"> If the set temperature is too warm, ice will be produced slowly or not at all. Set the Freezer temperature to -18 °C for normal operation of the automatic icemaker.
	Have you been opening the appliance door frequently?	<ul style="list-style-type: none"> If you open the appliance door frequently, cold air will escape, lowering the speed of ice production. Do not open and close the appliance door frequently.
	Is the appliance door completely closed?	<ul style="list-style-type: none"> If the appliance door is not completely closed, the temperature of the freezer compartment will increase, slowing down the ice production speed. Close the appliance door completely.
Ice is not dispensed.	Is there ice in the ice bin?	<ul style="list-style-type: none"> Check whether there is ice in the ice bin.
	Is the ice clumped in the ice bin?	<ul style="list-style-type: none"> Separate the ice bin and shake it. Discard the remaining clumped ice after shaking the ice bin.

Symptoms	Reason	Solution
Ice is not dispensed.	Unable to hear the sound of ice coming out?	<ul style="list-style-type: none"> In the control panel, select the modes for cubed ice and crushed ice alternately to dispense the ice.
	Is the ice path blocked? (You can check the ice passage by separating the ice bin.)	<ul style="list-style-type: none"> Ice may not be dispensed properly if the ice passage is blocked. Check the ice and clean the ice path regularly.
Water does not come out.	The supply valve may be turned off? (For Plumbed models Only)	<ul style="list-style-type: none"> Open the water supply valve.
	The water dispenser tank may be empty? (Non plumbed models only)	<ul style="list-style-type: none"> Fill the water dispenser tank.
	Is the water supply valve closed? (For Plumbed models Only)	<ul style="list-style-type: none"> Open the water supply valve.
	Are you using unfiltered water?	<ul style="list-style-type: none"> Unfiltered water can contain a large amount of various heavy metals or foreign substances, so the filter may be clogged in the early stage regardless of the life of the filter.
Water tastes strange.	Is the taste of water different when comparing it with the taste of water from the previous water purifier?	<ul style="list-style-type: none"> Has the purified water or cold water not been used for an extended period of time?
	Has it been a long time since you installed and replaced the filter?	<ul style="list-style-type: none"> If an expired filter is used, the purification performance may decline. It is recommended to replace the filter according to the filter replacement period.
	Have you flushed out the filter properly in the initial stage after installing it?	<ul style="list-style-type: none"> When you install or replace the filter for the first time, you need to remove air and activated carbon residue from inside the filter. Use the appliance after dispensing and discharging approximately 5 litres of purified water from the dispenser by pressing the water dispensing lever. (Activated carbon is harmless to humans.)
	Has the purified water or cold water not been used for an extended period of time?	<ul style="list-style-type: none"> The taste of old water may change due to bacterial growth. Use the product after dispensing and discharging approximately 5 litres (approximately three minutes) from the water dispenser.

Symptoms	Reason	Solution
Clicking noises	The defrost control will click when the automatic defrost cycle begins and ends. The thermostat control (or appliance control on some models) will also click when cycling on and off.	<ul style="list-style-type: none"> • Normal Operation
Rattling noises	Rattling noises may come from the flow of appliance, the water line on the back of the unit (for plumbed models only), or items stored on top of or around the appliance.	<ul style="list-style-type: none"> • Normal Operation
	Appliance is not resting evenly on the floor.	<ul style="list-style-type: none"> • Floor is weak or uneven or leveling legs need to be adjusted. See the Door Alignment section.
	Appliance with linear compressor was moved while operating.	<ul style="list-style-type: none"> • Normal operation. If the compressor does not stop rattling after three minutes, turn the power to the appliance off and then on again.
Whooshing noises	Evaporator fan motor is circulating air through the fridge and freezer compartments.	<ul style="list-style-type: none"> • Normal Operation
	Air is being forced over the condenser by the condenser fan.	<ul style="list-style-type: none"> • Normal Operation
Gurgling noises	Appliance flowing through the cooling system	<ul style="list-style-type: none"> • Normal Operation
Popping noises	Contraction and expansion of the inside walls due to changes in temperature.	<ul style="list-style-type: none"> • Normal Operation
Vibrating	If the side or back of the appliance is touching a cabinet or wall, some of the normal vibrations may make an audible sound.	<ul style="list-style-type: none"> • To eliminate the noise, make sure that the sides and back do not make any contact with any wall or cabinet.

Symptoms	Reason	Solution
<p>Your home appliance and smartphone is not connected to the Wi-Fi network.</p>	<p>The password for the Wi-Fi that you are trying to connect to is incorrect.</p>	<ul style="list-style-type: none"> Find the Wi-Fi network connected to your smartphone and remove it, then register your appliance on LG SmartThinQ.
	<p>Mobile data for your smartphone is turned on.</p>	<ul style="list-style-type: none"> Turn off the Mobile data of your smartphone and register the appliance using the Wi-Fi network.
	<p>The wireless network name (SSID) is set incorrectly.</p>	<ul style="list-style-type: none"> The wireless network name (SSID) should be a combination of English letters and numbers. (Do not use special characters.)
	<p>The router frequency is not 2.4 GHz.</p>	<ul style="list-style-type: none"> Only a 2.4 GHz router frequency is supported. Set the wireless router to 2.4 GHz and connect the appliance to the wireless router. To check the router frequency, check with your Internet service provider or the router manufacturer.
	<p>The distance between the appliance and the router is too far.</p>	<ul style="list-style-type: none"> If the distance between the appliance and the router is too far, the signal may be weak and the connection may not be configured correctly. Move the location of the router so that it is closer to the appliance.

Memo

Memo

Memo

