

Operating and installation instructions

Gourmet warming drawer



To prevent the risk of accidents or damage to the appliance, it is **essential** to read these instructions before it is installed and used for the first time.

Contents

Warning and Safety instructions	4
Caring for the environment	11
Overview	12
ESW 7010, ESW 7110.....	12
ESW 7020, ESW 7030, ESW 7120.....	13
Controls and display	14
Accessories supplied	15
Before using for the first time	16
Cleaning the drawer for the first time.....	16
Heating up the drawer for the first time	16
Miele@home.....	17
Operation	20
Operating principles	20
Using MobileStart.....	21
Functions.....	21
Duration.....	21
Temperature settings.....	22
Keeping food warm	23
Warming crockery	26
Heating-up times.....	26
Capacity	26
ESW 7010, ESW 7110.....	27
ESW 7020, ESW 7030, ESW 7120.....	28
Low temperature cooking	29
Other uses	34
Networking with Miele built-in appliances	35
Sabbath mode	36
Cleaning and care	37
Problem solving guide	39
Optional accessories	41
Safety instructions for installation	42
Installation notes	43

Installation dimensions ESW 7010, ESW 7110	44
Combination appliance with a height of 45 cm.....	44
Combination appliance with a height of 60 cm.....	45
Side view	46
Connections and ventilation.....	47
Installation dimensions ESW 7020, ESW 7120	48
Combination appliance with a height of 45 cm.....	48
Combination appliance with a height of 60 cm.....	49
Side view	50
Connections and ventilation.....	51
Installation dimensions ESW 7030	52
Combination appliance with a height of 45 cm.....	52
Combination appliance with a height of 60 cm.....	53
Side view	54
Connections and ventilation.....	55
Installation	56
Electrical connection	57
Service	59
Contact in case of fault	59
Data plate	59
Warranty	59

Warning and Safety instructions

Please note that the Gourmet warming drawer is referred to in these operating instructions as the drawer.

This drawer complies with all relevant safety requirements. Inappropriate use can, however, lead to personal injury and damage to property.

To avoid the risk of accidents or damage to the appliance, please read these instructions carefully before installation and using it for the first time. They contain important notes on installation, safety, use and maintenance.

Miele cannot be held liable for damage caused by non-compliance with these Warning and Safety instructions.

Keep these instructions in a safe place and ensure that new users are familiar with the content. Pass them on to any future owner.

Correct application

- ▶ This drawer is designed for domestic use and for use in similar environments by guests in hotel or motel rooms, bed & breakfasts and other typical living quarters. This does not include common/shared facilities or commercial facilities within hotels, motels or bed & breakfasts.
- ▶ This drawer is not suitable for outdoor use.
- ▶ The warming drawer must only be used as described in these instructions. Any other usage is not supported by the manufacturer and could be dangerous.
- ▶ This appliance is not intended for use by persons (including children) with reduced physical, sensory or mental capabilities, or lack of experience and knowledge, unless they have been given supervision or instruction concerning its use by a person responsible for their safety, and are able to recognise the dangers of misuse.

Warning and Safety instructions

Safety with children

- ▶ Young children must not be allowed to use this appliance.
- ▶ Older children may use the appliance without supervision if its operation has been clearly explained to them and they are able to use it safely. Children must be able to recognise and understand the potential risks of improper use.
- ▶ Cleaning may only be carried out by older children under the supervision of an adult.
- ▶ Please supervise children in the vicinity of the drawer, and do not let them play with it.
- ▶ The drawer gets hot when in use and remains hot for quite a while after being switched off. Keep children well away from the drawer until it has cooled sufficiently so that there is no longer any danger of burning.
- ▶ Danger of suffocation! Whilst playing, children may become entangled in packaging material (such as plastic wrapping) or pull it over their head with the risk of suffocation. Keep packaging material away from children.

Technical safety

- ▶ Unauthorised installation, maintenance and repairs can cause considerable danger for the user. Installation, maintenance and repairs must only be carried out by a Miele authorised technician.
- ▶ A damaged drawer can be dangerous. Always check for visible signs of damage. Never use a damaged appliance.
- ▶ Reliable and safe operation of the drawer can only be assured if it has been connected to the mains electrical supply.
- ▶ The electrical safety of this appliance can only be guaranteed when continuity is complete between it and an effective earthing system. It is most important that this basic safety requirement is present and tested regularly and, where there is any doubt, the household wiring system should be inspected by a qualified electrician.
- ▶ The connection data (voltage and frequency) on the data plate of the drawer must match the mains electricity supply in order to avoid the risk of damage to the drawer.
Compare this data before connecting the appliance. If in any doubt, consult a qualified electrician.
- ▶ Do not connect the drawer to the mains electrical supply by a multi-socket adapter or extension lead. These are a fire hazard and do not guarantee the required safety of the appliance.
- ▶ For safety reasons, this drawer may only be used when it has been built in.
- ▶ This appliance must not be installed and operated in mobile installations (e.g. on a ship).
- ▶ Never open the casing of the drawer.
Touching or tampering with electrical connections or components and mechanical parts is highly dangerous to the user and can cause operational faults.

Warning and Safety instructions

- ▶ The manufacturer's warranty will be invalidated if the appliance is not repaired by a Miele approved service technician.
- ▶ Faulty components must only be replaced by genuine Miele spare parts. The manufacturer can only guarantee the safety of the appliance when Miele replacement parts are used.
- ▶ If the plug has been removed or the connection cable is not supplied with a plug, the drawer must be connected to the mains supply by a suitably qualified electrician.
- ▶ If the mains connection cable is damaged, it must be replaced with a special connection cable of type H 05 VV-F (rubber insulated), available from Miele, by a suitably qualified and competent electrician in order to avoid a hazard (see “Electrical connection”).
- ▶ During installation, maintenance and repair work, the drawer must be disconnected from the mains electricity supply. It is only completely isolated from the electricity supply when:
 - the mains circuit breaker is switched off, or
 - it is switched off at the wall socket and the plug is withdrawn from the socket. Do not pull the mains connection cable but the mains plug to disconnect your appliance from the mains electricity supply.
- ▶ If the drawer is installed behind a furniture panel (e.g. a door), ensure that the door is never closed whilst the drawer is in use. Heat and moisture can build up behind a closed furniture panel and cause subsequent damage to the drawer, the housing unit and the floor. Do not close the door until the drawer has cooled down completely.

Warning and Safety instructions

Correct use

- ▶ You could burn yourself on the hot drawer or hot dishes. Protect your hands with heat-resistant pot holders or oven gloves when handling hot items. Do not let them get wet or damp. Heat transfers through damp and wet material more quickly with the risk of scalding or burning yourself.
- ▶ Fire hazard! Do not store any plastic containers or combustible objects in the drawer. They can melt or catch fire when the appliance is switched on.
- ▶ Due to the high temperatures radiated, objects left near the warming drawer when it is switched on could catch fire. Do not use the drawer to heat up the room.
- ▶ Never replace the anti-slip mat supplied with the appliance with paper kitchen towel or similar.
- ▶ The telescopic runners can support a maximum load of 25 kg. Overloading or leaning or sitting on the drawer will damage the telescopic runners.
- ▶ The underside of the drawer gets hot when it is in use. Be careful not to touch it when the drawer is open.
- ▶ The anti-slip mat is heat-resistant up to 200 °C. It is possible for the bottom of pots and pans to exceed this temperature, especially after they have been used to sear food. Allow pots and pans to cool down for a minute or two before placing them in the drawer.
- ▶ Items made of plastic or aluminium foil will melt at high temperatures. When keeping food warm, use only heat-resistant containers made of porcelain, glass, etc.
- ▶ If liquids get into the appliance through the vents, it can cause a short circuit. Take care when opening and closing the loaded drawer so that liquids do not spill over.

Warning and Safety instructions

- ▶ The  “Keeping food warm” function is designed to keep hot food warm and not to warm up cold food. Ensure food is sufficiently hot when placed inside the drawer.
- ▶ Bacteria can develop in certain foods if the temperature is too low. Make sure that you set a high enough temperature to keep food warm.

Cleaning and care

- ▶ Danger of electric shock! The steam from a steam cleaning appliance could reach electrical components and cause a short circuit. Never use a steam cleaner for cleaning.

Disposal of the packing material

The transport and protective packaging has been selected from materials which are environmentally friendly for disposal, and can normally be recycled.

Recycling the packaging reduces the use of raw materials in the manufacturing process and also reduces the amount of waste in landfill sites. Ensure that any plastic wrappings, bags etc. are disposed of safely and kept out of the reach of babies and young children. Danger of suffocation.

Disposing of your old appliance

Electrical and electronic appliances often contain valuable materials. They also contain specific materials, compounds and components, which were essential for their correct function and safety. These could be hazardous to human health and to the environment if disposed of with your domestic waste or if handled incorrectly. Please do not, therefore, dispose of your old appliance with your household waste.



Please dispose of it at your local community waste collection / recycling centre for electrical and electronic appliances. You are also responsible for deleting any personal data that may be stored on the appliance prior to disposal. Please ensure that your old appliance poses no risk to children while being stored prior to disposal.

Overview

ESW 7010, ESW 7110

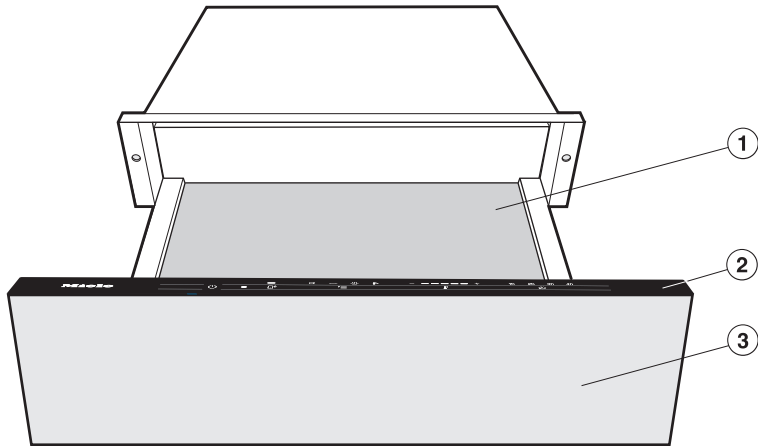

- ① Anti-slip mat
 - ② Controls and indicators
 - ③ Drawer front with Push2open mechanism
- The drawer can be opened and closed by pressing lightly on the drawer front.

ESW 7020, ESW 7030, ESW 7120

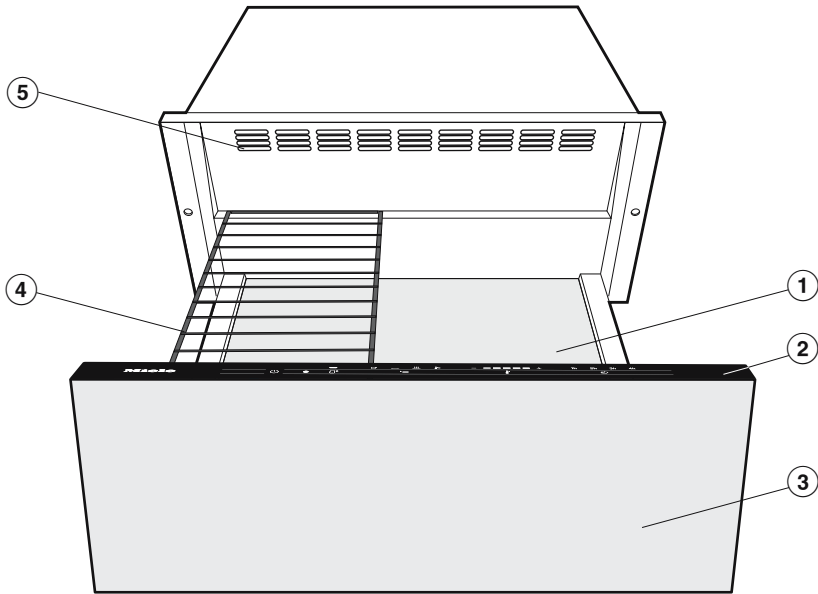

- ① Anti-slip mat
- ② Controls and indicators
- ③ Drawer front with Push2open mechanism
The drawer can be opened and closed by pressing lightly on the drawer front.
- ④ Rack
- ⑤ Air vents

Overview

Controls and display

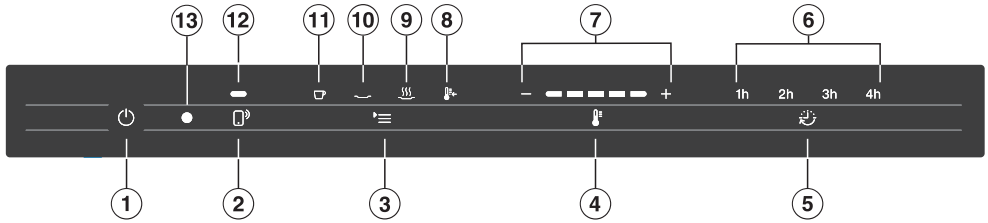

Sensor controls

- ① On/Off sensor
- ② MobileStart
- ③ Selecting the operating mode
- ④ Setting the temperature
- ⑤ Setting the duration

Display/indicator lights

- ⑥ Duration
 - 1h = 1 hour
 - 2h = 2 hours
 - 3h = 3 hours
 - 4h = 4 hours
- ⑦ Temperature display with segment bars
- ⑧ Low temperature cooking
- ⑨ Keeping food warm
- ⑩ Warming plates/dishes
- ⑪ Warming cups/glasses
- ⑫ MobileStart activated
- ⑬ Optical interface
(for Miele service technicians only)

Accessories supplied

The accessories supplied with your appliance, as well as a range of optional ones, are available to order from Miele (see “Optional accessories”).

Rack

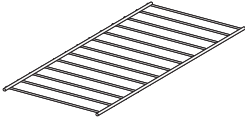

For increasing the loading area (ESW 7020, ESW 7030, ESW 7120).

Anti-slip mat

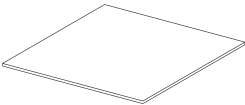

For keeping dishes secure.

“Low temperature cooking” the cookbook

A selection of the best recipes from the Miele test kitchen.

Before using for the first time

- Remove any protective wrapping and stickers.
- Do not remove stickers carrying safety or installation information or the data plate.





This makes it easier to perform servicing and repair work.

Cleaning the drawer for the first time

- Remove the anti-slip mat and the rack, if present, from the drawer. Clean them with warm water and a little washing-up liquid applied with a clean sponge or with a clean, damp microfibre cloth.
- Dry the mat and the rack with a soft cloth.
- Wipe the drawer inside and out with a damp cloth to remove any dust or left-over packaging.
- Dry all surfaces with a soft cloth.
- Refit the anti-slip mat and the rack (if applicable) in the drawer.

Heating up the drawer for the first time

Heat the empty drawer for at least 2 hours.

- Switch the drawer on by touching the On/Off  sensor.
- Touch the  sensor repeatedly until the  symbol lights up.
- Touch the  sensor repeatedly until the segment on the far right-hand side of the temperature display lights up.
- Touch the  sensor repeatedly until **2h** lights up.
- Close the drawer.

The drawer is fitted with a contact switch. This ensures that the heating element and fan in the appliance only work when the drawer is closed.

The drawer will switch itself off automatically after 2 hours.

The metal components have a protective coating. This may give off a slight smell when the drawer is heated up for the first time. The smell and any vapours given off will dissipate after a short time and do not indicate a faulty connection or appliance.

Ensure that the kitchen is well ventilated when heating the drawer for the first time.

Before using for the first time

Miele@home

Your drawer is equipped with an integrated Wi-Fi module.

In order to use it, you need:

- a Wi-Fi network
- the Miele@mobile App
- a Miele user account. The user account can be created via the Miele@mobile App.

The Miele@mobile App will guide you as you connect your drawer to your home Wi-Fi network.

Once your drawer is connected to your Wi-Fi network, you can use the App, for example, to carry out the following activities:

- Access information about the operating status of your drawer
- Retrieve information on cooking processes that are in progress
- End cooking programmes that are in progress

Connecting your drawer to your Wi-Fi network will increase energy consumption, even when the drawer is switched off.

Before installing the drawer in its final location, ensure that the signal of your Wi-Fi network is strong enough.

Miele@home availability

The ability to use the Miele@mobile App depends on the availability of the Miele@home service in your country.

The Miele@home service is not available in every country.

For information about availability, please visit www.miele.com.

Miele@mobile App

You can download the Miele@mobile App from the Apple App Store® or the Google Play Store™ free of charge (only functional in selected countries).



Before using for the first time

Connecting via the app

The Miele@mobile App can be used to connect to your network.

- Install the Miele@mobile App on your mobile device.

To log in you will need:

1. Your Wi-Fi network password.
2. The password of your drawer.

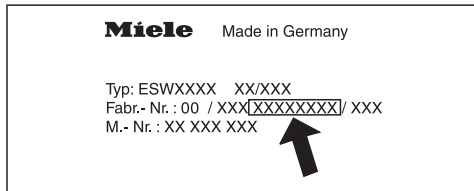

The password for your drawer consists of the last nine digits of the serial number. This can be found on the appliance's data plate.

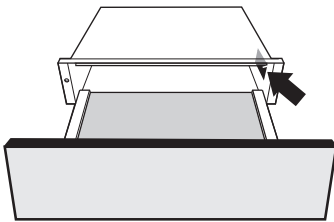

Data plate

The data plate is located here:



- Start signing the appliance on in the app. Follow the signing-in instructions.

When requested to activate Wi-Fi on the drawer, proceed as follows:

- Switch the drawer off.
- Press and hold the  sensor.
- At the same time, touch the  sensor.

2h will light up constantly, **3h** will flash on and off.

The drawer will be ready for connection in the next 10 minutes.

- Follow the instructions in the App.

When successfully connected, **2h** and **3h** will light up constantly.



- Quit the connection mode on the drawer by touching the  sensor.

The drawer can now be operated via the App.

Before using for the first time

Connecting via WPS

Your Wi-Fi router must support WPS (Wi-Fi Protected Setup).

- Switch the drawer off.
- Press and hold the  sensor.
- At the same time, touch the  sensor.

2h will light up constantly, **3h** will flash on and off.

The WPS connection must be started on the drawer at the same time as on the Wi-Fi router.

- Touch the  sensor control on the drawer after a few seconds.

After a short while, **2h** will light up constantly, and **3h** and **4h** will flash on and off.

The drawer will be ready for connection in the next 10 minutes.

- Start the WPS connection on your Wi-Fi router.

When successfully connected, **2h** and **3h** will light up constantly.

- Quit the connection mode on the drawer by touching the  sensor.



The drawer can now be operated via the App.

If the connection fails, you have probably not connected WPS on your router quickly enough. Repeat the steps above.

Useful tip: If your Wi-Fi router does not support WPS, please connect via the Miele@mobile App.

Signing out of Wi-Fi (resetting factory default settings)

To set up a new Wi-Fi connection, the existing Wi-Fi connection must first be disconnected.

- Switch the drawer off.
- Press and hold the  sensor.
- At the same time, touch the  sensor.

With an existing Wi-Fi connection, **2h** and **3h** will light up constantly.

The drawer will be ready for disconnection in the next 10 minutes.

- Touch the  sensor.

2h will light up constantly, **3h** will flash on and off.

After a few seconds, **2h** and **3h** will flash on and off. The connection has been disconnected.

- Quit the signing-off mode on the drawer by touching the  sensor.

The Wi-Fi connection has been disconnected. A new connection can now be set up.

Operation

Operating principles

 Malfunction due to dirty and/or covered sensor controls.

The sensor controls do not react or unintentional switching procedures result, perhaps even automatic switching off of the drawer.





Keep the sensor controls and indicators clean.

Do not place anything over the sensor controls or indicators.

 Damage caused by leaking liquids.

Liquids that get inside the drawer can cause a short circuit.

Open and close the loaded drawer carefully to prevent liquids from spilling.

- Open the drawer.
- Switch the drawer on by touching the  sensor.
- Touch the  sensor repeatedly until the required function lights up.
- Touch the  sensor repeatedly until the segment for the required temperature lights up in the temperature display.
- Touch the  sensor repeatedly until the required operating duration (in hours) lights up.
- Close the drawer.

Using MobileStart





- Touch the  sensor to activate MobileStart.

The indicator light above the  sensor will light up. You will be able to operate the drawer via the Miele@mobile App.

Operation via the sensors has precedence over operation via the App.

Functions

The following functions are available:

-  Warming cups/glasses
-  Warming dishes/plates
-  Keeping food warm
-  Low temperature cooking

The last function selected is automatically activated the next time the drawer is switched on, and appears in the display.

The drawer has a fan which distributes the warm air evenly throughout the drawer. The fan runs continuously with all functions.

The drawer can be used to keep food warm at the same time as warming plates and dishes. Use the  Keeping food warm function for this.

 Danger of burning from hot dishes!

Empty dishes will become very hot when heated using the  Keeping food warm function.

Use oven gloves when removing the dishes.

Duration

 Fire hazard due to dried-out food.

Keeping food warm for a long time can result in it drying out or even self-igniting.

Do not leave the drawer unattended for long periods in continuous operation.

The drawer is set for continuous operation mode (exception: Low temperature cooking). The safety switch-off mechanism will switch off the drawer after a maximum of 12 hours of continuous operation.

A limited operating duration can be selected by touching the  sensor. Touch once for 1 hour (1h), twice for 2 hours (2h), etc., up to a maximum of 4 hours.









Continuous operation is restored by touching the sensor a fifth time.

Operation

Temperature settings

Each operating mode has its own temperature range. The factory default recommended temperatures are printed in bold. The temperature can be altered in 5 °C increments by touching the  sensor.

The last temperature selected is automatically activated the next time the drawer is switched on, and shown in the display (exception: Low temperature cooking).

Temperature display	Temperature [°C]*			
				
	40	60	65	65
	45	65	70	70
	50	70	75	75
	55	75	80	80
	60	80	85	85

* Approximate temperature values, measured in the middle of the drawer when empty

Useful tips

To maintain your food's optimum quality please note the following:

- Place the hot food into pre-heated dishes. Place the empty dishes in the drawer while it pre-heats.
- Do not cover roasted or fried foods which you want to keep crisp. These types of food need to be kept warm at a higher temperature.
- Cover liquids and food with a high moisture content with a suitable lid or heat-resistant foil. This will prevent moisture escaping and condensing outside the dish.
- To avoid spillages, do not overfill dishes.
- Freshly cooked food is hotter than food which is being kept warm. Serve food which has been kept warm on pre-heated plates.
- Nutrients are lost when food is cooked, and continue to diminish when food is kept warm. The longer food is kept warm for, the greater the loss of nutrients.
- We do not recommend food being kept warm for too long, as it will continue to cook.
- Food may cool down if the drawer is opened and closed too often.
- Do not open the drawer too quickly or slam it shut. Liquids could spill over and get into the vents or into the inner parts of the drawer.

 Health risk caused by using too low a temperature.

Bacteria may develop in the food if the temperature used for keeping food warm is too low.

Only use the  Keeping food warm function for keeping food warm.

This function is for keeping food warm which has just been cooked and is still hot. It is not for reheating food that has gone cold.

- Select the  Keeping food warm function.
- Select the desired duration.

Pre-heat the drawer for approx. 15 minutes to ensure that it has reached the required minimum temperature.

- Whilst the appliance is heating up, place the empty dishes in the drawer.
- Remove the pre-heated dishes from the drawer after 15 minutes and fill them with the hot food. Wear oven gloves when removing dishes from the drawer.
- Then place the dishes in the drawer and close it carefully to prevent any liquids from spilling.

Keeping food warm

Settings

Food	Dishes	Cover dish	Temperature for the  setting	Position	
				Floor	Rack*
Steak (rare)	Plate	No	<input checked="" type="checkbox"/> <input type="checkbox"/> <input type="checkbox"/> <input type="checkbox"/> <input type="checkbox"/> <input type="checkbox"/>	x	x
Bakes/Gratins	Shallow dish	Yes	<input type="checkbox"/> <input type="checkbox"/> <input type="checkbox"/> <input checked="" type="checkbox"/> <input type="checkbox"/> <input type="checkbox"/>	x	
Roast	Plate	Yes	<input type="checkbox"/> <input type="checkbox"/> <input checked="" type="checkbox"/> <input type="checkbox"/> <input type="checkbox"/> <input type="checkbox"/>	x	
Casserole	Ovenproof dish	Yes	<input type="checkbox"/> <input type="checkbox"/> <input type="checkbox"/> <input checked="" type="checkbox"/> <input type="checkbox"/> <input type="checkbox"/>	x	
Fish fingers	Pan	No	<input type="checkbox"/> <input type="checkbox"/> <input type="checkbox"/> <input type="checkbox"/> <input type="checkbox"/> <input checked="" type="checkbox"/>	x	
Meat in a sauce	Ovenproof dish	Yes	<input type="checkbox"/> <input type="checkbox"/> <input type="checkbox"/> <input checked="" type="checkbox"/> <input type="checkbox"/> <input type="checkbox"/>	x	
Vegetables in a sauce	Ovenproof dish	Yes	<input type="checkbox"/> <input type="checkbox"/> <input type="checkbox"/> <input checked="" type="checkbox"/> <input type="checkbox"/> <input type="checkbox"/>	x	
Stew	Ovenproof dish	Yes	<input type="checkbox"/> <input type="checkbox"/> <input type="checkbox"/> <input checked="" type="checkbox"/> <input type="checkbox"/> <input type="checkbox"/>	x	
Mashed potato	Ovenproof dish	Yes	<input type="checkbox"/> <input type="checkbox"/> <input checked="" type="checkbox"/> <input type="checkbox"/> <input type="checkbox"/> <input type="checkbox"/>	x	
Plated meal	Plate	Yes	<input type="checkbox"/> <input type="checkbox"/> <input type="checkbox"/> <input checked="" type="checkbox"/> <input type="checkbox"/> <input type="checkbox"/>	x	
Baked potatoes/ New potatoes	Plate/ Ovenproof dish	Yes	<input type="checkbox"/> <input type="checkbox"/> <input checked="" type="checkbox"/> <input type="checkbox"/> <input type="checkbox"/> <input type="checkbox"/>	x	
Schnitzel	Pan	No	<input type="checkbox"/> <input type="checkbox"/> <input type="checkbox"/> <input type="checkbox"/> <input type="checkbox"/> <input checked="" type="checkbox"/>	x	
Pancakes/ Potato cakes	Plate	No	<input type="checkbox"/> <input type="checkbox"/> <input type="checkbox"/> <input type="checkbox"/> <input type="checkbox"/> <input checked="" type="checkbox"/>	x	x
Pizza	Plate	No	<input type="checkbox"/> <input type="checkbox"/> <input type="checkbox"/> <input type="checkbox"/> <input type="checkbox"/> <input checked="" type="checkbox"/>	x	
Boiled potatoes	Ovenproof dish	Yes	<input type="checkbox"/> <input type="checkbox"/> <input type="checkbox"/> <input checked="" type="checkbox"/> <input type="checkbox"/> <input type="checkbox"/>	x	
Gravy	Ovenproof dish	Yes	<input type="checkbox"/> <input type="checkbox"/> <input type="checkbox"/> <input checked="" type="checkbox"/> <input type="checkbox"/> <input type="checkbox"/>	x	
Strudel	Plate	No	<input type="checkbox"/> <input type="checkbox"/> <input type="checkbox"/> <input checked="" type="checkbox"/> <input type="checkbox"/> <input type="checkbox"/>	x	
Warming bread	–	No	<input checked="" type="checkbox"/> <input type="checkbox"/> <input type="checkbox"/> <input type="checkbox"/> <input type="checkbox"/> <input type="checkbox"/>	x	x

Keeping food warm

Food	Dishes	Cover dish	Temperature for the  setting	Position	
				Floor	Rack*
Warming bread rolls	–	No	<input checked="" type="checkbox"/> <input type="checkbox"/> <input type="checkbox"/> <input type="checkbox"/> <input type="checkbox"/>	x	x

* depending on model

Warming crockery

Useful tips

- Distribute the crockery over the whole area of the drawer. Stacks of plates heat up more slowly than individual pieces of crockery. If you cannot avoid stacking plates, place them at the front of the drawer. Use the rack (depending on model).
- Do not place large serving dishes right up against the vents. They will cover the warm air outlets. The crockery will not heat up evenly.
- For cups and glasses, only select the  Warming cups/glasses function to ensure that the maximum temperature (60 °C) is not exceeded.
- Heated crockery cools down very quickly. Do not remove it from the drawer until just before you need it.

Heating-up times

Various factors will affect the heating-up times:

- The material and thickness of the crockery
- Load size
- How the crockery is arranged
- The temperature setting

It is therefore not possible to state precise times. For even heating with the  Warming dishes/plates function, the following values can be used as a guide:

- 30–35 minutes for 6 place settings to heat up evenly
- 40–45 minutes for 12 place settings to heat up evenly

As you use the warming drawer, you will get to know which setting suits your own needs best.

Capacity

 Risk of damage due to overloading.

Overloading the drawer will damage the telescopic runners.

The maximum load bearing capacity of the drawer is **25 kg**.

The quantity that can be loaded will depend to a great extent on the size and weight of your crockery.

ESW 7020, ESW 7030, ESW 7120: the loading area can be increased by using the rack supplied with the drawer. Position the rack to suit. With two racks you can increase the loading area even more by placing one rack on the left and the other on the right. An additional rack can be obtained from the Miele online shop, or directly from Miele (see “Optional accessories”).

ESW 7010, ESW 7110

The loading examples shown here are suggestions:

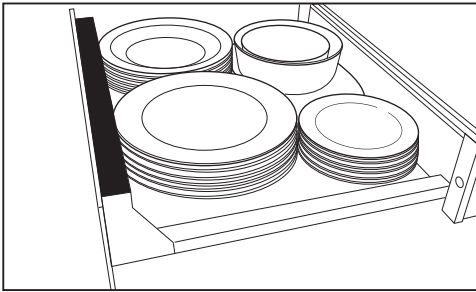

6 place settings

6 dinner plates	Ø 26 cm
6 soup bowls	Ø 23 cm
6 dessert plates	Ø 19 cm
1 oval serving dish	32 cm
1 serving dish	Ø 16 cm
1 serving dish	Ø 13 cm

or alternatively

12 dinner plates	Ø 26 cm
18 soup bowls	Ø 23 cm
16 soup cups	Ø 10 cm
6 dinner plates and 6 soup bowls	Ø 26 cm Ø 23 cm
6 pizza plates	Ø 36 cm
72 espresso cups	Ø 5.9 cm
30 cappuccino cups	Ø 8.8 cm
30 punch glasses	Ø 6.7 cm (8 cm tall)

Warming crockery

ESW 7020, ESW 7030, ESW 7120

The loading examples shown here are suggestions:

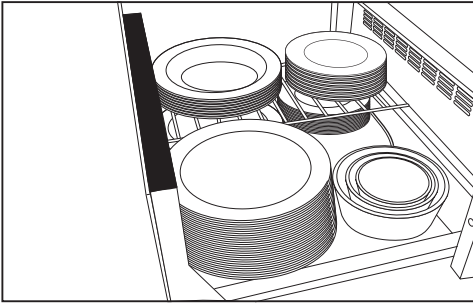

12 place settings

12 dinner plates	Ø 26 cm
12 soup bowls	Ø 23 cm
12 dessert plates	Ø 19 cm
1 oval serving dish	32 cm
1 serving dish	Ø 19 cm
1 serving dish	Ø 16 cm
1 serving dish	Ø 13 cm

or alternatively

40 dinner plates	Ø 26 cm
60 soup bowls	Ø 23 cm
45 soup cups	Ø 10 cm
20 dinner plates	Ø 26 cm
20 soup bowls	Ø 23 cm
20 pizza plates	Ø 36 cm
142 espresso cups	Ø 5.9 cm
90 cappuccino cups	Ø 8.8 cm
30 punch glasses	Ø 6.7 cm (8 cm tall)

With low temperature cooking, food is cooked at a low temperature over a long period of time. Using this method, food loses less liquid as it is cooked gently and so remains succulent and tender.

If food probes from other Miele built-in appliances are used in the drawer, they may affect the built-in appliances.

Only use the Miele built-in appliance food probe with the built-in appliance that it was supplied with.

For precision, we recommend using a proprietary food probe to monitor the core temperature. The food can then be cooked to an exact temperature.

Core temperature

Food can be cooked to a core temperature of up to 70 °C in the drawer. Food which needs to be cooked to a core temperature higher than 70 °C is not suitable for cooking in the drawer.

The core temperature indicates the degree of doneness in the middle of the food.

For meat, the lower the core temperature, the less cooked the meat is in the middle:

- 45–50 °C = rare
- 55–60 °C = medium
- 65 °C = well-done

Cooking duration

The cooking duration depends on the size of the food, and can be between 1 and 6 hours.

Pre-heat the drawer with the suitable cooking containers for 15 minutes. This ensures that the dishes and the interior of the drawer reach the required temperature.

Example:

Selected duration 1h

Actual operating time 1 hour 15 minutes

Notes

- Use meat that has been properly hung.
- The quality of the food is of vital importance for a good result.
- The food must be at room temperature. Take it out of the fridge about 15 minutes before cooking.

Low temperature cooking

Using the Low temperature cooking function

- Select the  Low temperature cooking function.
- Place an ovenproof dish on the floor of the drawer.

The drawer will pre-heat automatically for 15 minutes and then operate at the preset temperature of 85 °C for a preset duration of 4 h.

If you wish to cook using different settings, please consult the cooking charts on the following pages.

- If necessary, select the desired temperature.
- If necessary, select the desired duration.
- After pre-heating, put the food in the dish.
- If using a food probe:
Push the food probe into the food so that the tip is in the centre. Make sure that it does not come into contact with bones or layers of fat as these can cause a false reading.
- When the temperature is approx. 10 °C (guide value) below the core temperature given in the cooking chart, remove the food from the drawer.

A smaller temperature difference is recommended for large portions of food.

- Sear the food on all sides over a high heat on the cooktop.

Useful tips

- Do not cook the food all the way through. Sear the food straight after cooking.
- The food can be sliced straight away. It does not need to rest.
- Serve the food on pre-heated plates to stop it cooling too quickly.





Low temperature cooking

Pre-heat the cooking container for 15 minutes. In this time, rest the food at room temperature.

Place the food into the pre-heated cooking container in the drawer.

The durations given in the charts are guidelines only. The food can be cooked further if required.





Beef cooking chart

Cut of meat	 [min]	 * [°C]	 [min]	
Medallions 3–4 cm thick	1 per side	45–50	45–60	<input type="checkbox"/> <input type="checkbox"/> <input checked="" type="checkbox"/> <input type="checkbox"/> <input type="checkbox"/>
	1–2 per side	55–60	65–80	<input type="checkbox"/> <input type="checkbox"/> <input type="checkbox"/> <input checked="" type="checkbox"/> <input type="checkbox"/>
	2 per side	65	95–110	<input type="checkbox"/> <input type="checkbox"/> <input type="checkbox"/> <input type="checkbox"/> <input checked="" type="checkbox"/>
Sirloin steak approx. 170 g	1 per side	45–50	45–60	<input type="checkbox"/> <input type="checkbox"/> <input checked="" type="checkbox"/> <input type="checkbox"/> <input type="checkbox"/>
	2 per side	55–60	65–80	<input type="checkbox"/> <input type="checkbox"/> <input type="checkbox"/> <input checked="" type="checkbox"/> <input type="checkbox"/>
	2 per side	65	95–110	<input type="checkbox"/> <input type="checkbox"/> <input type="checkbox"/> <input type="checkbox"/> <input checked="" type="checkbox"/>
Rump steak approx. 200 g	1 per side	45–50	35–45	<input type="checkbox"/> <input type="checkbox"/> <input checked="" type="checkbox"/> <input type="checkbox"/> <input type="checkbox"/>
	1–2 per side	55–60	45–60	<input type="checkbox"/> <input type="checkbox"/> <input type="checkbox"/> <input checked="" type="checkbox"/> <input type="checkbox"/>
	2 per side	65	95–110	<input type="checkbox"/> <input type="checkbox"/> <input type="checkbox"/> <input type="checkbox"/> <input checked="" type="checkbox"/>

* 45–50 °C rare/55–60 °C medium/65 °C well done

 Searing time/ Core temperature/ Duration/ Temperature setting

Veal cooking chart





Cut of meat	 [min]	 * [°C]	 [min]	
Medallions 3–4 cm thick	1 per side	45–50	40–55	<input type="checkbox"/> <input type="checkbox"/> <input checked="" type="checkbox"/> <input type="checkbox"/> <input type="checkbox"/>
	2 per side	55–60	60–75	<input type="checkbox"/> <input type="checkbox"/> <input type="checkbox"/> <input checked="" type="checkbox"/> <input type="checkbox"/>
	2 per side	65	90–105	<input type="checkbox"/> <input type="checkbox"/> <input type="checkbox"/> <input type="checkbox"/> <input checked="" type="checkbox"/>
Steak approx. 160 g 2 cm thick	1 per side	45–50	15–30	<input type="checkbox"/> <input type="checkbox"/> <input checked="" type="checkbox"/> <input type="checkbox"/> <input type="checkbox"/>
	2 per side	55–60	30–45	<input type="checkbox"/> <input type="checkbox"/> <input type="checkbox"/> <input checked="" type="checkbox"/> <input type="checkbox"/>
	2 per side	65	65–80	<input type="checkbox"/> <input type="checkbox"/> <input type="checkbox"/> <input type="checkbox"/> <input checked="" type="checkbox"/>

* 45–50 °C rare/55–60 °C medium/65 °C well done

 Searing time/ Core temperature/ Duration/ Temperature setting

Low temperature cooking





Pork cooking chart

Cut of meat	 [min]	 * [°C]	 [min]	
Fillet approx. 550 g	6–8 total	65	90–110	<input type="checkbox"/> <input type="checkbox"/> <input type="checkbox"/> <input type="checkbox"/> <input checked="" type="checkbox"/>
Medallions approx. 4 cm thick	2 per side	65	85–100	<input type="checkbox"/> <input type="checkbox"/> <input type="checkbox"/> <input type="checkbox"/> <input checked="" type="checkbox"/>

* 65 °C well done

 Searing time/ Core temperature/ Duration/ Temperature setting

Lamb cooking chart

Cut of meat	 [min]	 * [°C]	 [min]	
Rack of lamb approx. 170 g	2–4	60	45–60	<input type="checkbox"/> <input type="checkbox"/> <input type="checkbox"/> <input checked="" type="checkbox"/> <input type="checkbox"/>
	2–4	65	85–100	<input type="checkbox"/> <input type="checkbox"/> <input type="checkbox"/> <input type="checkbox"/> <input checked="" type="checkbox"/>
Rack of lamb approx. 400 g	2–4	60	45–60	<input type="checkbox"/> <input type="checkbox"/> <input type="checkbox"/> <input checked="" type="checkbox"/> <input type="checkbox"/>
	2–4	65	85–100	<input type="checkbox"/> <input type="checkbox"/> <input type="checkbox"/> <input type="checkbox"/> <input checked="" type="checkbox"/>
Boned rack of lamb approx. 600 g	2 per side	60	45–60	<input type="checkbox"/> <input type="checkbox"/> <input type="checkbox"/> <input checked="" type="checkbox"/> <input type="checkbox"/>
	2 per side	65	95–110	<input type="checkbox"/> <input type="checkbox"/> <input type="checkbox"/> <input type="checkbox"/> <input checked="" type="checkbox"/>

* 60 °C medium/65 °C well done

 Searing time/ Core temperature/ Duration/ Temperature setting

Game cooking chart





Cut of meat	 [min]	 * [°C]	 [min]	
Venison medallions 3–4 cm thick	2 per side	60	65–80	<input type="checkbox"/> <input type="checkbox"/> <input type="checkbox"/> <input type="checkbox"/> <input checked="" type="checkbox"/>
	2 per side	65	95–110	
Saddle of roebuck off the bone approx. 800 g	2 per side	60	55–70	<input type="checkbox"/> <input type="checkbox"/> <input type="checkbox"/> <input type="checkbox"/> <input checked="" type="checkbox"/>
	2 per side	65	95–110	

* 60 °C medium/65 °C well done

 Searing time/ Core temperature/ Duration/ Temperature setting

Low temperature cooking

Fish cooking chart

Type of fish	 [min]	 [°C]	 [min]	
Salmon 400 g	2 on the skin side	52	45–60	<input type="checkbox"/> <input type="checkbox"/> <input type="checkbox"/> <input type="checkbox"/> <input checked="" type="checkbox"/>
Trout (whole) approx. 350 g	2 per side	52	15–30	<input type="checkbox"/> <input type="checkbox"/> <input type="checkbox"/> <input type="checkbox"/> <input checked="" type="checkbox"/>
Cod 200 g	No searing	52	75–90	<input type="checkbox"/> <input type="checkbox"/> <input type="checkbox"/> <input type="checkbox"/> <input checked="" type="checkbox"/>
Sea bream (whole) approx. 480–500 g	2 per side	52	25–40	<input type="checkbox"/> <input type="checkbox"/> <input type="checkbox"/> <input type="checkbox"/> <input checked="" type="checkbox"/>
Sea bass (whole) approx. 480–500 g	2 per side	52	20–35	<input type="checkbox"/> <input type="checkbox"/> <input type="checkbox"/> <input type="checkbox"/> <input checked="" type="checkbox"/>

 Searing time/ Core temperature/ Duration/ Temperature setting

Other uses

Food	Cooking container	Cover the dish?	☹️	☹️	⌚ [h:min]
Defrosting berries	Bowl / Plate	No	■ □ □ □ □		00:50
Dissolving gelatine	Bowl	No	□ □ □ □ ■		00:15
Proving yeast dough	Bowl	Yes, with plate		■ □ □ □ □	00:30
Making yoghurt	Yoghurt jars with lid	-		□ ■ □ □ □	05:00
Rice pudding (to finish off the cooking process)	Oven-safe dish	Yes, with lid	□ □ □ □ ■		00:40
Melting chocolate	Bowl	No	□ □ □ □ ■		00:20
Defrosting frozen vegetables	Bowl	No	□ □ ■ □ □		01:00

☹️ Temperature setting / ☹️ Temperature setting / ⌚ Duration

Networking with Miele built-in appliances

Networking enables the drawer to operate automatically depending on the operational status of another Miele built-in appliance.

Example:

The drawer heats dishes at the right time before or after using the networked built-in appliance.

Pre-requisites

The following conditions must be met for networking the drawer with other built-in appliances:

- The drawer is connected to the household Wi-Fi network via Miele@home.
- The other built-in appliance is connected to the household Wi-Fi network via Miele@home.

Carrying out the networking

Networking is carried out via the Miele@mobile App as normal.



See “Before using for the first time – Setting up Miele@home” as well as the Miele@mobile App for detailed information about this function.

Operation via the sensors has precedence over operation via the App.

Sabbath mode

For religious observance, the drawer can be programmed for the duration of the Sabbath. This mode switches off automatically after about 72 hours and the drawer resumes normal operation. When this function is activated, the timer is deactivated and the sensor controls must be touched for longer than usual.

Activating

- If necessary, switch the drawer off.
 - Press and hold the  sensor.
 - At the same time, touch the  sensor.
- 1h, 2h, 3h** and **4h** will light up.
- Set the required mode and temperature.

Deactivating

You can deactivate the Sabbath mode before the time has expired.

- Press and hold the  sensor.

All displays will switch off.

The drawer is in normal mode again.

 Risk of damage due to moisture ingress.

The steam from a steam cleaning appliance could reach electrical components and cause a short circuit.

Do not use a steam cleaner to clean the drawer.

The use of unsuitable cleaning agents can cause the surfaces to discolour or alter. All surfaces are susceptible to scratching. Scratches on glass surfaces could cause a breakage in certain circumstances.

Remove any residual cleaning agent immediately.

Never use abrasive sponges or cleaning agents.

 Danger of burning on the hot interior!

The interior of the drawer will be hot after use.

Allow the drawer to cool down to a safe temperature before cleaning.

- The drawer and accessories should be cleaned and dried after each use.

Unsuitable cleaning agents

To avoid damaging the surfaces of your appliance, do not use:

- cleaning agents containing soda, alkalines, ammonia, acids or chlorides
- cleaning agents containing descaling agents
- abrasive cleaning agents, e.g. powder cleaners and cream cleaners
- solvent-based cleaning agents
- stainless steel cleaners
- cleaning agents for ceramic cooktops
- dishwasher cleaner
- oven cleaners or sprays
- glass cleaning agents
- hard, abrasive sponges and brushes, e.g. pot scourers
- sharp metal scrapers

Cleaning and care

Cleaning the drawer front and interior

 Malfunction due to dirty and/or covered sensor controls.

The sensor controls do not react or unintentional switching procedures result, perhaps even automatic switching off of the drawer.

Keep the sensor controls and indicators clean.

Do not place anything over the sensor controls or indicators.

- Remove all soiling using a solution of hot water and washing-up liquid applied with a sponge or use a clean, damp microfibre cloth.
- Wipe with clean water afterwards.
- After cleaning, wipe the surfaces dry using a soft cloth.

Cleaning the anti-slip mat

 Damage caused by incorrect cleaning.

Washing the anti-slip mat in a dishwasher or washing machine will damage it.

The anti-slip mat should only be cleaned by hand.

 Damage caused by incorrect drying.

Drying the anti-slip mat in an oven will damage it.



Never place it in the oven to dry.

- Remove the anti-slip mat from the drawer.
- Clean the anti-slip mat using a solution of hot water and a little washing-up liquid.
- Afterwards dry the anti-slip mat with a soft cloth.
- Only replace the anti-slip mat in the drawer when it is completely dry.



Problem solving guide

With the help of the following guide, minor faults in the performance of the appliance, some of which may result from incorrect operation, can be remedied without contacting Miele. This will save you time and money because you won't need a service call.

Please note that a call-out charge will be applied to unnecessary service visits where the problem could have been rectified as described in these operating instructions.

Problem	Possible cause and remedy
The drawer does not heat up.	The appliance is not correctly plugged in and switched on at the mains socket. ■ Insert the plug and switch on at the socket.
	The circuit breaker has tripped. ■ Reset the circuit breaker in the mains fuse box (see data plate for minimum fuse rating). If, after resetting/replacing the trip switch in the fuse box or the residual current protection device, the drawer will still not switch on, contact a qualified electrician or Miele.
A noise can be heard when the drawer is in use.	The noise is caused by the fan which distributes the heat evenly throughout the drawer. This is not a fault.
The food is not hot enough.	The function for keeping food warm  is not selected. ■ Select the correct function.
	The temperature setting is too low. ■ Check that the doors have been closed properly. ■ Select a higher temperature.
	The vents have been covered up. ■ Ensure that the air can circulate freely.
The food is too hot.	The function for keeping food warm  is not selected. ■ Select the correct function.
	The temperature setting is too high. ■ Select a lower temperature.

Problem solving guide

Problem	Possible cause and remedy
The crockery is not warm enough.	The  function for warming plates and dishes has not been selected. ■ Select the correct function.
	The temperature setting is too low. ■ Select a higher temperature.
	The air vents are covered. ■ Ensure that the air can circulate freely.
	The crockery has not been allowed to heat up for a sufficiently long time. ■ Various factors affect how long crockery takes to heat up (see “Warming crockery”).
The crockery is too hot.	The  Warming plates/dishes or  Warming cups/glasses function has not been selected. ■ Select the correct function.
	The temperature setting is too high. ■ Select a lower temperature.

Miele offers a range of useful accessories, as well as cleaning and conditioning products for your appliance.

These products can be ordered from the Miele online shop.

They can also be ordered directly from Miele (see end of this booklet for contact details).

Rack

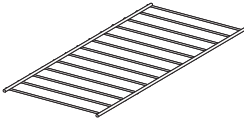

For increasing the loading area (ESW 7020, ESW 7030, ESW 7120).

Anti-slip mat

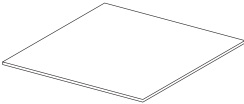

For keeping dishes secure.

Original Miele all purpose microfibre cloth

Removes finger marks and light soiling.

Safety instructions for installation



Risk of damage from incorrect installation.

Incorrect installation can cause damage to the drawer and/or the combination appliance.

The appliance must only be installed by a suitably qualified and competent person.

- ▶ The socket and on-off switch should be easily accessible after the drawer has been installed.
- ▶ The drawer may only be installed in combination with those appliances quoted by Miele as being suitable. If the drawer is used in combination with other appliances, the warranty will be invalidated, as trouble-free operation cannot be guaranteed.
- ▶ The base on which the drawer and the combination appliance are fitted must be fixed in place and must support the weight of both appliances.
- ▶ When building in the combination appliance, it is essential to follow the instructions given in the operating and installation instructions supplied with it.
- ▶ The warming drawer must be installed in such a way that:
 - The contents of the dishes can be seen when it is opened. This is to avoid scalding from hot food spilling over.
 - There is enough space for the drawer to be pulled out fully.

The drawer can be used in combination with the following Miele built-in appliances:

- all 60 cm wide ovens
- all 60 cm wide steam ovens
- all 60 cm wide coffee machines
- all 60 cm wide microwave ovens
- the 60 cm wide Dialog oven

The combination appliance is placed on top of the drawer without the need for an interim shelf.

The drawer is available in 3 models, which differ in height. The building-in dimensions for the drawer must be added to the building-in dimensions for the combination appliance to establish the niche size required.

Installation dimensions ESW 7010, ESW 7110

All dimensions in this instruction booklet are given in mm.

Combination appliance with a height of 45 cm

The furniture housing unit must not have a back panel fitted behind the building-in niche.

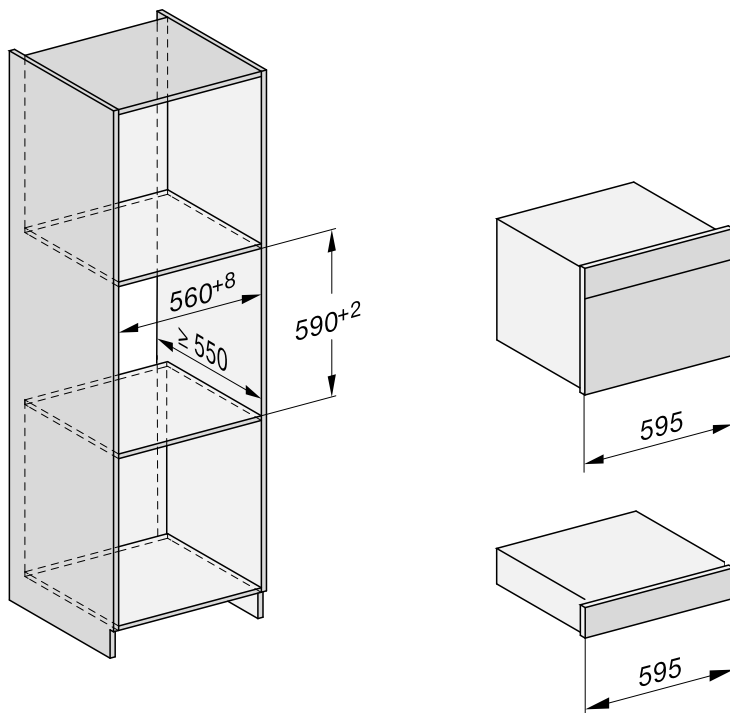

Installation dimensions ESW 7010, ESW 7110

Combination appliance with a height of 60 cm

The furniture housing unit must not have a back panel fitted behind the building-in niche.

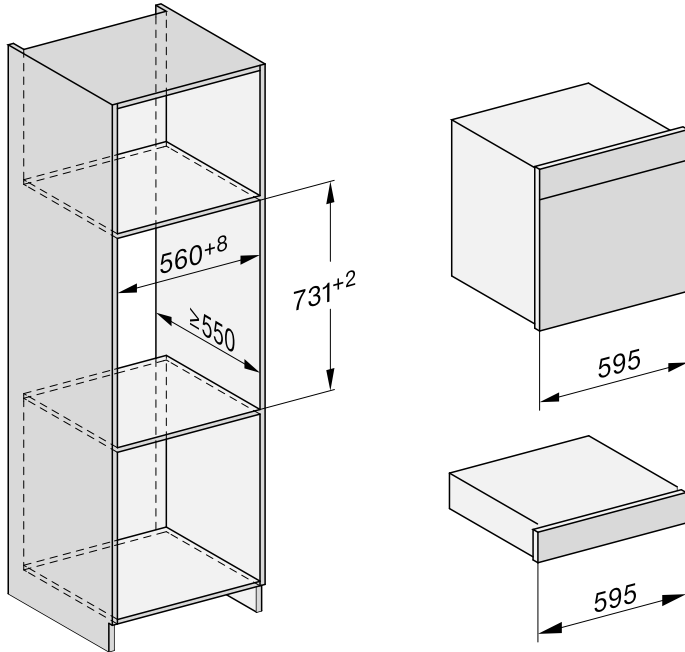

Installation dimensions ESW 7010, ESW 7110

Side view

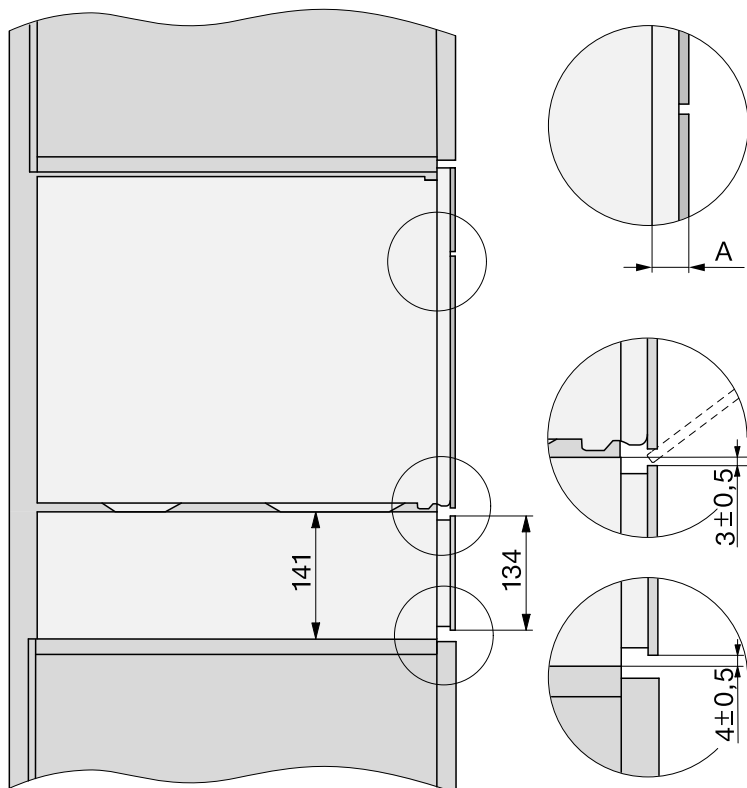

A Glass front: 22 mm

Metal front: 23.3 mm

Installation dimensions ESW 7010, ESW 7110

Connections and ventilation

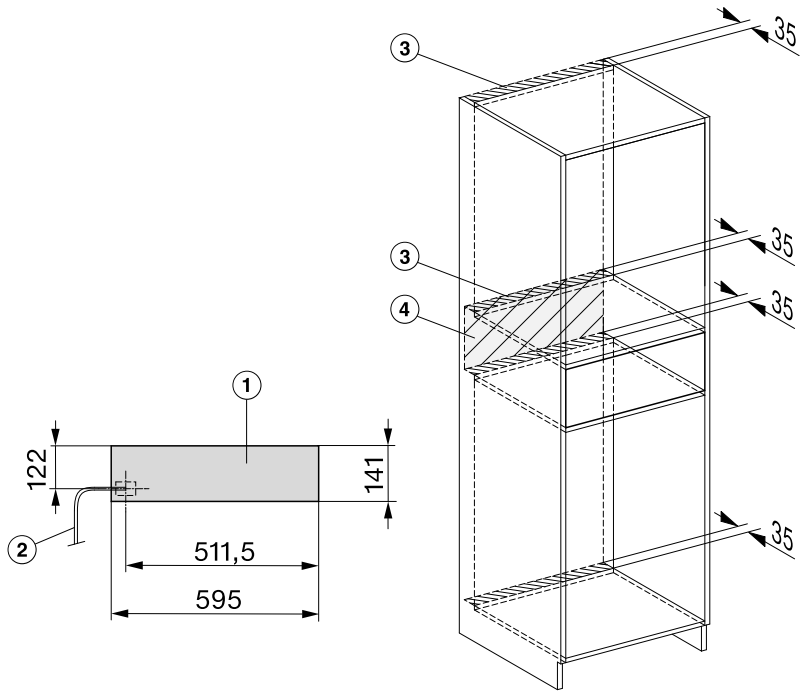

- ① Front view
- ② Mains connection cable, L = 2,000 mm
- ③ Ventilation cut-out, min. 180 cm²
- ④ No connections permitted in this area

Installation dimensions ESW 7020, ESW 7120

All dimensions in this instruction booklet are given in mm.

Combination appliance with a height of 45 cm

The furniture housing unit must not have a back panel fitted behind the building-in niche.

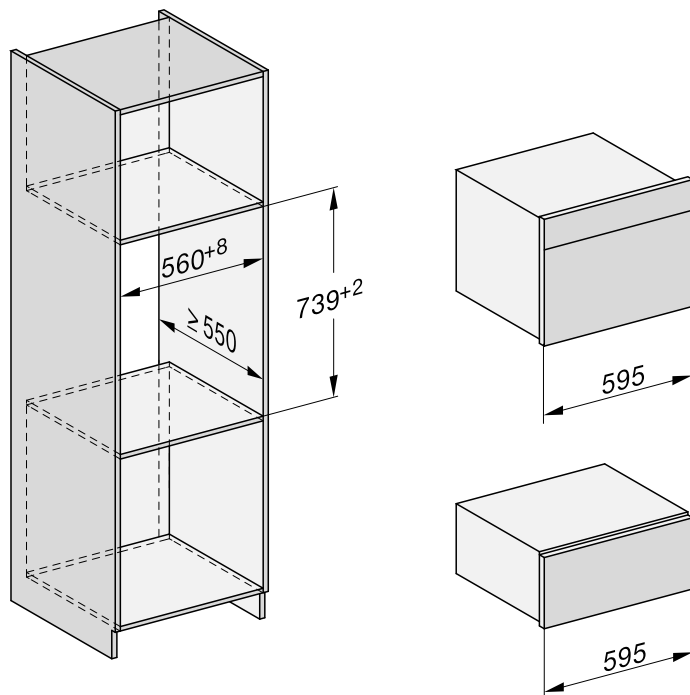

Installation dimensions ESW 7020, ESW 7120

Combination appliance with a height of 60 cm

The furniture housing unit must not have a back panel fitted behind the building-in niche.

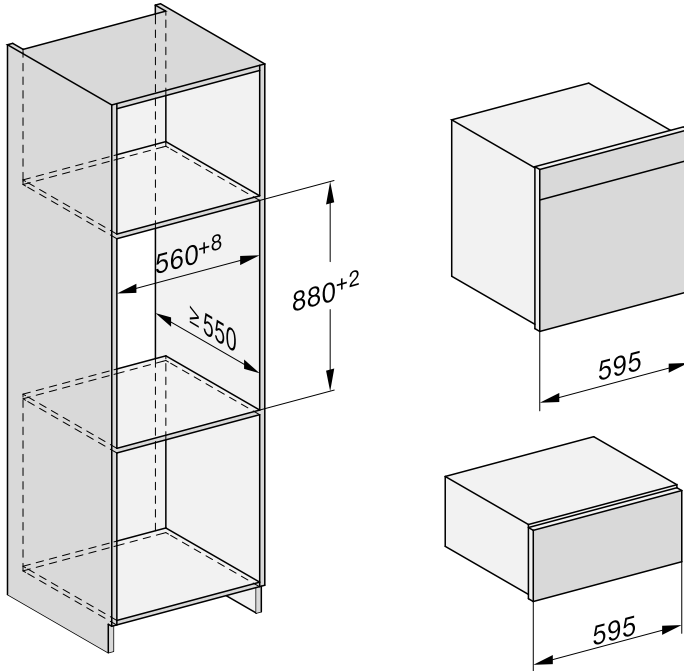

Installation dimensions ESW 7020, ESW 7120

Side view

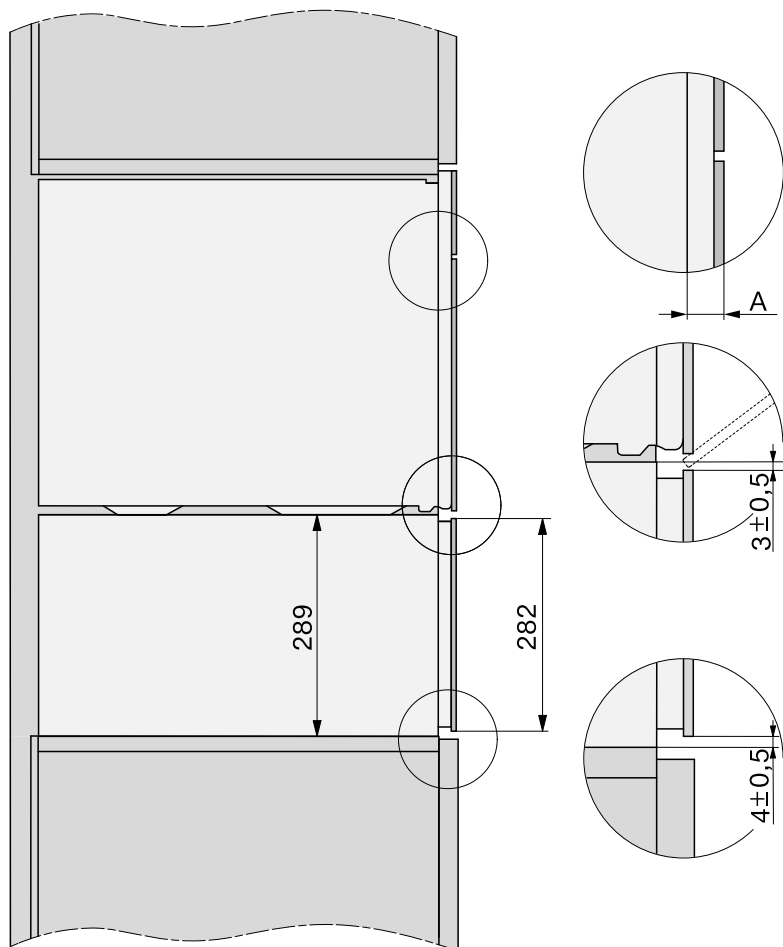

- A** Glass front: 22 mm
- Metal front: 23.3 mm

Connections and ventilation

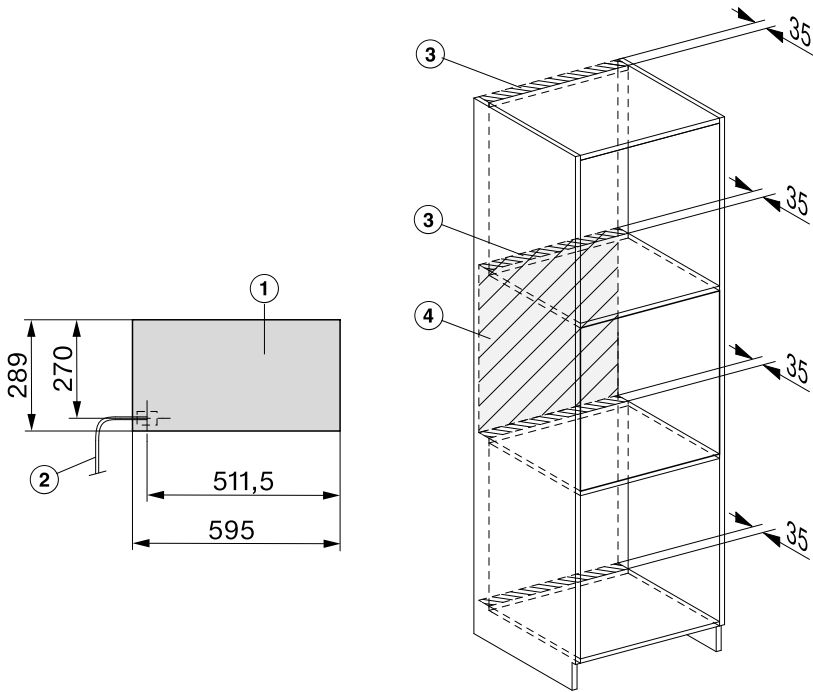

- ① Front view
- ② Mains connection cable, L = 2,000 mm
- ③ Ventilation cut-out, min. 180 cm²
- ④ No connections permitted in this area

Installation dimensions ESW 7030

All dimensions in this instruction booklet are given in mm.

Combination appliance with a height of 45 cm

The furniture housing unit must not have a back panel fitted behind the building-in niche.

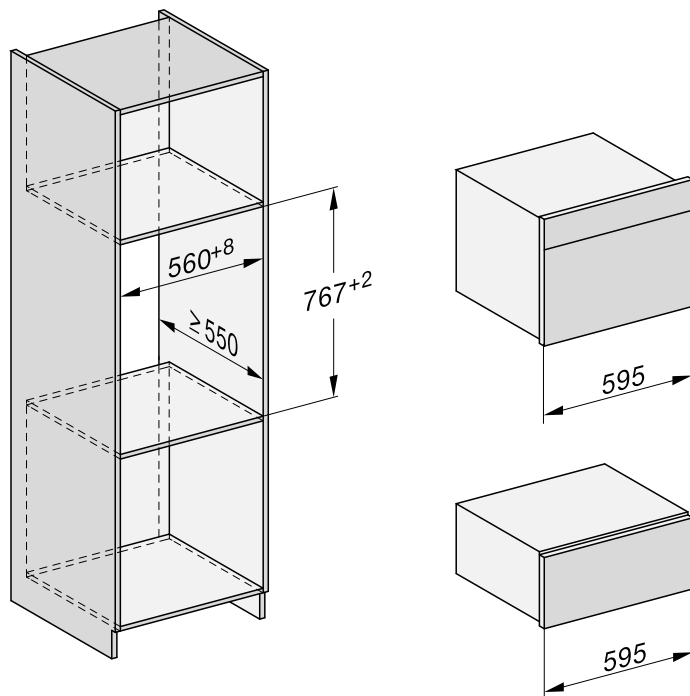

Installation dimensions ESW 7030

Combination appliance with a height of 60 cm

The furniture housing unit must not have a back panel fitted behind the building-in niche.

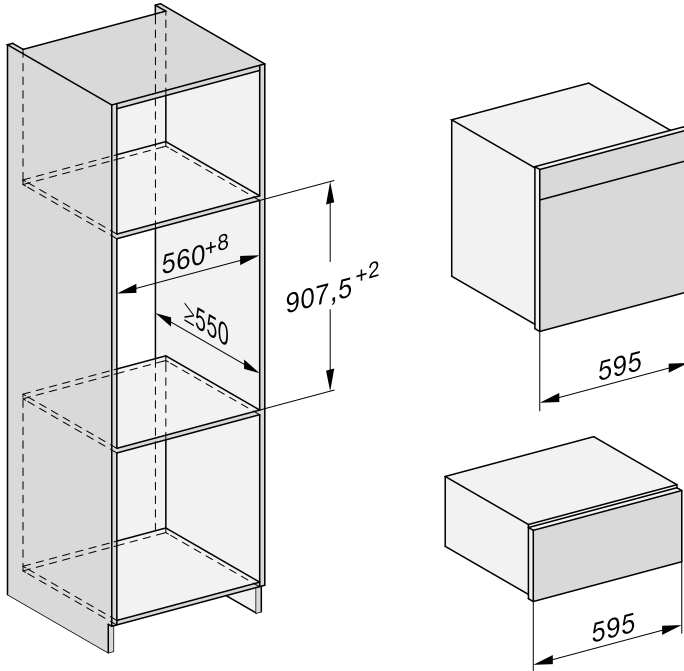

Installation dimensions ESW 7030

Side view

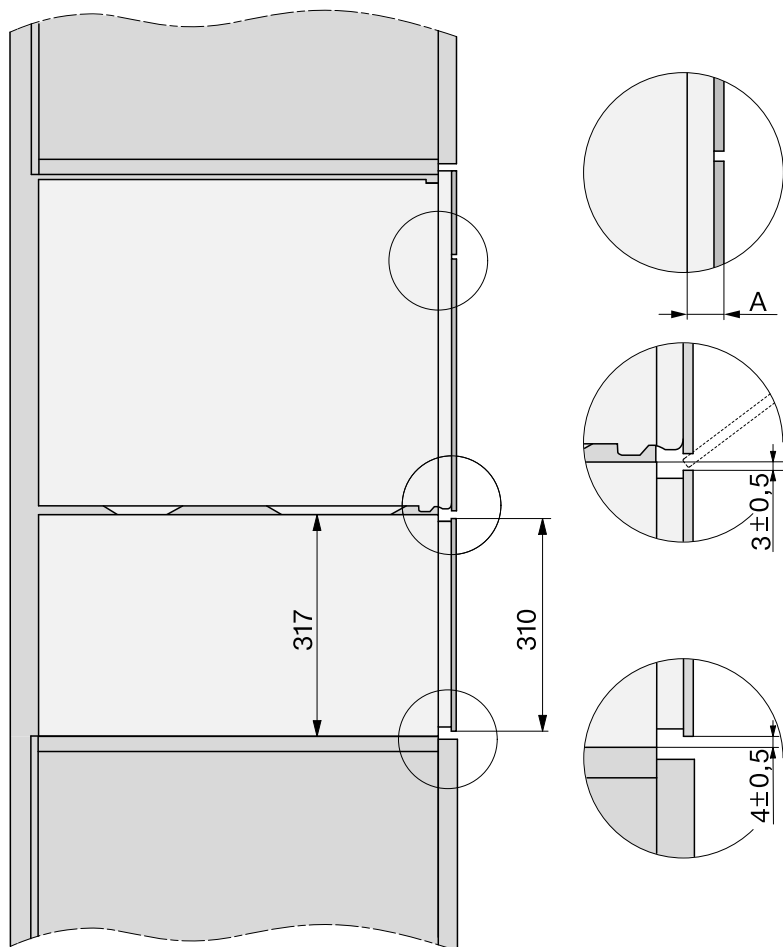

- A** Glass front: 22 mm
- Metal front: 23.3 mm

Connections and ventilation

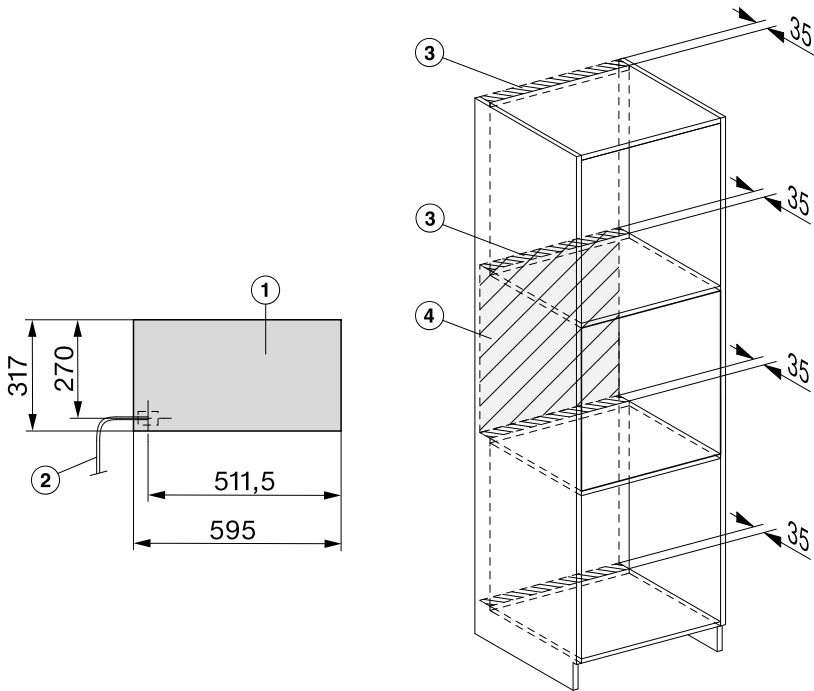

- ① Front view
- ② Mains connection cable, L = 2,000 mm
- ③ Ventilation cut-out, min. 180 cm²
- ④ No connections permitted in this area

Installation

Check that the base on which the drawer will sit is clean and level (use a spirit level). This is important for the appliance to function correctly.

- Push the drawer into the furniture unit up to the vapour strip and make sure it is correctly aligned in the unit.

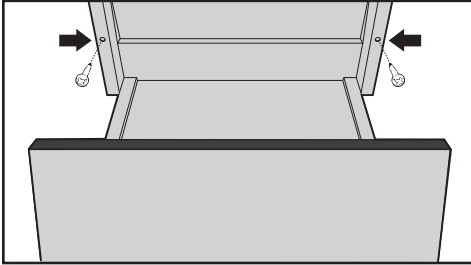

- Open the drawer and use the 2 screws supplied to secure it to the side walls of the furniture unit.
- Build in the combination appliance in accordance with the operating and installation instructions supplied with it.

We recommend that you connect the drawer to the mains electricity via a suitable switched electrical socket. This simplifies servicing. The socket and on-off switch should be easily accessible after the drawer has been installed.

 Danger of injury due to unauthorised installation, maintenance and repairs.

Danger of injury! Miele cannot be held liable for unauthorised installation, maintenance and repair work as this can be dangerous to users.

Miele cannot be held liable for damage or injury (e.g. electric shock) caused by the lack of or inadequacy of an on-site earthing system.

If the plug is removed from the connection cable or if the cable is supplied without a plug, the drawer must be connected to the electricity supply by a suitably qualified and competent electrician.

If the socket is no longer accessible, or if a hard-wired connection is planned, an additional means of disconnection must be provided for all poles. Suitable means of disconnection include switches with an all-pole contact gap of at least 3 mm. These include miniature circuit breakers, fuses and relays. The connection data is given on the data plate. Please ensure this information matches the household mains electricity supply.

After installation, ensure that all electrical components are shielded and cannot be accessed by users.

Total power output

See data plate.

Connection data

The connection data is given on the data plate. Please ensure this information matches the household mains supply.

Residual current device

For extra safety, it is advisable to protect the drawer with a suitable residual current device (RCD) with a trip range of 30 mA.

Electrical connection

Replacing the mains connection cable

If replacing the mains connection cable, it must be replaced with a cable type H 05 VV-F (rubber insulated), available from Miele, by a suitably qualified and competent electrician.

Contact in case of fault

In the event of any faults which you cannot remedy yourself, please contact Miele.

Contact information for Miele can be found at the end of this booklet.

Please quote the model and serial number of your appliance when contacting Miele. This information can be found on the data plate.

Data plate

The data plate is located here:

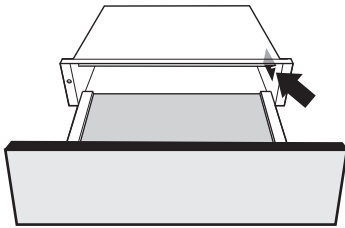

Warranty

The manufacturer's warranty for this appliance is 2 years.

For further information, please refer to your warranty booklet.

Miele Australia Pty. Ltd.

ACN 005 635 398
ABN 96 005 635 398

**Miele Experience Centre and
Head Office Melbourne:**

1 Gilbert Park Drive
Knoxfield, VIC 3180

Miele Experience Centre South Melbourne:

206-210 Coventry Street
South Melbourne, VIC 3205

Miele Experience Centre and Office Sydney:

3 Skyline Place
Frenchs Forest, NSW 2086

Miele Experience Centre and Office Brisbane:

Tenancy 4C, 63 Skyring Terrace
Newstead, QLD 4006

Miele Experience Centre Gold Coast:

131 Ferry Road
Southport, QLD 4215

Miele Experience Centre and Office Adelaide:

83-85 Sir Donald Bradman Drive
Hilton, SA 5033

Miele Experience Centre and Office Perth:

205-207 Stirling Highway
Claremont, WA 6010



www.miele.com.au

The Miele logo is displayed in white, bold, sans-serif font against a solid black rectangular background.

Miele New Zealand Limited

IRD 98 463 631

Head Office:

Level 2, 10 College Hill
Freemans Bay, Auckland 1011

**Miele Experience Centre
Auckland:**

8 College Hill
Freemans Bay, Auckland 1011
Telephone:
0800 464 353 (0800 4 MIELE)
www.miele.co.nz

Miele Global Headquarters

Germany

Miele & Cie. KG

Carl-Miele-Straße 29
33332 Gütersloh
Federal Republic of Germany

ESW 7010, ESW 7020, ESW 7030, ESW 7110, ESW 7120

en-AU, NZ

M.-Nr. 11 227 100 / 00