

the AquaStation™ Chilled + Hot

Instruction Book - Suits all LWA600 Models



Breville®



Contents

- 2 Breville Recommends Safety First
- 8 Components
- 12 Features
- 14 Assembly
- 17 Operation
- 22 Tea Insights
- 23 Descaling
- 25 Care, Cleaning & Storage
- 27 Troubleshooting

BREVILLE RECOMMENDS SAFETY FIRST

At Breville we are very safety conscious. We design and manufacture consumer products with the safety of you, our valued customer, foremost in mind. In addition, we ask that you exercise a degree of care when using any electrical appliance and adhere to the following precautions. Misuse can cause potential injuries.

MAIN TECHNICAL SPECIFICATIONS

Product Model	LWA600BSS
Filter Model	LWA063WHT
Filter Life	90 days or approximately 200L, whichever comes first
Rated Voltage	220-240V
Rated Frequency	50Hz
Rated Power Consumption	1950-2300 Watts
Applicable Water Source	Municipal tap water: 5-40°C
Product Dimensions (LxWxH)	Approx. 391 x 273x 455
Weight (kg)	10.28Kg

Tested against: NSF/ANSI Standard 42 for the reduction of chlorine (taste and odour), & NSF/ANSI 372, lead content.

Tested to remove/reduce microplastics, floating particles/sediment, pesticides, chlorine, limescale & heavy metals.

Testing was performed under standard laboratory conditions. The contaminants or other substances removed or reduced by this filter are not necessarily in all users' water. Filter performance may vary based on local water conditions.

IMPORTANT SAFEGUARDS

READ ALL INSTRUCTIONS BEFORE USE AND SAVE FOR FUTURE REFERENCE

- Carefully read all instructions before operating and save for future reference.
- Remove and safely discard any packaging material and promotional labels before using the AquaStation™ Chilled + Hot for the first time.
- Always ensure the appliance is properly assembled before use.

Follow the instructions provided in this book.

- The AquaStation™ Chilled + Hot must be used only with the Breville filter supplied or replacement product code LWA063.
- This appliance has been designed specifically for the purpose of filtering and heating drinking quality water only. Under no circumstances should this appliance be used to heat any other liquids.
- Do not place the appliance near the edge of a bench or table during operation. Ensure that the surface is level, clean and free of water and other substances.
- Do not operate the appliance on a sink drain board.
- Do not operate the appliance in an enclosed space, or within a cupboard.
- Never immerse the appliance, power cord or power plug in water, or allow moisture to come into contact with these parts.
- Do not move the appliance while it is switched on.
- Always ensure the appliance returns to standby mode, then turn the power off at the power outlet and remove the power plug from the power outlet before attempting to move the appliance, when the appliance is not in use and before cleaning and storing.
- Do not remove the water tank from the power base during operation.
- If the water tank is removed from the power base during water dispensing, the appliance will automatically stop.
- Always fill the water tank with water between the minimum (MIN) and maximum (MAX) as marked on the water tank.
- Too little water will result in the appliance not operating and 'Fill Tank' will display on the LCD screen. Filling above the maximum mark (MAX) may result in water splashing from the water tank.
- Ensure the water level is always above the MIN level for optimum dispensing flow rate.
- The lid should always be correctly fitted on the water tank except when refilling.
- Do not place the appliance in direct sunlight. Colour fading and discolouration may occur when the appliance is consistently exposed to sunlight.

- Care should be taken when handling the appliance during and after use, ensuring that the appliance's spout and other parts and surface areas are not touched as these may still be hot due to residual heat after hot water dispensing.
- Allow the appliance to cool down before moving or cleaning any parts.
- Use in a well ventilated area. This appliance emits hot steam.
- Condensation from steam may form on the LCD screen and control panel; this is normal.
- Use caution when using the descale feature as hot steam may be released. Before descaling, ensure the drip tray is emptied and repositioned. Refer to 'Decaling' section for instructions.
- This appliance is intended to filter tap water only. Do not put water of unknown quality into the appliance. Use only cold or room temperature water. Do not use for the preparation of baby formula.

- Do not fill the water tank with hot water. Water added to the water tank should not be less than 5°C or more than 40°C. If water in the tank is outside these temperatures, discard and fill with cold tap water.
- Do not leave the appliance unattended during operation.
- Do not remove filter whilst the appliance is operating.
- Surface is subject to residual heat after use.



WARNING

- Keep ventilation openings, in the appliance enclosure or in the built-in structure, clear of obstruction.
- Do not use mechanical devices or other means to accelerate the defrosting process, other than those recommended by the manufacturer.
- Do not damage the refrigerant circuit.
- Do not use electrical appliances inside the food storage compartments of the appliance, unless they are of the type recommended by the manufacturer.
- When positioning the appliance, ensure the supply cord is not trapped or damaged.

- Do not locate multiple portable socket-outlets or portable power supplies at rear of the appliance.
- Do not operate the appliance on an inclined plane. Do not move appliance unless the appliance is turned off and unplugged from the power outlet.
- Keep the appliance and all parts clean. Follow the cleaning instructions provided in this book.
- Any procedure not listed in this instruction book should be performed at an authorised Breville Service Centre.
- Position the appliance at a minimum distance of 20cm away from walls, curtains and other heat or steam sensitive materials and provide adequate space above and on all sides for air circulation.
- Do not let the power cord hang over the edge of a bench or table, touch hot surfaces or become knotted. Keep away from hot gas or electric burners, or where it could touch a heated oven.
- This appliance is for household use only. Do not use this appliance for anything other than its intended use. Do not use in moving vehicles or boats. Do not use outdoors.

IMPORTANT SAFEGUARDS FOR ALL ELECTRICAL APPLIANCES

- Fully unwind the power cord before use.
- Connect only to a 230V or 240V power outlet.
- The appliance must be used on a properly grounded outlet. If you are not sure, please consult a qualified electrician.
- Do not, under any circumstances, modify the power plug or use a power plug adapter.
- Do not place this appliance on or near a heat source, such as a hot plate, oven or heaters.
- **Misuse may cause injury**
- This appliance can be used by children aged from 8 years and above and persons with reduced physical, sensory or mental capabilities or lack of experience and knowledge if they have been given supervision or instruction concerning use of the appliance in a safe way and understand the hazards involved.
- Children should be supervised to ensure that they do not play with the appliance.

- Always turn the appliance to the OFF position, switch off at the power outlet and unplug at the power outlet when the appliance is not in use.
- Before cleaning, always turn the appliance to the OFF position, switch off at the power outlet, unplug at the power outlet and remove the power cord, if detachable, from the appliance and allow all parts to cool.
- To protect against electric shock, do not immerse the power cord, power plug or appliance in water or any other liquid or allow moisture to come in contact with the parts, unless it is recommended in the cleaning instructions.
- Any maintenance other than cleaning should be performed at an authorised Breville Service Centre
- It is recommended to regularly inspect the appliance. To avoid a hazard, do not use the appliance if power cord, power plug or appliance becomes damaged in any way. Return the entire appliance to the nearest authorized Breville Service Centre for examination and/or repair.
- The installation of a residual current device (safety switch) is recommended to provide additional safety protection when using electrical appliances. It is advisable that a safety switch with a rated residual operating current not exceeding 30mA be installed in the electrical circuit supplying the appliance. See a qualified electrician for professional advice.
- During electrical storms, the appliance should be disconnected from the power source at the wall socket to prevent any electrical surges that may arise during the storm and which may inadvertently cause damage to the appliance and its electronic componentry.
- Cleaning and user maintenance shall not be made by children without supervision.

SPECIFIC INSTRUCTIONS FOR WATER FILTER

- Filter cartridge should be kept out of reach of children.
- Store any unused filter cartridges in a dry place sealed in the original packaging.
- Protect filter cartridges from heat and direct sunlight. Only remove from packaging before using.
- Do not use a filter cartridge that is damaged.
- Do not open filter cartridge housing to access the material inside.
- If you are absent for a prolonged period of time, empty and clean the water tank and replace the filter cartridge before next use.
- Refer to the filter installation instructions found in the 'Assembly' section of these instructions.

BREVILLE ASSIST™ PLUG

- Your Breville appliance comes with a unique Assist™ Plug, conveniently designed with a finger hole in the power plug for easy and safe removal from the power outlet. For safety reasons, it is recommended you plug your Breville appliance directly into its own electrical outlet on a dedicated circuit separate from other appliances. If the electric circuit is overloaded with other appliances, your appliance may not function properly. Use in conjunction with a power strip or extension cord is not recommended.

**FOR HOUSEHOLD USE ONLY
SAVE THESE INSTRUCTIONS**



Components

- A. Water tank lid
with easy-grip handle
- B. The Activ360™ 4-Stage Filter
with pull ring for easy removal
- C. Filter holder
- D. Water tanks
Including a removable,
external 6L water tank plus an
internal 2L chilling chamber
(not shown)

NOTE - Total external tank capacity is 6L, however, it is recommended to always fill the external water tank with water between the minimum (MIN- 2L) and maximum (MAX- 5L) as marked on the water tank.

Filling above the maximum mark (MAX-5L) may result in water splashing from the water tank.

- E. LCD screen
- F. Cold button
- G. Function Dial
- H. Cold Favourite button
- I. Start/Stop button
- J. Hot Button
- K. Hot Favourite button
- L. Dispensing spout
- M. Dispensing area with drip tray holder
20cm cup clearance height with tray in place, 23cm height if drip tray removed, 14cm height if hooked to drip tray holder
- N. Detachable magnetic drip tray
Attaches to the base or can be hooked to the tray holder (M)
- O. Removable tray grill for cleaning
- P. Non-marking, non-slip feet

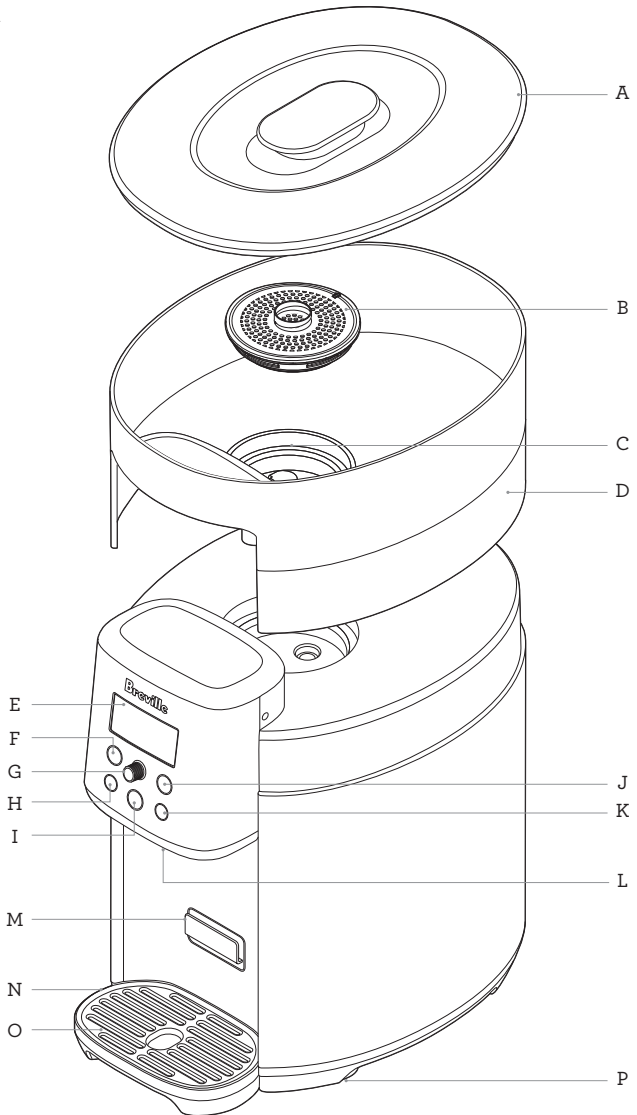

Not Shown

- Breville Assist™ Plug
- Drain Plug & Cap (Located underneath unit)



Control Panel



FUNCTION DIAL/SELECT

Turn/Press FUNCTION dial to adjust/select from the following:

MENU - When using HOT, turn dial to select between pre-programmed menu options and the custom setting; press the dial to confirm selection.

TEMP - when using Custom, turn dial clockwise to increase temp and anti-clockwise to decrease temperature; press the dial to confirm selection.

VOLUME - when using Ambient or Custom, turn dial clockwise to increase volume and anti-clockwise to decrease volume; press the dial to confirm selection.



NOTE

TEMP & VOLUME cannot be adjusted once water dispensing commences.



NOTE

The FUNCTION dial light will illuminate solid white when the unit is switched on at the power (to indicate the unit is operational). The light ring will turn off when water is dispensing or when the unit enters standby mode after 5 minutes of non-use.



START | STOP

START/STOP BUTTON

Press to start or stop dispensing filtered water (ambient, chilled or hot water dispensing). The water droplet light illuminates solid white while dispensing, and will flash if hot water is selected as a reminder that dispensing will not commence until START/STOP is pressed.



HOT



HOT WATER BUTTON

Press once to access the hot water menu. The HOT button light will illuminate and the hot water menu will appear on the LCD screen. The hot beverage menu offers programmed ideal brew temperatures recommended for black, white, green tea, coffee and custom. Custom allows for manual selection of temperature (45-100° Celsius) and volume (100mls to 1.2L).

COLD



COLD WATER BUTTON

Press once to access cold settings. The COLD button light will illuminate and the cold water settings will appear on the LCD screen. The COLD setting allows for manual selection of temperature (5° to 15° Celsius) and volume (100mls to 500mls). The COLD button light will continuously flash when reaching set temperature.



NOTE

The COLD button blue LED light ring will continue to cycle on and off in AMBIENT/ COLD/HOT settings to indicate that the compressor is turning on and off to maintain the correct temperature.

HOT & COLD FAVOURITE BUTTONS

The HOT & COLD FAVOURITE settings allow you to save your most used setting.

At the press of a button, your favourite program can be accessed time after time.

LCD SCREEN PROGRAM TABLE

Function	Water Dispensing Flow Rate per Min	^Preset Temp °C	^Temp Range °C	Temp +/- Increments	Preset Volume MLS	Volume Range MLS	Volume +/- Increments
Cold	1L	5	5 to 15	1°C	250mL-	100-500	from 100-250mL increase by 25mL, from 250-500mL increase by 50mL, from 500mL+ increase by 100mL
Ambient#	1L	Temp of Water inside Water Tank	Temp of Water inside Water Tank	N/A	250mL-	100-500	25mL
Black Tea	400mL	100°C	N/A	N/A	250mL	100-500	25mL
Coffee	400mL	95°C	N/A	N/A	250mL	100-500	25mL
White Tea	400mL	85°C	N/A	N/A	250mL	100-500	25mL
Green Tea	400mL	80°C	N/A	N/A	250mL	100-500	25mL
Custom	400mL	N/A	45-100	5°C	250mL	100-1200	25mL

^Temperature is measured at the heating element and chilling chamber not from the spout.

#Ambient water temperature will vary.

-Without setting volume, unit will automatically stop pouring after 1 minute.



NOTES

- Hot water temperature settings are measured at the heating element, not the dispensed temperature at the spout or in the cup.
- Cold water temperature settings are measured in the chilling chamber, not the dispensed temperature at the spout or in the cup.
- When dispensing ambient water, if START/ STOP is not pressed to stop water flow, dispensing will automatically stop after 60 seconds.
- Ambient water temperature will vary. The temperature dispensed will be influenced by the external factors surrounding the unit itself. An increase in the air temperature will cause water tank temperature to increase as well.
- If the water temperature in the tank becomes too warm, discard and replace with cold tap water. Water temperature in the tank should not be dispensed if above 40°C.

LCD SCREEN DISPLAY MENU

COLD

Appears on the screen only when the COLD button has been selected

HOT

Appears on the screen only when the HOT button has been selected.

CUP VOLUME INDICATOR

Appears on the screen only when volume is being set to visually show the level of water that will be dispensed into the cup.

AMBIENT

Displays on the screen as the default setting when in standby mode and when dispensing ambient filtered water.

FILTER RESET

Appears on the screen as a reminder to change the filter cartridge once the filter life timer has counted down.

DESCALE

Appears on the screen every 6 months as a reminder to descale to keep the unit working to its optimum performance.



NOTE

To descale more frequently than the programmed descale reminders, press and hold the HOT button for 3 seconds until Descale appears on the screen.

To quit descale mode, press and hold the HOT button again for 3 seconds.

FILL TANK

Appears on the screen when the water tank level is low. The unit will not dispense water until the tank is refilled.

The unit will beep 3 times and FILL TANK will flash on the LCD screen. The water droplet light on the START/STOP button illuminate solid red to alert the user that the water tank needs to be filled.

Once the tank has been filled, FILL TANK will no longer illuminate on the LCD screen.



NOTE

Take care when removing the water tank from the base after use as residual water may drip.



NOTE

The unit will not dispense any water while the tank is below the minimum water level. Ensure the water level is always above the MIN level for optimum flow rate.

TEMP (°C) CONTROL & VOLUME (MLS)

When CUSTOM menu is selected, the temperature (between 45°C-100°C) and the volume of water dispensed (between 100mL-1.2L) can be manually adjusted.

For AMBIENT, only the volume of water can be manually adjusted (between 100-500ml).

COLD SETTING

Press COLD button to enter the cold setting. Turn the FUNCTION dial to set the temperature (between 5°C-15°C) and the volume of water dispensed (between 100mL-500mL) can be manually adjusted. then press the FUNCTION dial to select.

HOT BEVERAGE MENU

Press the HOT button to enter programmed MENU.

Turn the FUNCTION dial to navigate the menu, then press the FUNCTION dial to select.

HOT & COLD FAVOURITES

COLD or **HOT** favourites icon  appears on the screen when a COLD or HOT FAVOURITE button has been selected.



Features

WHAT IS THE AQUASTATION™ CHILLED + HOT?

The Breville AquaStation™ Chilled + Hot, when used with the Activ360™ 4-stage fast flow water filtration system, provides cleaner, great-tasting Ambient, Chilled or Hot filtered water on demand.

The Activ360™ Filter, with 4 distinct levels of filtration, removes contaminants from water that can cause bad taste and odour, which may potentially be harmful to your health.

- 1. Stage 1- Pre-Sediment Mesh Filter**
Filters microplastics and floating particles
- 2. Stage 2- Ion-Exchange Resin Filter**
Filters limescale and metals
- 3. Stage 3- Activated Carbon Filter**
Filters Pesticides and Chlorine
- 4. Stage 4- Post Filter**
Filters fine particles

**4-stage fast flow filtration tested and/or certified to remove/reduce microplastics, floating particles/sediment, pesticides, chlorine, limescale & heavy metals.*

For more information, visit Breville.com

No Plumber Required

The unit will start to work as soon as assembled, water is added and the power cord is connected to a power source; then simply press to dispense filtered water. No need to plumb into mains water.

Filter Life Counter

The unit reminds you to replace the filter every 90 days or approximately 200L of water*, whichever comes first, to ensure the best filtration performance.

You may choose to change your filter more frequently in areas with poor water quality.

**The filter change alert is set at 90 days or approximately 200L of water, whichever comes first, with performance based on typical municipal drinking water quality, however, water quality may vary considerably from one area to the next which may affect the life of the water filter and more frequent replacement may be required.*

Filter Reset Replacement Alert

FILTER RESET will flash on the screen to indicate when it is time to change the filter. Once the filter is replaced, reset the filter time to reset the filter life countdown.

Last Setting Memory

The unit will return to the last used default hot beverage menu selected unless turned off at the power outlet.

CUSTOM setting will return to the last set temp and volume unless the power is turned off.

Removable, Magnetic Drip Tray + Drip Tray Holder

The drip tray can easily be removed or hooked to the drip tray holder to accommodate different sizes of cups, glasses or reusable bottles. The magnetic edge helps to keep the tray in place when attached at the base. Empty regularly to avoid overspill.

Water Level Sensor

The water tank is equipped with a floating sensor to detect water levels and will automatically stop dispensing when the water level becomes too low. Fill Tank will appear on the display screen.

Altitude Sensor

The unit is equipped with an altitude sensor to detect local boiling points and will automatically regulate the boiling point to avoid steam issues at high-altitude areas.

One-way Tank Valve

The water tank has been designed with a one-way valve so that it can be removed from the unit even if water is still in the tank. This prevents the water from leaking when removed from the dispensing unit. Be mindful however that there may be some residual water droplets when removed.

BPA Free*

All parts that come into direct contact with water are made from BPA Free* materials

** Breville makes its BPA Free claim for this product based on independent laboratory testing performed for all the food contact plastic materials of the product per EU Commission regulation No 10/2011. BPA Free Material is used in all parts that come into contact with food.*

WATER QUALITY

As far as contained in tap water, the contaminants or other substances reduced by the Activ360™ water filter are not necessarily in all users' water. Tap water may contain impurities and heavy metals such as lead, copper, chlorine, limescale, pesticides and other contaminants like microplastics which all lead to impaired taste.



CAUTION

Do not use with water that is microbiologically unsafe or with water of unknown quality without adequate disinfection before or after the system. This product should only be used with water that has been adequately chlorinated or disinfected. For use with *municipal cold water only.*



Assembly

BEFORE FIRST USE

- Remove and safely discard any packaging material or promotional labels attached to your unit and filter. Check for any missing or damaged parts as per the components list.



NOTE

As an important part of our quality control process, your unit has been individually tested. As a result, you may notice a small amount of condensation or water droplets on the inside of the water tank. There is no need for concern. Please remove and discard the protective red silicone rubber cap from the spout before use.

- Remove the Activ360™ 4-Stage filter from the water tank and set aside.
- Do not wash the filter or insert into the water tank until 'Flushing the Breville AquaStation' and 'Preparing the Activ360 Filter' instructions are completed as found in this book.
- Place the unit on a dry, flat level surface.
- Wash the water tank lid, water tank in warm soapy water with a soft, non-abrasive cloth. Rinse and dry thoroughly with a clean, soft, lint-free cloth before returning to the unit.
- Assemble the water tank back onto the power base.
- Plug the power plug into a 230/240V power outlet and turn on the power outlet.



IMPORTANT

When moving the unit always lift from the base using two hands and set down gently on a flat and level surface.

FLUSHING THE BREVILLE AQUASTATION

It is important to flush and rinse the dispensing system before using the unit for the first time. Before first use, it is recommended to carry out the below steps **without** the Activ360™ Water Filter in place.

1. Fit only the water tank into place with the lid removed.
2. Fill the tank with cold tap water to the MAX level. Never fill past the MAX level.
3. Place a 1L container under the dispensing spout.
4. Press the START/STOP button once to start dispensing ambient water until the container is full, then press the START/STOP button once again to stop dispensing. Discard the collected water.
5. Repeat steps 3-5 until all the water in the tank has been dispensed. Water dispensing will stop dispensing when the water level is too low or automatically after 60 seconds.
6. Proceed to the next step, 'Preparing the Activ360™ Filter'.

PREPARING THE ACTIV360™ FILTER

Flushing the filter is required every time you insert a new filter cartridge.

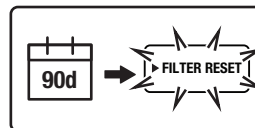

Filter Reset will flash continuously on the screen to notify after 90 days or 200L of water filtered as an alert that it is time to replace the filter cartridge.

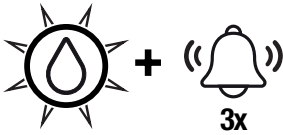

3 beeps will sound and the water droplet on the STOP/START button will flash red continuously.

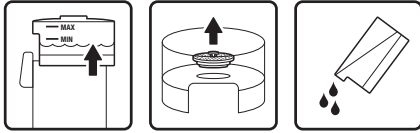

1. Lift the water tank from the unit, remove the lid and set aside. Lifting by the ring, remove the filter cartridge from the filter holder and discard any remaining water inside the water tank.



2. Remove the new filter cartridge from its packaging.



It is normal for the filter to appear moist when removed from its wrapping. This is condensation from the hygienic steam sterilisation process.

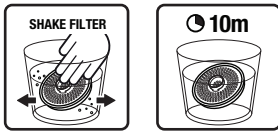

3. Immerse the filter in a bowl of tap water and gently shake until there are no air bubbles. Soak filter in the tap water for 10 minutes.

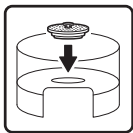

4. Once soaked, insert the filter into the filter holder and push down firmly to secure in place.



Make sure the filter is tightly fitted.

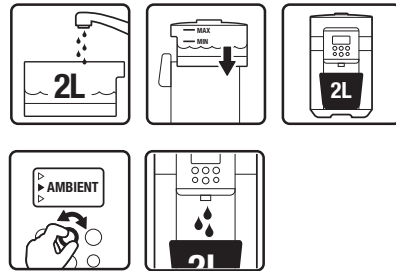

5. To flush and activate the new filter cartridge, add 2L of water to the water tank and return to the unit. Place a 2L empty container under the spout. Turn the FUNCTION dial until the indicator reaches AMBIENT, then press the FUNCTION dial to select. Press START/STOP button again to start dispensing water into the container.



6. Fill the container to full, then discard the collected water.

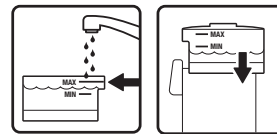

7. Once all the water in the water tank has been flushed, fill the water tank with tap water up to the MAX line and return the tank to the unit.

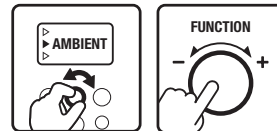

8. Turn the FUNCTION dial until the indicator reaches FILTER RESET, then press the FUNCTION dial once to reset the filter counter. FILTER RESET will no longer appear on the screen.
9. The unit is now ready to use.

 **NOTE**

When preparing the Activ360™ filter for the first time use of your AquaStation™, there is no need to action step 8 for filter reset; once the filter is installed, the unit will automatically begin the filter life counter.

 **IMPORTANT**

- A dirty filter may reduce the performance of the unit
- The filter is not washable.
- Use only the original Breville filter specifically intended for use with the AquaStation unit
- Filter replacement alert is set to 90 days or approximately 200L of water, whichever comes first, however, for higher-than-normal consumption or poor water quality, more frequent changing may be required. If you need to change your filter before the filter replacement alert activates at 90 days or approximately 200L, press and hold the FUNCTION dial for 3 seconds, FILTER RESET will flash on the screen, press the FUNCTION dial once to reset the filter time once you have changed the filter cartridge.

 **NOTE**

To exit FILTER RESET mode without resetting the filter, press and hold the FUNCTION dial for 3 seconds.

- Water quality varies considerably from one area to the next and has an effect on the life of the water filter cartridge. For optimum performance, the filter change alert will activate after 90 days.

 **NOTE**

- No filter or an incorrectly fitted filter may cause the unit to operate less effectively and/or may cause damage to the unit.
- The filter must be fitted in the filter holder with the pull ring facing upwards.
- From time to time, small floating black particles may escape from the filter into the water. This is a natural carbon fibre which is food grade safe and not harmful to health.

 **NOTE**

For replacement water filters, visit Breville.com or contact Breville Customer Service.



Operation

OPERATING YOUR AQUASTATION CHILLED + HOT

1. Ensure the water tank is in place and that the water filter cartridge is correctly fitted into position.
2. Plug into a 230/240V power outlet. The unit will beep, the water droplet light will flash 3 times, the LCD screen will illuminate, and AMBIENT will display on the LCD screen to indicate the unit is in standby mode.
3. Remove the water tank and fill with cold tap water to the MAX level. Never fill past the MAX level.
4. Ensure the water tank is assembled to the unit correctly and place a cup of choice onto the drip tray, or alternatively, remove the drip tray to accommodate large glasses.



NOTE

Always ensure the water tanks are filled to the MAX level for optimum flow of water from the spout. Ensure the water tanks are filled above MIN water level, or as soon as the FILL TANK alert appears on the LCD display.

If the water level falls below the MIN tank marking, the water sensor will automatically stop dispensing and FILL TANK will appear on the screen.

Regularly check and discard any water that might accumulate in the drip tray.

TURNING OFF THE AQUASTATION

Turn off at the power outlet.



IMPORTANT

Turning the unit off at the power outlet will delete the 'last setting' memory function.



NOTE

Discard any filtered water that has been left sitting for several days or more. This will ensure you have cleaner, great-tasting water. If your filter has been unused for a long period of time, it is recommended to resoak the filter for 10 minutes before use and clean the water tanks as per the cleaning instructions found in this book.



IMPORTANT

To prevent damage to the compressor and to ensure maximum performance, place unit in an upright position for 12 hours after transit.



NOTE

During the first-time usage only, when pouring hot water, the first cup dispensed will be cold water for boil dry protection and unit longevity purposes. Discard the first cup of water poured. Every time the power source is switched on and off, the boil-dry protection is reset.

STANDBY MODE

When the unit is plugged into the power outlet, the water droplet light will flash 3 times, the display screen will illuminate and AMBIENT will appear on the display screen to indicate the unit is ready for use.

The unit will automatically enter energy-saving standby mode after 5 minutes if not used after first cooling cycle. The water droplet light will turn off when in standby mode.

To awaken the unit press any button or press/turn the FUNCTION dial once; one long beep will sound, the water droplet light will illuminate white and flash rapidly 3 times to indicate that the unit is ready to use.

Ambient Water in Operation

- Without setting volume

1. Press the START/STOP button to instantly dispense filtered ambient water. Press START/STOP button once more to stop dispensing water.



NOTE

If the START/STOP button is not pressed a second time to stop, dispensing will automatically stop after 60 seconds.



NOTE

Always ensure the correct sized cup/glass is placed under the spout to collect the selected volume of dispensed water.

Ambient Water in Operation

- When setting volume

1. Rotate the FUNCTION dial clockwise/anticlockwise for the default volume to appear on the LCD screen; the 250ml default volume will flash on the screen. Rotate the FUNCTION dial clockwise or anticlockwise to adjust the volume, then press the FUNCTION dial to confirm the selection. The volume icon indicator  will appear on the LCD screen to visually show you the amount you are about to dispense
2. Press START/STOP button once to start dispensing filtered ambient water at the set volume. AMBIENT will flash on the LCD screen, the water droplet light will illuminate white to indicate water is dispensing, and the FUNCTION dial light will turn off.
3. Water will automatically stop dispensing once the set volume has been reached and the water droplet light will turn off. The unit will return to standby mode.

COLD Water in Operation

- Without setting volume

1. Press the COLD button once, the blue LED light ring will illuminate around the COLD button, COLD and 5°C default cold temp will appear on the display screen.

2. Press the FUNCTION dial to confirm selection; the blue LED light ring around COLD button will start to flash to indicate that the water is reaching the default cold temperature 5°C.
3. Once the water unit has reached the default temperature, the blue LED light will stop flashing and will illuminate solid blue to indicate that the water dispenser is now ready to dispense filtered chilled water at the set temperature.
4. Press START/STOP button once; the unit will start dispensing filtered chilled water, the word COLD will flash on the LCD screen, and the water droplet icon will illuminate white to indicate water is dispensing.



NOTE

START/STOP button can be pressed to dispense water before the unit reaches the set temperature, however, the water dispensed will not be at the set temperature.

5. Once the desired amount of water has been dispensed, press START/STOP button again to stop dispensing; the white LED light water droplet icon will no longer illuminate and the unit will return to standby mode.



NOTE

If the START/STOP button is not pressed a second time to stop, dispensing will automatically stop after 60 seconds.



NOTE

Always ensure the correct sized cup/glass is placed under the spout to collect the selected volume of dispensed water

Cold Water in Operation

- When setting volume

1. Press the COLD water button once; the blue light around the COLD button will illuminate and COLD will display on the screen. Rotate the FUNCTION dial clockwise/anticlockwise for the default temperature to appear on the LCD screen; the 5°C default temperature will

flash on the screen. Rotate the FUNCTION dial clockwise or anticlockwise to adjust the temperature between 5°C to 15°C, then press the FUNCTION dial to confirm the selection.

2. The 250ml default volume will now flash on the screen. Rotate the FUNCTION dial clockwise or anticlockwise to adjust the volume, then press the FUNCTION dial to confirm the selection. The volume icon indicator  will appear on the LCD screen to visually show you the amount you are about to dispense.
3. Press START/STOP button once, COLD will flash on the LCD screen, the blue LED light ring will flash continuously to indicate that the water in the chilling chamber is not at the set temperature.
4. Once the correct temperature has been reached, the COLD button light will stop flashing and illuminate solid blue indicating that the water dispenser is now ready to dispense filtered chilled water at the set temperature and volume.
5. Press START/STOP button once again to start dispensing filtered COLD water at the set volume. COLD will continue flashing on the LCD screen, the water droplet light will illuminate white to indicate water is dispensing, and the FUNCTION dial light will turn off.
6. Water will automatically stop dispensing once the set volume has been reached and the water droplet light will turn off. The unit will return to standby mode.

ECO MODE

To put the unit in eco mode, in any setting, press and hold the COLD button for 5 seconds to deactivate the compressor, the COLD light ring will turn off and the unit will sound a long beep. The hot and ambient function can still be used. Press the COLD button once to activate exit eco mode.

Hot Menu - Black Tea, Coffee, White Tea & Green Tea

1. Press the HOT water button once; the red light around the HOT button will illuminate and HOT will display on the screen. The hot beverage programmed menu will appear on the screen with the indicator beside the first menu option. The default temp and volume will appear on the LCD screen.



NOTE

The water droplet white light will flash until START/STOP is pressed to start dispensing.

2. Turn the FUNCTION dial to scroll through the pre-set menu options. The top digits on the LCD screen indicate the hot water temperature and the bottom digits indicate the volume of water to be dispensed.
3. Press START/STOP button once to dispense at the default volume (250ml), or to adjust volume, press the FUNCTION dial once. The Volume digits on the LCD screen will begin to flash. Rotate the FUNCTION dial clockwise or anticlockwise to adjust the volume, then press the FUNCTION dial to confirm the selection.
4. Press START/STOP button once to begin dispensing the filtered hot water at the set temp and volume. The red light around the HOT button will remain on, the selected menu option and the word HOT will flash on the LCD screen. The water droplet white light will illuminate solid while water is dispensing.
5. Water will automatically stop dispensing once the set volume has been reached. The red light around the HOT button and the water droplet light will both turn off. The unit will return to standby mode.



NOTE

This appliance is not calibrated for commercial or scientific use. Temperatures may vary by +/-2°C, which is within range for optimal brewing for each tea menu. Hot temperatures are indicative of temperature at the heating element, not at the spout or in the cup.



NOTE

The appliance is calibrated at sea level hot water temperatures. High altitude locations will have an impact on hot water temperatures due to low atmospheric pressure.

Hot Menu - Custom

This setting allows for customising of temp and volume to suit any hot beverages.

1. Press the HOT water button once; the red LED light ring will illuminate with the indicator beside the first pre-set hot beverage menu with the default temp and volume will appear on the LCD screen.



NOTE

The water droplet white light will flash until START/STOP is pressed to start dispensing.

2. Turn the FUNCTION dial until the indicator on the pre-set hot beverage menu reaches CUSTOM. Press the FUNCTION dial to confirm selection.
3. When the Temp digits on the LCD screen begin to flash, rotate the FUNCTION dial clockwise or anticlockwise to adjust the temperature between 45-100°C. Press the FUNCTION dial to confirm the selection.
4. When the Volume digits on the LCD screen begin to flash, rotate the FUNCTION dial clockwise or anticlockwise to adjust the volume between 100mL-500mL. Press the FUNCTION dial to confirm the selection.
5. Press START/STOP button once to start dispensing the filtered hot water at the customised temperature and volume. The red light around the HOT button will remain on, the selected menu option and the word HOT will flash on the LCD screen. The water droplet white light will illuminate solid while water is dispensing.
6. Water will automatically stop dispensing once the set volume has been reached. The red light around the HOT button and the water droplet light will both turn off. The unit will return to standby mode.



NOTE

- The unit will return to the last custom setting used.
- To change your CUSTOM setting at any time, repeat steps 1-4 above.
- If the unit is disconnected from the power, the CUSTOM memory will reset to the default setting.

HOT & COLD FAVOURITE SETTING

The HOT & COLD FAVOURITE setting allows you to save one of your most used and favourite COLD and HOT beverage settings.

At the press of a button, your favourite program can be accessed time after time.

Saving Favourite COLD setting

1. Press the COLD FAVOURITE button once; the blue LED light ring will illuminate around COLD button and COLD, 5°C & 250ml will appear on the LCD display while the FAVOURITE symbol ♥ will flash on the LCD display to indicate the favourite setting is in progress.
2. The Temp digits on the LCD screen will start to flash. Rotate the FUNCTION dial clockwise/anticlockwise to adjust the temperature between 5°C to 15°C, then press the FUNCTION dial to confirm the selection.
3. The Volume digits on the LCD screen will start to flash. Rotate the FUNCTION dial clockwise/anticlockwise to adjust the volume. The volume icon will appear to indicate the volume that is about to be dispensed. Press the FUNCTION dial to confirm the volume.
4. To save your COLD FAVOURITE setting, press the COLD FAVOURITE button. The FAVOURITE symbol ♥ will appear on the LCD screen to indicate that the favourite setting has been saved.

5. To use the saved COLD FAVOURITE setting, press COLD FAVOURITE button, then press START/STOP button once. The blue LED light ring around the COLD button will start to flash if the water is reaching the set temperature. Once the machine has reached the set temperature, the light will illuminate solid blue indicating the unit is now ready to dispense filtered chilled water at the set temperature and volume.
6. Press START/STOP button to start dispensing filtered cold water at the set temp and volume; the word COLD will start to flash on the LCD screen, and the water droplet icon will illuminate white to indicate water is dispensing.
7. Water will automatically stop dispensing once the set volume has been dispensed. Both the blue LED light ring and the water droplet icon will no longer illuminate and the unit will return to standby mode.
8. To set a new COLD FAVOURITE setting, press and hold the favourite button for 3 seconds to reset and follow steps 1-4.



NOTE

START/STOP button can be pressed to dispense water before the unit reaches the set temperature, however, the water dispensed will not be at the set temperature.

Saving Favourite HOT setting

1. Press HOT FAVOURITE button once. The red LED light ring will illuminate around HOT button and HOT, 55°C & 250ml will appear on the LCD display and the FAVOURITE symbol ♥ will flash on the LCD display to indicate the favourite setting is in progress.
2. The Temp digits on the LCD screen will start to flash. Rotate the FUNCTION dial clockwise/anticlockwise to adjust the temperature between 45°C to 100°C, then press the FUNCTION dial to confirm the selection.
3. The Volume digits on the LCD screen will start to flash. Rotate the FUNCTION dial clockwise/anticlockwise to adjust the volume.
4. The volume icon will appear on the screen to indicate the volume to be dispensed. Press the FUNCTION dial to confirm the volume.
5. To save your HOT FAVOURITE selection, press the HOT FAVOURITE button. The FAVOURITE symbol ♥ will be displayed on the LCD screen to indicate that the favourite setting has been saved.
6. To use the saved HOT FAVOURITE setting, press HOT FAVOURITE button, then press START/STOP button once. The red LED light ring will illuminate around HOT button, the word HOT will start to flash on the LCD screen, and the water droplet icon will illuminate white to indicate water is dispensing.
7. Water will automatically stop once the set volume has been dispensed. Both the red LED light ring around HOT button and the water droplet icon will no longer illuminate, and the unit will return to standby mode.
8. To set a new HOT FAVOURITE setting, press and hold the favourite button for 3 seconds to reset and follow steps 1-4.



NOTE

When both the “HOT” and “COLD” favourites are set, the FAVOURITES symbol ♥ will appear on the screen.



Tea Insights

TEA TYPES

There are four main types of tea from the tea plant *camellia sinensis*. The picking and processing methods determine the type of tea finally produced.

Black Tea

Black tea is the most common type of tea worldwide. It is made by fermenting the harvested leaves for a couple of hours before heating or drying. This oxidation darkens the leaves and increases the amount of caffeine. Of all the teas, black tea has the strongest colour and flavour.

White Tea

White tea is the rarest and the most exclusive tea. White tea consists of the whitish buds of the tea plant which are steamed then left to dry naturally. This tea is low in caffeine and has a slightly sweet flavour.

Green Tea

Green tea makes up approximately ten percent of the world's tea. The leaves are picked, rolled and dried before they can go brown. Green tea has a distinctive aroma and has a slight astringent taste.

Oolong Tea

Oolong Tea is semi fermented, which means leaves are processed immediately after picking. They only have a short period of oxidation which turns the leaves from green to red/brown. Its leaves have a floral, fruity quality and hence have a delicate fruity taste. It is recommended not to drink Oolong tea with milk, sugar or lemon.

Herbal Infusions or Tisanes

Herbal infused teas are not produced from the tea plant, but from flowers, leaves, roots or seeds. Common herbal beverages are chamomile, peppermint, fennel, rose hip, and lemon verbena.

Herbal infusions that do not contain tea will generally not become bitter with extended brews. These can often be brewed with boiling water 3 times without jeopardising the taste.

Blends

Tea producers make blends by combining different types of teas, often in order to achieve flavour consistency from one season to the next. Common black tea blends include English Breakfast, Earl Grey, Irish Breakfast, and Russian Caravan.

Brewed tea leaves make an ideal garden fertilizer and help condition the soil.

TEA STORAGE

- Teas stored inside a vacuum sealed bag can be stored for up to two years, depending on the quality and grade of tea. Once opened, tea should be stored in an airtight container and kept in a dry and dark place.
- Once opened, black teas will last longer than green and oolong teas, but all tea needs to be stored in ideal conditions.
- You can tell when tea is past its best if it has lost its aroma and will create either a bitter or dull tasting cup.

TIPS FOR OPTIMAL TEA BREWING

- Water quality affects taste. For best results use filtered water.
- Finer tea particles and leaves will infuse more quickly than whole leaves. As a result, finer tea particles often release too much tannin too quickly, creating a harsher taste. Adjust the brewing time until desired strength is achieved.

Suggested Water to Tea Ratio

CUPS / mL	Tea (Teaspoons)
Approx. 2 Cups/500mL	2 tsp
Approx. 3 Cups/750mL	3 tsp
Approx. 4 Cups/1000mL	4 tsp
Approx. 5 Cups/1200mL	5 tsp



Descaling

After regular use, hard water can cause mineral build up in and on many of the inner functioning components, reducing the water flow, water temperature, power of the unit and the taste of the water.

For safe and efficient operation of your unit it is important to descale regularly.

Breville recommends conducting a descaling cycle no longer than 6 month intervals.

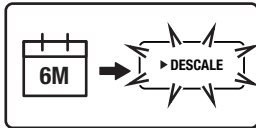

To assist, every 6 months, the LCD screen will display a DESCALE alert.

Descaling is a 3 step process. Once the descale cycle is complete, 2 rinse cycles will follow. DESCALE will flash on the LCD screen during the entire process.

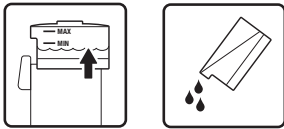

1. To descale, remove the water tanks from the base and remove the filter. Discard any remaining water in the water tank.

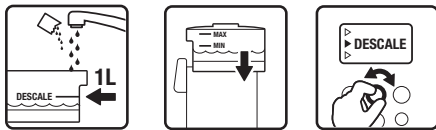

2. Place 100mLs of Breville descale solution into the water tank and fill with tap water to the marked DESCALE line (1L). Reassemble the water tank to the base. Turn the FUNCTION dial until the indicator reaches DESCALE.

**Descaling solutions sold separately.*

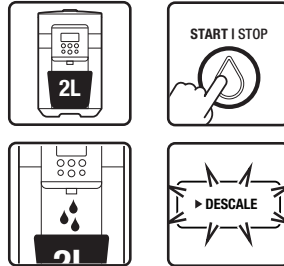

3. Remove the drip tray and place a 2L container under the spout. Press FUNCTION dial to start the descaling cycle. DESCALE on the LCD screen will begin to flash.

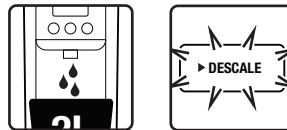

4. Descaling is a 3 step process. Once the descale cycle is complete, 2 rinse cycles will follow. DESCALE will flash on the LCD screen during the entire process. During descaling, the 1L of water with added solution will dispense from the tank automatically. DESCALE will flash on the LCD screen.

NOTE

Following the descaling solution, 1 will appear on the LCD screen indicating 1st rinse cycle.



5. Empty the 1L collection container and discard any remaining descale solution from the water tank. Fill water tank with tap water to the MAX line.

NOTE

Descaling water is not safe for plants, the descale solution is citric acid, Citric acid is below 4.0, meaning that it is acidic and potentially corrosive. Therefore, applying enough citric acid to a plant's water or soil will create an environment unsuitable for the plant.

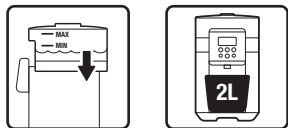

6. Return water tank back to the base and place the 2L container under the spout.

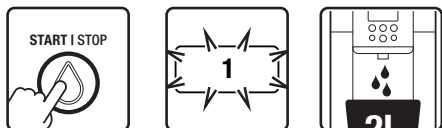

7. Press the FUNCTION dial to start 1st rinse. 1 on the LCD screen will begin to flash to indicate that the 1st cycle is in progress. The water will automatically dispense.



8. Once the 1st rinse cycle is complete, the unit will sound a long beep and 2 will appear on the LCD screen. The word DESCALE will continue to flash on the LCD screen.
9. Empty the Changes: 2L collection container and then replace under the spout. Fill water tank with tap water to the MAX line. Press the FUNCTION dial once to start the 2nd rinse cycle. 2 will appear on the LCD screen to indicate that the 2nd cycle is in progress.

NOTE

The unit will automatically pause after dispensing 2L of water. Empty the 2L collection container and replace under the spout. Press FUNCTION dial once more to continue the 2nd rinse cycle.

10. The unit will automatically pause after dispensing 2L of water. Empty the 2L collection container and replace under the spout. Press FUNCTION dial once more to continue the 2nd rinse cycle.
11. Empty the 2L collection container and then replace under the spout. **Return the filter into filter holder.** Fill water tank with tap water to the MAX line. Press the FUNCTION dial once to start the 3rd rinse cycle. 3 will appear on the LCD screen to indicate that the 3rd cycle is in progress.

NOTE

The unit will automatically pause after dispensing 2L of water. Empty the 2L collection container and replace under the spout. Press FUNCTION dial once more to continue the 3rd rinse cycle.

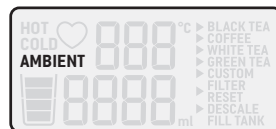

12. The unit will automatically stop rinsing and will sound a long beep once a sufficient amount of water has been dispensed. The unit will enter standby mode and DESCALE will no longer appear on the LCD screen.
13. Remove and clean the drip tray and water tank.

NOTE

- If descaling is required more regularly than when the auto DESCALE alert appears on the screen, press and hold the HOT button for 3 seconds for the word 'DESCALE' to appear on the screen, then follow descale steps 1-13.
- DO NOT turn off the power during descaling
- The descale process cannot be cancelled until it is finished

NOTE

Breville recommend using the Breville Eco Liquid Descaler™

visit Breville.com or contact Breville Customer Service to order.



Care, Cleaning & Storage



CAUTION

To prevent damage to the appliance, do not use alkaline or abrasive cleaning agents, steel wool or scouring pads as these can damage the surface of the unit. Do not place any part of this appliance in the dishwasher.

CLEANING THE AQUASTATION

1. Remove the plug from the power outlet before cleaning.
2. Discard any water in the water tank, then remove the filter cartridge from the filter holder.
3. Wipe the water tanks with a clean, damp, lint-free cloth. The filter is not washable.

CLEANING THE OUTER HOUSING

- Wipe with a soft, damp cloth followed by a soft, dry cloth to polish.
- Alternatively, purchase a stainless steel cleaner such as Breville's Stainless Steel Cleaner & Polish and follow directions.
- Do not use abrasive cleansers, pads or cloths which can scratch the surface.



NOTE

For Breville's Stainless Steel Cleaner & Polish, visit Breville.com or contact Breville Customer Service.

CLEANING THE WATER SPOUT

Residue build-up or foreign substances, such as dust or lint, may accumulate in the water outlet. Clean the spout periodically using a soft brush (not included).

EMPTYING THE INTERNAL 2L CHILLING CHAMBER

1. To completely empty the internal 2L chilling chamber before storing, turn off and unplug the unit from the power outlet.
2. Remove and empty the removable external 6L water tank.
3. Place the unit on sink drain board ensuring the power cord & power plug are not immersed in any water, unscrew the plastic drain plug cap (refer to figure a) located underneath the unit, then pull out the rubber plug (refer to figure b), allow water to drain from the internal 2L chilling chamber.

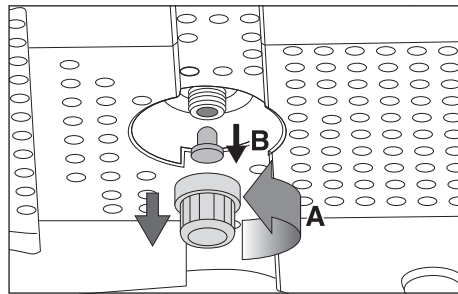

4. Replace the rubber plug (refer to figure c) and screw the plastic drain plug cap back on (refer to figure d).

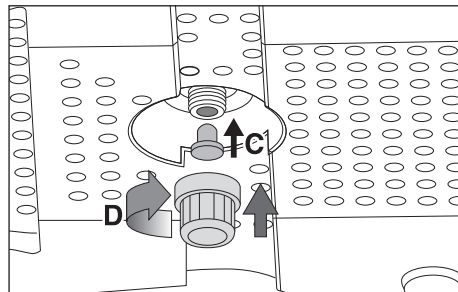

5. Wipe the water the base of the unit with a clean, dry, lint-free cloth.

CLEANING THE DRIP TRAY

The drip tray should be removed, emptied and cleaned after each use. Empty the tray before removing the top grill and cleaning.

1. Remove the drip tray from the unit and discard any water.
2. Separate the top grill from the drip tray.
3. Wash the drip tray and grill in warm soapy water and dry thoroughly.
4. Place the grill back onto the drip tray then push the assembled drip tray back into position in front of the unit using the magnetic connection.



WARNING

To protect against electric shock, do not immerse cord, plug or unit in water or any other liquid or allow moisture to come into contact with these parts.

STORAGE

Remove the plug from the power outlet. Follow the 'Care & Cleaning' instructions, ensuring the unit is completely empty, clean and dry before storing. Stand the unit upright. Do not store anything on top. If stored for a long period, we recommend following the 'Flushing the AquaStation™' and 'Preparing the Activ360 Filter' instructions found in this book before using the unit again.



WARNING

The water dispenser contains a compressor that **MUST** remain upright at all times. Do not store the water unit on any other surface apart from its feet.

ERROR MODE

If your unit displays Er on the LCD Screen, contact Breville Customer Service. See Troubleshooting for more details.



Troubleshooting

PROBLEM/Error Code Displayed on Screen	POSSIBLE CAUSE	WHAT TO DO
When the water tank is filled, neither cold nor hot water comes out.	<ul style="list-style-type: none">• Uneven placement and tilt of the water tank	<ul style="list-style-type: none">• Make sure the water tank is full and pushed down to ensure good installation.• If the dispensing problem persists, contact Breville Customer Service.
Slow water flow rate	<ul style="list-style-type: none">• Aging of pump or inlet at the base of the unit is clogged	<ul style="list-style-type: none">• Contact Breville Customer Service
Small amounts of black particles in water tank	<ul style="list-style-type: none">• These are small pieces of carbon from the filter. These carbon particles are food grade and are not harmful. They will not impair the performance of your filter or unit.	<ul style="list-style-type: none">• Flush your water unit and water filter cartridge. Refer to 'Flushing the Breville AQUASTATION™' (page 12) and 'Preparing the Activ360 Filter' (page 12) NOTE: Some carbon fibre residual may still be present after flushing the water unit and filter.
START/STOP Button does not respond	<ul style="list-style-type: none">• The unit is not connected to the power	<ul style="list-style-type: none">• Plug in to a usable power outlet and turn power on.
Leakage from water tank	<ul style="list-style-type: none">• The water tank is filled beyond the maximum water level• Tank is not firmly pushed into position	<ul style="list-style-type: none">• Ensure water is only up to the MAX water level marking. If leakage continues, please contact Breville Customer Service• Replace the water tank, pressing down to ensure that it is properly positioned and attached to the unit
Odd taste of the water	<ul style="list-style-type: none">• The filtered water is not used for a long time• The filter has reached end of life	<ul style="list-style-type: none">• Discard the remaining water in the water tank and refill with fresh tap water. Depending on the length of time, the filter may require flushing again.• Replace with new filter
"FILTER RESET" flashing on LCD screen.	<ul style="list-style-type: none">• Filter needs to be changed or filter reset has not been actioned	<ul style="list-style-type: none">• Change the filter if required, turn the FUNCTION dial until the indicator on the LCD screen reaches the FILTER RESET function and press ADJUST/SET button once to reset.
LO	<ul style="list-style-type: none">• Water temperature in water tank less than 5 °C	<ul style="list-style-type: none">• Fill water between 5 °C to 40 °C
HI	<ul style="list-style-type: none">• Water temperature in water tank is higher than 40 °C	<ul style="list-style-type: none">• Fill water between 5 °C to 40 °C



Troubleshooting

PROBLEM/Error Code Displayed on Screen	POSSIBLE CAUSE	WHAT TO DO
E03	<ul style="list-style-type: none">• Protection against power supply fluctuations• Heating element malfunction	<ul style="list-style-type: none">• To clear the error message, turn the power off at the power outlet and unplug the unit. Reconnect the unit to a power outlet and turn the power on.• If the dispensing problem persists, contact Breville Customer Service.
E04	<ul style="list-style-type: none">• Dry boil protection	<ul style="list-style-type: none">• Turn the unit off at the power and Contact Breville Customer Service
E05	<ul style="list-style-type: none">• Cooling Tank NTC open or short	<ul style="list-style-type: none">• Contact Breville Customer Service
E06	<ul style="list-style-type: none">• Altitude Sensor Failure	<ul style="list-style-type: none">• You can continue to use the appliance, however, contact Breville Customer Service as a change in altitude will impact performance.

If you cannot remedy problems by using the troubleshooting chart above, contact Breville Customer Service.



Notes

Breville Customer Service Centre

Australian Customers

Phone: 1300 139 798

Web: www.breville.com

New Zealand Customers

Phone: 0800 273 845

Web: www.breville.com

Breville®

Master Every Moment™

Breville, the Breville logo, AquaStation and Activ360 are trademarks of Breville Pty Ltd. All other brands may be trademarks of their respective owners. Breville's products are distributed in New Zealand under licence A.B.N. 98 000 092 928.

Approved by the appropriate electrical supply authorities.
Made in China to our specifications.

Due to continued product improvement, the product illustrated on this carton may vary slightly from the actual product.

LWA600 H23