

Operating instructions Dishwasher



To avoid the risk of accidents or damage to the appliance, it is **essential** to read these instructions as well as the installation plan before it is installed and used for the first time.

Contents

| | |
|--|----|
| Warning and Safety instructions | 5 |
| Notes on the operating instructions | 15 |
| Notes on the layout | 15 |
| Items supplied | 16 |
| Guide to the appliance | 17 |
| Appliance overview | 17 |
| Control panel | 18 |
| Caring for the environment | 19 |
| Using for the first time | 20 |
| Opening the door | 20 |
| Closing the door | 20 |
| Activating the safety lock | 20 |
| Water softener | 21 |
| Displaying and setting the water hardness | 22 |
| Dishwasher salt | 23 |
| Filling the salt reservoir | 24 |
| Replenishing salt | 25 |
| Rinse aid | 26 |
| Adding rinse aid | 27 |
| Refilling rinse aid | 27 |
| Caring for the environment | 29 |
| Economical dishwashing | 29 |
| Loading the dishwasher | 30 |
| General information | 30 |
| Upper basket | 32 |
| Adjusting the upper basket | 34 |
| Lower basket | 35 |
| Cutlery tray/Cutlery basket (depending on model) | 36 |
| Loading the cutlery tray | 36 |
| Loading the cutlery basket | 37 |
| Loading examples | 38 |
| Dishwashers with cutlery tray | 38 |
| Dishwashers with cutlery basket | 40 |
| Comparison tests | 42 |
| Detergents | 48 |
| Types of detergents | 48 |

| | |
|--|----|
| Detergent dispensing | 49 |
| Adding detergent..... | 50 |
| Operation | 51 |
| Switching on the dishwasher | 51 |
| Selecting a programme | 51 |
| Display of programme duration | 52 |
| Starting a programme | 52 |
| At the end of the programme | 53 |
| Energy management | 53 |
| Switching off the dishwasher | 54 |
| Unloading the dishwasher..... | 54 |
| Interrupting a programme..... | 55 |
| Cancelling or changing a programme | 55 |
| Options | 56 |
| Timer | 56 |
| Guide for selecting a programme | 58 |
| Programme chart | 60 |
| Programme options | 62 |
| 🕒 Express..... | 62 |
| Switching off the refill reminders | 63 |
| Extra clean..... | 64 |
| Extra dry | 65 |
| Factory default settings | 66 |
| Cleaning and care | 67 |
| Cleaning the wash cabinet | 67 |
| Cleaning the door and the door seal | 68 |
| Cleaning the control panel | 68 |
| Cleaning the appliance front | 68 |
| Cleaning the spray arms..... | 69 |
| Checking the filters in the wash cabinet | 72 |
| Cleaning the filters..... | 72 |
| Cleaning the water inlet filter | 74 |
| Cleaning the drain pump | 75 |
| Problem solving guide | 77 |
| Technical problems | 77 |
| Fault messages | 78 |
| Water intake fault..... | 79 |
| Water drainage fault | 80 |

Contents

| | |
|--|----|
| General problems with the dishwasher | 81 |
| Noises..... | 82 |
| Unsatisfactory cleaning result | 83 |
| Service | 86 |
| Contact in case of fault | 86 |
| Warranty | 86 |
| Optional accessories | 87 |
| Installation | 89 |
| The Miele Waterproof system..... | 89 |
| Water intake | 89 |
| Drainage | 91 |
| Technical data | 94 |

Warning and Safety instructions

This dishwasher complies with all current local and national safety requirements. However, inappropriate use can lead to personal injury and damage to property.

Please observe the installation sheet and read the operating instructions carefully before setting up the dishwasher and using it for the first time. They both contain important information on the installation, safety, use, and maintenance of the machine. This prevents both personal injury and damage to the dishwasher.

In accordance with standard IEC 60335-1, Miele expressly and strongly advises that you read and follow the instructions in "Installation" and in "Warning and Safety instructions".

Miele cannot be held liable for injury or damage caused by non-compliance with these instructions.

Keep the installation sheet and the operating instructions in a safe place and pass them on to any future owner.

Warning and Safety instructions

Correct application

- ▶ This appliance is designed for domestic use and for use in similar environments by guests in hotel or motel rooms, bed & breakfasts, and other typical living quarters. This does not include common/shared facilities or commercial facilities within hotels, motels or bed & breakfasts.
- ▶ This dishwasher is not suitable for outdoor use.
- ▶ The dishwasher is intended for use at altitudes of up to 4,000 m above sea level.
- ▶ The dishwasher must only be used for cleaning domestic crockery and cutlery. Any other use is not permitted.
- ▶ This appliance is not intended for use by persons (including children) with reduced physical, sensory or mental capabilities, or lack of experience and knowledge, unless they have been given supervision or instruction concerning its use by a person responsible for their safety, and are able to recognise the dangers of misuse.

Safety with children

- ▶ Young children must not be allowed to use this appliance.
- ▶ Older children may only use the dishwasher if its operation has been clearly explained to them and they are able to use it safely. They must be able to understand and recognise the possible dangers of misuse.
- ▶ Cleaning work may only be carried out by older children under the supervision of an adult.
- ▶ Children should be supervised in the vicinity of the dishwasher. Keep small children away from the appliance at all times to avoid the risk of injury. Ensure that they do not play with the appliance. There is a risk that children may lock themselves in the dishwasher.
- ▶ If the automatic door opening mechanism is active (depending on the model), keep young children away from the area in which the door opens. There is a danger of injury in the unlikely event of a fault with the opening mechanism.
- ▶ Danger of suffocation! While playing, children may become entangled in packaging material (such as plastic wrapping) or pull it over their head with the risk of suffocation. Keep packaging material away from children.
- ▶ Keep detergents and other household cleaning agents out of reach of children. Some dishwasher detergents are strongly alkaline and contain irritants and corrosive ingredients. They can be extremely dangerous if swallowed, and can cause severe skin burns and eye damage. They can cause burning in the mouth, nose and throat, or inhibit breathing. Avoid contact with the skin and eyes. Keep children away from the dishwasher when the door is open. There could still be detergent residues in the cabinet or dispenser. Check that the dispenser is empty after the completion of a programme. Seek medical advice immediately if a child has swallowed or inhaled any detergent. Contact a Poisons Information Centre (Australia) or the National Poisons Centre (NZ).

Warning and Safety instructions

Technical safety

- ▶ Unauthorised installation, maintenance and repairs can cause considerable danger for the user. Installation, maintenance, and repairs must only be carried out by a Miele authorised technician.
- ▶ Damage to the dishwasher can compromise your safety. Before using the dishwasher and in particular following transport, check it for any visible damage. Never use a damaged dishwasher.
- ▶ The electrical safety of this dishwasher can only be guaranteed when continuity is complete between it and an effective earthing system. It is most important that this basic safety requirement is present. If in doubt, the electrical installation should be checked by a qualified electrician.
Miele cannot be held liable for the consequences of an inadequate earthing system (e.g. electric shock).
- ▶ Reliable and safe operation of the dishwasher can only be assured if it has been connected to the mains electricity supply.
- ▶ The dishwasher must only be connected to the electricity supply via a suitable switched socket. The socket must be easily accessible after the dishwasher is installed so that it can be disconnected from the electricity supply at any time.
- ▶ There must be no electrical sockets concealed behind the dishwasher because the building-in niche may be too small, creating a risk of overheating if the dishwasher were to be pushed up against the plug (fire hazard).
- ▶ The dishwasher must not be installed underneath a cooktop. The high temperatures radiated by cooktops could damage the dishwasher below. For the same reason, the dishwasher must not be installed next to open fires or other appliances that give off heat, such as heaters etc.

Warning and Safety instructions

- ▶ Ensure that the connection data on the dishwasher's data plate (fuse rating, frequency and voltage) match the electricity supply to prevent damage to the dishwasher. Compare these before connecting the appliance to the mains electricity. If in any doubt, consult a qualified electrician.
- ▶ Do not connect the dishwasher to the electricity supply until it has been fully installed and any adjustment has been made to the door springs.
- ▶ The dishwasher may only be operated if the door opening mechanism is working correctly, as otherwise there could be a danger when the automatic door opening is activated (depending on the model).
To check that the door opening mechanism is working correctly:
 - The door springs must be evenly adjusted on both sides. They are correctly adjusted when the door remains stationary when left half open (approx. 45° opening angle). The door must not fall open on its own beyond this point.
 - The door locking pins retract automatically after the drying phase when the door is opened.
- ▶ Multi-socket adapters and extension leads do not guarantee the required safety of the appliance (e.g. danger of overheating). Do not connect the dishwasher to the electricity supply using a multi-socket adapter or an extension cord.
- ▶ The dishwasher must not be installed and operated in mobile locations (e.g. on a ship).
- ▶ Do not install the dishwasher in a room where there is a risk of frost. Frozen hoses can break or burst. The reliability of the electronic control unit may be impaired at temperatures below freezing point.
- ▶ To avoid any damage to the dishwasher, it must only be operated when it is connected to a fully vented plumbing system.

Warning and Safety instructions

- ▶ The plastic housing of the water connection contains an electrical valve. The housing must not be dipped in water.
- ▶ There are live wires in the water inlet hose. Do not cut the hose, even if it is too long.
- ▶ The integrated water protection system offers protection from water damage, provided the following conditions are met:
 - Installation has been carried out correctly.
 - The dishwasher is properly maintained and parts are replaced when they are visibly damaged.
 - The tap is turned off during longer absences from the home (e.g. whilst on holiday).

The Waterproof system will work even when the dishwasher is switched off. However, the dishwasher must remain connected to the electricity supply.

- ▶ The water connection pressure needs to be between 50 and 1,000 kPa.
- ▶ A damaged dishwasher could be dangerous. If the dishwasher gets damaged, switch it off at the mains immediately and contact Miele customer service.
- ▶ The manufacturer's warranty will be invalidated if the appliance is not repaired by a Miele authorised service technician.
- ▶ Defective components must be replaced with original parts. If original Miele parts are installed correctly, Miele ensures full compliance with safety requirements and the warranty remains valid.
- ▶ During installation, maintenance, and repair work, the dishwasher must be disconnected from the electricity supply (switch it off and withdraw the plug from the socket).
- ▶ If the mains connection cable is damaged, it must be replaced with a special cable of the same type (available from Miele) by a Miele authorised service technician only in order to avoid a hazard.

Warning and Safety instructions

▶ In areas which may be subject to infestation by cockroaches or other vermin, pay particular attention to keeping the appliance and its surroundings in a clean condition at all times. Any damage which may be caused by cockroaches or other vermin will not be covered by the warranty.

Correct installation

▶ The dishwasher must be installed and connected in accordance with the installation instructions and the supplied installation plan.



▶ Be careful before and while installing the dishwasher. Some metal parts pose a risk of injury/cutting. Wear protective gloves.

▶ The dishwasher must be correctly aligned horizontally to ensure trouble-free operation.

▶ In order to ensure stability, built-under and integrated dishwashers must only be installed under a continuous countertop which is secured to adjacent cabinetry.

▶ The dishwasher must only be built into a tall unit if additional safety precautions are taken. In order to safely install the appliance in a tall unit, please use the "Tall unit installation kit" and observe the installation plan provided. Otherwise there is the danger of the unit tipping over.

▶ The door springs must be evenly adjusted on both sides. They are correctly adjusted when the door remains stationary when left half open (approx. 45° opening angle). The door must not fall open on its own beyond this point.

The appliance must only be operated with properly adjusted door springs.

If the door cannot be adjusted properly, contact Miele customer service.

The maximum weight of the front panel that can be aligned with the factory fitted door springs is 10–12 kg (depending on model).

Warning and Safety instructions

Correct use

- ▶ Do not use solvents in the dishwasher. There is a danger of explosion.
- ▶ Do not inhale or ingest dishwasher detergent. Some dishwasher detergents are strongly alkaline and contain irritants or corrosive ingredients. They can be extremely dangerous if swallowed, and can cause burning in the eyes, nose, mouth, and throat, or inhibit breathing. Avoid contact with the skin and eyes. Do not inhale powder detergents. Do not swallow dishwasher detergents. Seek medical advice immediately if detergent has been swallowed or inhaled. Contact a Poisons Information Centre (Australia) or the National Poisons Centre (NZ).
- ▶ Avoid leaving the dishwasher door open unnecessarily. You could injure yourself on the open door or trip over it.
- ▶ Do not sit, stand, or lean on the open door. The dishwasher could tip over. This could injure you or damage the dishwasher.
- ▶ Dishes may be very hot at the end of the programme. Allow the dishes to cool until they are comfortable enough to handle before unloading them.
- ▶ Only use detergent and rinse aid formulated for domestic dishwashers. Do not use washing-up liquid.
- ▶ Do not use any commercial or industrial detergents. These may cause material damage, and there is a risk of a severe explosive chemical reaction (such as an explosive oxyhydrogen gas reaction).
- ▶ Do not fill the rinse aid reservoir with powder or liquid detergent. This will cause serious damage to the rinse aid reservoir.
- ▶ Do not fill the salt reservoir with powder or liquid detergent. Dishwasher detergent will damage the water softener.

Warning and Safety instructions

- ▶ Only use special coarse-grained dishwasher salt or other pure evaporated salts for reactivation. Other types of salt (such as cooking salt, rock salt, agricultural grade or gritting salt) may contain insoluble components which can impair the functioning of the water softener.
- ▶ In dishwashers with a cutlery basket (depending on model), knives and forks should be placed with the handles upwards in the basket for safety reasons. Knives and forks placed with the handles downwards pose a danger of injury. However, cutlery placed handle down in the cutlery basket will come out cleaner and drier.
- ▶ Plastic items which cannot withstand being washed in hot water, such as disposable plastic containers or plastic cutlery, should not be cleaned in the dishwasher. The high temperatures in the dishwasher may cause them to melt or lose shape.
- ▶ If you use the timer option (depending on model), the detergent compartment must be dry. Wipe dry with a cloth first if necessary. The detergent will clump together if the detergent compartment is not dry, and it may not be fully rinsed out.
- ▶ Please observe the information listed under Technical data regarding the capacity of the dishwasher.

Accessories and spare parts

- ▶ Only use original Miele accessories. If other parts are used, warranty, performance, and, if applicable, product liability claims will be invalidated.
- ▶ Miele will guarantee to supply functional spare parts for a minimum of 10 years and up to 15 years following the discontinuation of your dishwasher.

Warning and Safety instructions

Transport

- ▶ Damage to the dishwasher can compromise your safety. Before using the dishwasher, check it for any visible transport damage. Never use a damaged dishwasher.
- ▶ Only transport the dishwasher in an upright position so that no water flows into the electrical controls, as this would cause faults.
- ▶ If you wish to transport the dishwasher, empty it and securely fasten all loose parts such as baskets, hoses, and cables.

Disposal of your old dishwasher

- ▶ Make the door lock inoperative so that children cannot accidentally shut themselves in. Remove or destroy the locking bracket of the door lock, and make appropriate arrangements for the disposal of the appliance.

Notes on the operating instructions

These operating instructions apply to several different dishwasher models of different heights. The different dishwasher models will be named as follows:
Standard = dishwasher measuring 80.5 cm high (built-in appliance) or 84.5 cm high (freestanding appliance)
XXL = dishwasher measuring 84.5 cm high (built-in appliance).

Notes on the layout

Warnings

 Information which is important for safety is highlighted in a thick framed box with a warning symbol. This alerts you to the potential danger of injury to people or damage to property. Read these warning notes carefully and observe the procedural instructions and codes of practice they describe.

Notes

Notes contain information of particular importance that must be observed. They are highlighted by a thick framed box.

Additional information and comments

Additional information and comments are highlighted in a box framed with a thin black line.

Instructions for the user

Instructions on how to operate the dishwasher are identified by marked operating steps. They explain the procedure step by step. Operating steps are indicated by a black square bullet point.

Example:

- Select the setting you want and press *OK* to confirm.

Items supplied

The following items are supplied:

- Dishwasher
- Operating instructions for operating the dishwasher
- Installation sheet for installing the dishwasher
- Other installation accessories for installing the dishwasher (see installation sheet)
- Funnel for filling the dishwasher salt
- Additional printed matter and add-ons if required

Appliance overview

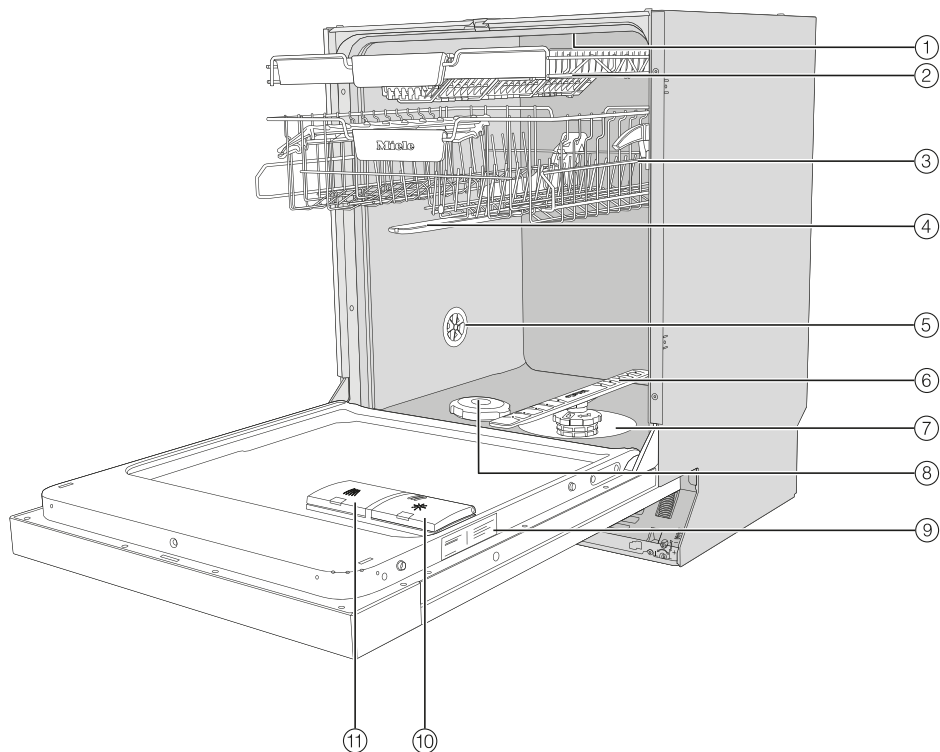

- ① Upper spray arm (not visible)
- ② Cutlery tray (depending on model)
- ③ Upper basket
- ④ Middle spray arm
- ⑤ Aeration valve
- ⑥ Lower spray arm
- ⑦ Filter combination
- ⑧ Salt reservoir
- ⑨ Data plate
- ⑩ Rinse aid reservoir
- ⑪ Detergent compartment

Guide to the appliance

Control panel

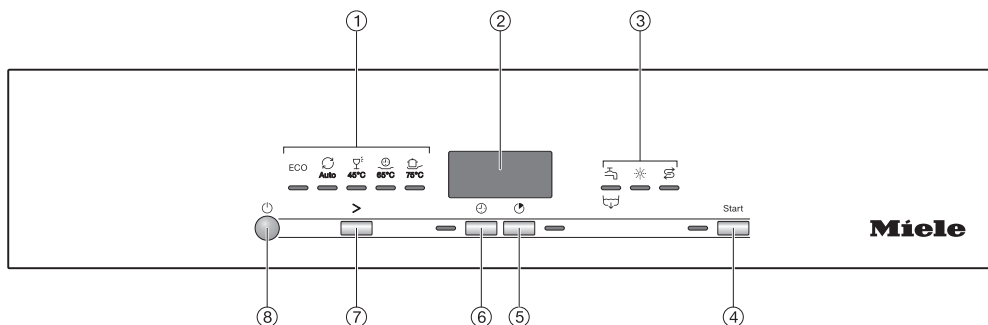

① Programme selection

- ECO = ECO
- Auto = Auto 45–65 °C
- 45 °C = Gentle 45 °C
- 65 °C = QuickPowerWash 65 °C
- 75 °C = Intensive 75 °C

② Time display

③ Check/Refill indicators

- Inlet / Drain
- Rinse aid
- Salt

④ Start button with indicator light

For starting the selected programme.

⑤ Express button

For reducing the programme duration.

⑥ Timer button

For selecting a later programme start.

⑦ Programme selection button >

For programme selection.

⑧ On/Off button

For switching the dishwasher on and off.

Disposal of the packing material

The transport and protective packaging has been selected from materials which are environmentally friendly for disposal, and can normally be recycled.

Recycling the packaging reduces the use of raw materials in the manufacturing process and also reduces the amount of waste in landfill sites. Ensure that any plastic wrappings, bags etc. are disposed of safely and kept out of the reach of babies and young children. Danger of suffocation.

Disposing of your old appliance

Electrical and electronic appliances often contain valuable materials. They also contain specific materials, compounds and components, which were essential for their correct function and safety. These could be hazardous to human health and to the environment if disposed of with your domestic waste or if handled incorrectly. Please do not, therefore, dispose of your old appliance with your household waste.



Please dispose of it at your local community waste collection / recycling centre for electrical and electronic appliances. You are also responsible for deleting any personal data that may be stored on the appliance prior to disposal. Please ensure that your old appliance poses no risk to children while being stored prior to disposal.

Using for the first time

Every dishwasher is tested at the factory. There will be residual water in the machine from this test. It is not an indication that the dishwasher has been used previously.

Opening the door

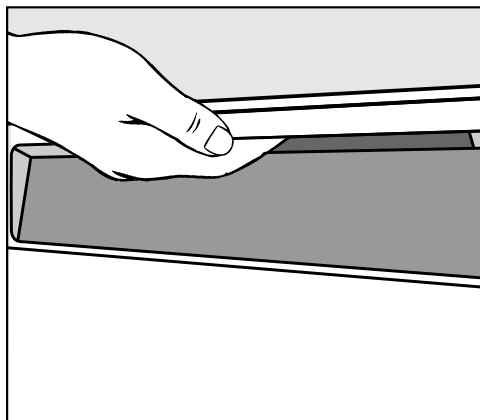

- To open the door, reach under the door grip and pull.

If the door is opened during operation, all functions are automatically interrupted.

 Risk of scalding due to hot water.

During operation, water in the dishwasher may be very hot. Only open the door if absolutely necessary and exercise extreme caution when doing so.

Closing the door

- Push the baskets right in.
- Then raise the door up and push until it clicks into position.

 Risk of crushing due to the door closing.

When closing the door, you are at risk of jamming your fingers in it.

Do not put your hand inside the door as it is closing.

Activating the safety lock

Use the safety lock to prevent children opening the dishwasher door. The door can then only be opened by using a lot of force.

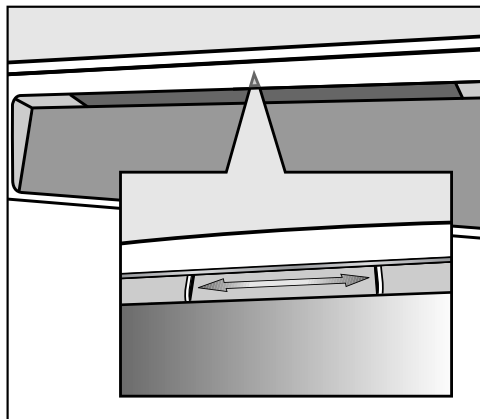

- To lock the door, push the slide underneath the door grip to the right.
- To unlock the door, push the slide to the left.

Water softener

In order to achieve good cleaning results, the dishwasher needs to operate with soft (low limescale) water. Hard water results in the build-up of calcium deposits on crockery and in the appliance.

Water with a hardness level higher than 0.9 mmol/l (5 °dH – German scale) must be softened. This occurs automatically in the integrated water softener. The water softener is suitable for a water hardness level of up to 12.5 mmol/l (70 °dH - German scale).

In order to be reactivated, the water softener requires dishwasher salt. Depending on the water hardness level (< 3.8 mmol/l, or < 21 °dH – German scale), dishwasher salt is not required if combination detergents are being used (see “Detergents - Types of detergents”).

- The dishwasher needs to be programmed to the correct water hardness for your area.
- Your local water authority will be able to advise you of the water hardness level in your area.
- Where the water hardness fluctuates, e.g. between 1.8 and 2.7 mmol/l (10 - 15 °dH - German scale), always programme the dishwasher to the higher value (2.7 mmol/l or 15 °dH in this example).

If the water hardness in your area is available in a unit other than °dH, you can convert the values as follows:
 $1\text{ °dH} = 0.18\text{ mmol/l} = 1.78\text{ °fH}$



The dishwasher is programmed at the factory for a water hardness level of 0.36 mmol/l (2 °dH - German scale).

If your water hardness level corresponds to this setting, you can skip to the next section.

However, if you have a different water hardness level, you must adjust the water softener to match your water hardness.

Using for the first time

Displaying and setting the water hardness

- Switch the dishwasher off with the  button, if it is switched on.
- Press the *Start* button in and, **whilst holding it in**, switch the dishwasher on using the  button. Keep the *Start* button pressed in for at least 4 seconds until the *Start* indicator light comes on.

If this does not happen, start the procedure from the beginning again.

- Press the > programme selection button 2 times.

The left programme indicator light will flash rapidly 2 times at intervals.

The value set is shown as a figure after *P* in the time display.

P14 will start flashing in the display. A water hardness of 2.5 mmol/l (14 °dH – German scale) is set.

- Use the *Start* button to set the water hardness level for your area. The setting increases each time you press the button. When the highest value is reached, the setting starts again from the beginning.

The setting is now stored in memory.

- Switch the dishwasher off with the  button.

Dishwasher salt

In order to maintain the functioning of the water softener, it must be reactivated regularly.

In order to be reactivated, the water softener requires dishwasher salt. Depending on the water hardness level (< 3.8 mmol/l, or < 21 °dH – German scale), dishwasher salt is not required if combination detergents are being used (see “Detergents - Types of detergents”).

If the water in your area is very soft and constantly **lower than 0.9 mmol/l (5 °dH - German scale)** you do **not** need to add dishwasher salt. The salt refill indicator will automatically switch off after the water hardness has been set accordingly (see “Using for the first time – Displaying and setting the water hardness”).

 Damage to the water softener from detergents.

Dishwasher detergent will damage the water softener.

Do not fill the salt reservoir with powder or liquid detergent.

 Damage caused by using unsuitable salts.

Other types of salt (such as cooking salt, rock salt, agricultural grade or gritting salt) may contain insoluble components which can cause the water softener to malfunction.

Only use special coarse-grained dishwasher salt or other pure evaporated salts for reactivation.

If you only ever use combination detergent products containing salt and rinse aid in your dishwasher, you can switch off both refill reminders if you wish (see “Programme options – Switching off the refill reminders”).

Please make sure that if you stop using combination detergents, you refill the dishwasher salt and rinse aid. Switch the refill reminders back on if required.

Using for the first time

Filling the salt reservoir

Before filling the salt reservoir for the first time, you must fill it with approx. 2 litres of water to enable the salt to dissolve.

Once the dishwasher has been used, there is always sufficient water in the salt reservoir.



- Remove the lower basket from the wash cabinet and unscrew the salt reservoir cap.

 Risk of corrosion due to saline solution.

Water or saline solution will run out of the reservoir when the cap is opened. Saline solution that runs out can cause corrosion in the wash cabinet and to the dishwasher load. The salt reservoir should therefore only be opened to replenish the salt.

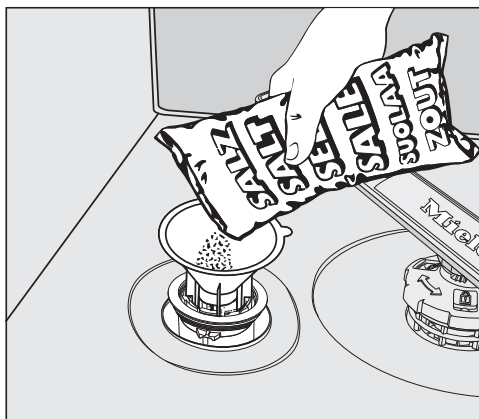
- Fill the salt reservoir with approx. 2 l of water (first use only).





- Place the funnel provided on the salt reservoir and carefully fill with dishwasher salt until the reservoir is full. The salt reservoir holds up to 2 kg of salt, depending on the type of salt used.
- Clean off salt residues from around the salt reservoir opening. Next, screw the salt reservoir cap on again firmly.
- Immediately after filling the salt container, run the  65 °C *QuickPowerWash* programme with the  *Express* option and without any load in the dishwasher to dissolve and remove any traces of salt from the wash cabinet.

Replenishing salt

- When the *Salt*  indicator lights up, wait until the end of the programme and then refill the salt reservoir.

 Risk of corrosion due to saline solution.

Saline solution that runs out can cause corrosion in the wash cabinet and to the dishwasher load.

Each time you have opened the salt reservoir cap, immediately run the  65 °C *QuickPowerWash* programme with the  *Express* option and without any dishes. This will dissolve and remove any traces of salt from the wash cabinet.

After the salt reservoir has been filled, the refill reminder may still appear in the display if the salt concentration has not yet reached the correct level. It will go out once the salt concentration has reached the correct level.

The salt refill indicator is deactivated if the dishwasher is set to a water hardness below 0.9 mmol/l (5 °dH - German scale).

Using for the first time

Rinse aid

Rinse aid is necessary to ensure water does not cling to and leave marks on crockery during the drying phase, and it helps crockery dry faster after it has been washed.

Rinse aid is poured into the storage reservoir and the amount set is dispensed automatically.

 Washing-up liquid or detergent can cause damage.

Washing-up liquid and dishwasher detergent will damage the rinse aid reservoir.

Only fill it with rinse aid formulated for domestic dishwashers.

Alternatively, you can use liquid citric acid with up to 10% acid content. The dishes will, however, be more moist and stained than with rinse aid.

 Risk of acid damage.

The dishwasher can be damaged by acids with a higher concentration.

Never use citric acid or vinegar with a higher acid content.

If you only ever use combination detergent products in your dishwasher, you do not need to fill the rinse aid reservoir.

However, the best rinsing and drying results will be achieved by using a detergent together with separate dishwasher salt and rinse aid.

Please make sure that if you stop using combination detergents, you refill the dishwasher salt and rinse aid. Switch the refill reminders back on if required.

Using for the first time

Adding rinse aid

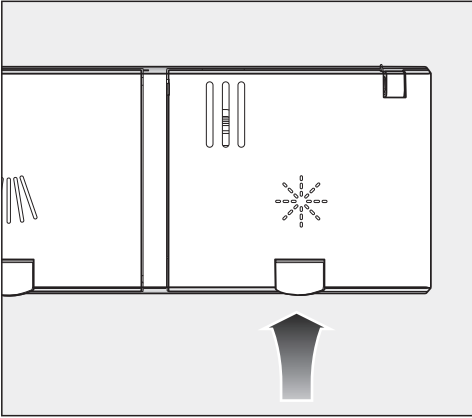

- Lift the yellow button on the lid of the rinse aid container .

The lid will open.

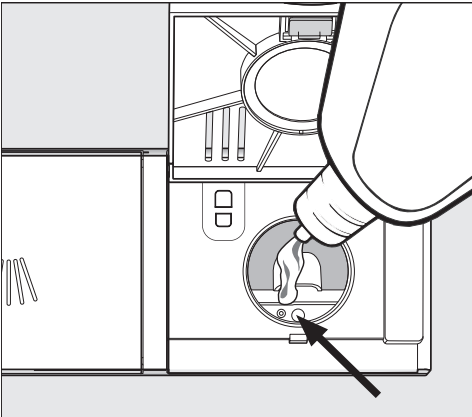

- Only add rinse aid until the fill level indicator (see arrow) turns dark when the door is open horizontally.

The rinse aid reservoir holds approx. 110 ml.

- Close the flap firmly so that it clicks into place. Otherwise water can enter the rinse aid reservoir during a programme.

- Wipe up any spilled rinse aid. This prevents over-foaming occurring during the next programme.

Refilling rinse aid

When the  *Rinse aid* refill reminder lights up in the display, the reservoir contains sufficient rinse aid for 2 to 3 programmes only.

- Add rinse aid in good time.

The refill rinse aid reminder will go out.

If you only ever use combination detergent products containing salt and rinse aid in your dishwasher, you can switch off both refill reminders if you wish (see “Programme options – Switching off the refill reminders”).

Using for the first time

Setting the rinse aid dosage

You can adjust the rinse aid dosage for best results.

The rinse aid dosage can be set from 0 to 6 ml.

3 ml is the factory default setting.

If spots appear on crockery and glassware:

- Increase the rinse aid dosage.

If clouding or smearing appears on crockery and glassware:

- Decrease the rinse aid dosage.

■ Switch the dishwasher off with the  button, if it is switched on.

■ Press the *Start* button in and, **whilst holding it in**, switch the dishwasher on using the  button. Keep the *Start* button pressed in for at least 4 seconds until the *Start* indicator light comes on.

If this does not happen, start the procedure from the beginning again.

■ Press the > programme selection button 3 times.

The left programme indicator light will flash rapidly 3 times at intervals.

The dosage set will appear in the display after *P*.

P 3 will start flashing in the display. Setting 3 is set.

■ Select required setting with the *Start* button.

The setting increases each time you press the button. When the highest value is reached, the setting starts again from the beginning.

The setting is now stored in memory.

■ Switch the dishwasher off with the  button.

Economical dishwashing

This dishwasher is exceptionally economical in its use of water and electricity.

You can support the economical operation of your appliance by following these tips:

- Washing in a dishwasher generally uses less water and energy than washing dishes by hand.
 - Pre-rinsing dishes under running water is not necessary and unnecessarily increases water and energy consumption.
 - For the most economical dishwashing, make full use of the basket capacity without overloading the dishwasher. This results in the most economical use of the dishwasher in terms of energy and water consumption.
 - Choose the programme to suit the type of crockery being washed and the degree of soiling (see “Programme chart”).
 - Select the *ECO* programme for energy-saving dishwashing. This programme is the most efficient in terms of its combined energy and water consumption for cleaning dishes with a normal level of soiling.
 - Follow the detergent manufacturer’s recommendations on detergent dosage.
 - When using powder or liquid detergent, you can use $\frac{1}{3}$ less detergent if the baskets are only half full.
- You can connect the dishwasher to a hot water supply. A hot water connection is particularly suitable with energy-saving water heating sources, such as solar water heaters. If the water is heated by electricity, we recommend connection to cold water.

Loading the dishwasher

General information

Remove coarse food residues from crockery.

There is no need to pre-rinse items under running water.

 Damage can be caused by ash, sand, wax, lubricating grease, or paint.

These substances will contaminate the dishwasher and can then no longer be removed.

Do not wash items soiled with these substances in the dishwasher.

Dishes can be loaded anywhere in the baskets. However, please try to observe the following notes:

- Do not place dishes and utensils inside other items where they will cover one another.
- Load the crockery so that water can access all surfaces. This ensures that they will get properly cleaned.
- Make sure that all items are securely positioned.
- Hollow items such as cups, glasses, and saucepans etc. must be inverted in the baskets.
- Tall and narrow, hollow items such as champagne glasses should be placed in the centre of the basket rather than in the corners. This ensures the hollow items are more easily accessed by the water jets.
- Wide based items should be placed at an angle so that water can run off them freely.

- The spray arms must not be blocked by items that are too tall or hang through the baskets. Test for free movement by manually rotating the spray arms.
- Make sure that small items cannot fall through the holders in the baskets.
Small items such as lids should therefore be placed in the cutlery tray or cutlery basket (depending on model).

Some foods such as carrots, tomatoes, or tomato sauce may contain natural dyes. These dyes can discolour plastic items in the dishwasher if large quantities of these foods are in contact with the crockery inside the machine. The stability of plastic items is not affected by this discolouration.
Washing silverware can also cause plastic items to discolour.

Items not suitable for washing in the dishwasher:

- Wooden cutlery and crockery or items with wooden parts. These may discolour and fade. Furthermore, the glue used in these items is not dishwasher safe. Wooden handles may come loose after being washed in the dishwasher.
- Craft items, antiques, valuable vases, and decorative glassware. Such items are not suitable for dishwashers.
- Plastic items that are not heat resistant. The high temperatures in the dishwasher may cause them to melt or lose shape.
- Copper, brass, tin, and aluminium items. These may discolour or become dull.
- Colours painted over a glaze. These may fade after a number of washes.
- Delicate glassware and glassware containing lead crystal. Clouding may occur over time.

Silverware

Silver can discolour when in contact with foods containing sulphur. These include egg yolk, onions, mayonnaise, mustard, pulses, fish, fish brine, and marinades.

Silverware previously cleaned with a **silver polish** may still be damp or spotted at the end of a programme, as water has not run off smoothly.

Useful tip: Rub the silverware dry with a cloth.

 Damage due to caustic alkaline detergents.

Aluminium parts (e.g. the grease filters of rangehoods) can be damaged by caustic alkaline detergents. In extreme cases, there is a risk of an explosive chemical reaction (such as an explosive oxyhydrogen gas reaction).

Aluminium components must not be cleaned in the dishwasher with caustic alkaline commercial or industrial detergents.

Useful tip: When purchasing new crockery and cutlery, make sure they are dishwasher safe if you want to wash them in the dishwasher.

Glass care

- Clouding may occur on glasses after frequent washing in the dishwasher. When washing delicate glassware in the dishwasher, select a special glass care programme with a low temperature (see “Programme chart”). This will reduce the risk of clouding.
- Purchase glassware that is dishwasher safe (e.g. Riedel glassware).
- Use detergents with glass protective additives.

Loading the dishwasher

Upper basket

See “Loading the dishwasher - Loading examples” for examples of how to load crockery and cutlery.

Loading the upper basket

 **Damage due to leaking water.**
If you run the dishwasher without the upper basket, water can leak out of the dishwasher.
Only run the dishwasher with the upper basket in place (except with the programme *Tall items*, if available).

- Use the upper basket for small, lightweight, and delicate items such as cups, saucers, glasses, dessert bowls, etc.
Shallow pans or casserole dishes can also be placed in the upper basket.
- Long items such as soup ladles and mixing spoons should be placed lying down across the front of the upper basket.

Loading the FlexCare cup rack

You can put cups, small bowls, and flat dishes on the FlexCare cup rack. Glasses can be arranged along the cup rack so they sit securely during the programme.

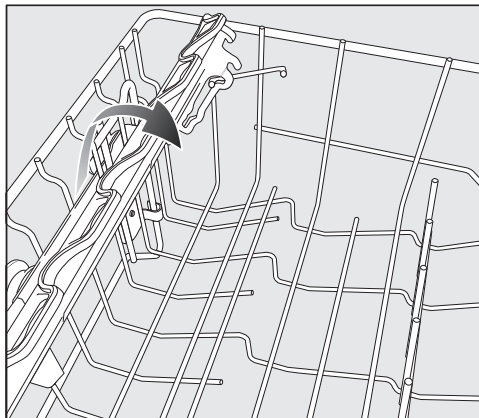

- Fold down the cup rack.
- Raise the cup rack upwards to make room for tall items.

Adjusting the FlexCare cup rack

You can set the height and depth of the cup rack at 2 different levels so that it can accommodate larger cups and so that taller items can be placed underneath it.

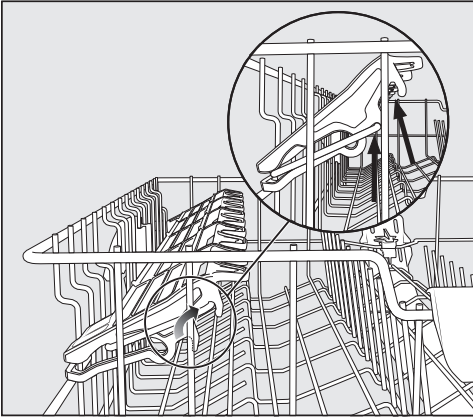

- Pull the cup rack upwards and click it into the desired position (see arrows).

Loading the dishwasher

Adjusting the upper basket

In order to gain more space for taller items, the upper basket can be adjusted on three levels with 2 cm between each level.

The upper basket can also be set at an angle so that water can run off freely from recesses. However, make sure that the basket can slide smoothly in and out of the wash cabinet.

- Pull out the upper basket.

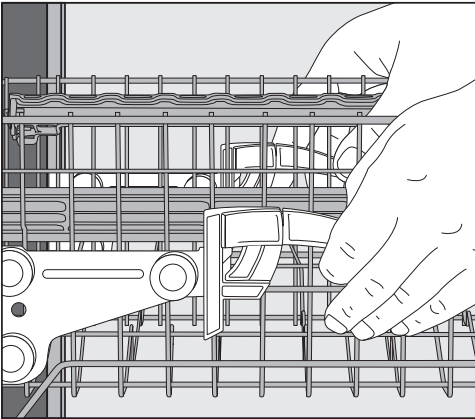

To raise the upper basket:

- Pull the basket up until it clicks into place.

To lower the upper basket:

- Pull upwards on the levers at either side of the upper basket.
- Adjust the basket to the desired height and then push the levers securely back down into position.

When adjusting the upper basket, make sure items in the lower basket do not block the middle spray arm.

Loading the dishwasher

Lower basket

See “Loading the dishwasher - Loading examples” for examples of how to load crockery and cutlery.

Loading the lower basket

- Place larger and heavier items such as plates, serving platters, saucepans, serving bowls etc., in the lower basket.
Glasses, cups, small plates and saucers can also be placed in the lower basket.

Loading the MultiComfort area

The rear section of the lower basket is used for washing cups, glasses, plates, and saucepans.

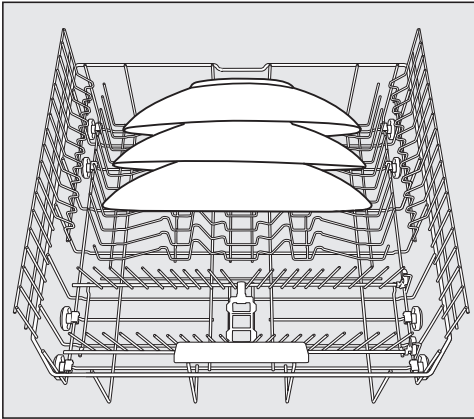

- Place large platters and dishes in the centre of the lower basket.

Useful tip: When tilted, plates up to 35 cm in diameter can be accommodated.

Lowering the spikes

The rows of spikes at the front are used for washing plates, soup bowls, platters, dessert bowls and saucers.

Both right-hand rows of spikes can be folded down to make more room for large items such as pots, pans, and serving dishes and bowls.

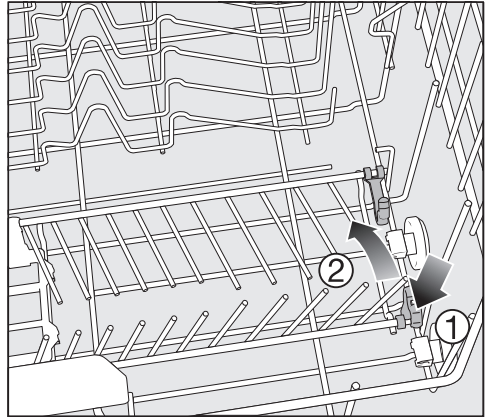

- Press the yellow lever downwards ① and then lower the spikes ②.

Loading the dishwasher

Cutlery tray/Cutlery basket (depending on model)

See “Loading the dishwasher - Loading examples” for examples of how to load crockery and cutlery.

- Load the utensils into the cutlery tray or into the cutlery basket (depending on model).

Loading the cutlery tray

To make unloading easier, cutlery should be grouped in zones: one for knives, one for forks, one for spoons, etc.

Spoon heads should be placed to rest on the serrated retainers on the base of the tray to ensure that water runs off them freely.

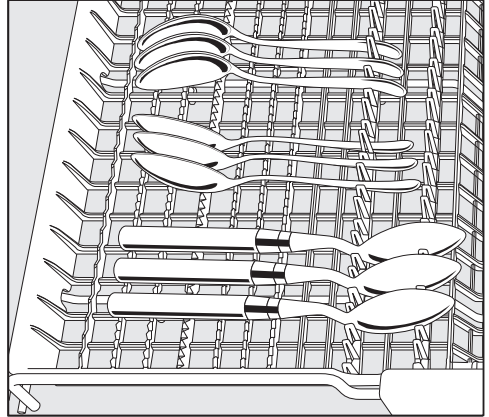

- If spoon handles do not fit between the holders, lay them the other way round.

Arrange tall items (such as cake servers) so that they do not block the upper spray arm.

Loading the dishwasher

Loading the cutlery basket

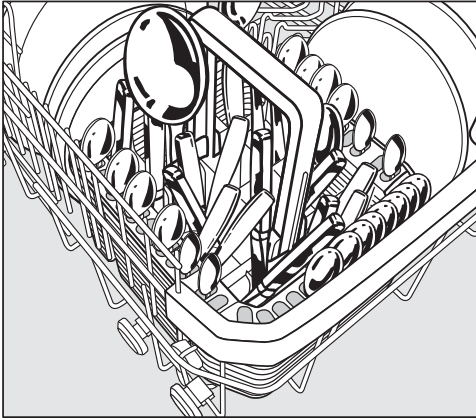

The cutlery basket can be placed anywhere on the front rows of spikes in the left or right corner of the lower basket.

- To avoid the risk of injury, knives and forks should be placed with the handles upwards in the cutlery basket. However, cutlery placed handle down in the cutlery basket will come out cleaner and drier.
- Place small items of cutlery in the individual slots on three sides of the cutlery basket.

Loading the cutlery insert for the cutlery basket

Use the insert supplied for heavily soiled items of cutlery. As this insert separates the items, they do not overlap and can be more easily accessed by the water jets.

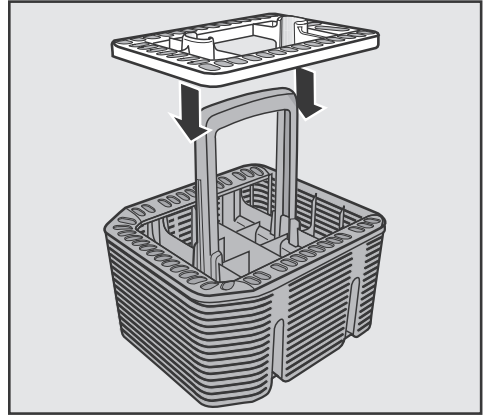

- Fit the insert onto the cutlery basket if required.

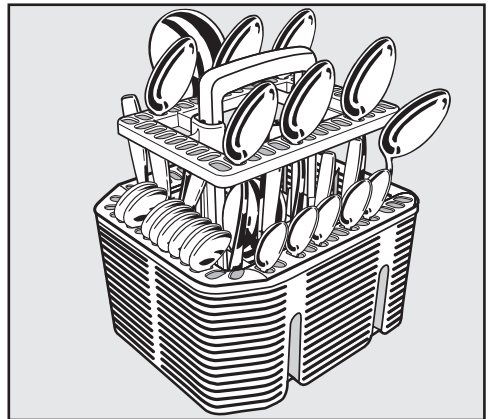

- Place cutlery into the insert with the handles facing downwards.
- Arrange them evenly along the insert.

Loading the dishwasher

Loading examples

Dishwashers with cutlery tray

Upper basket

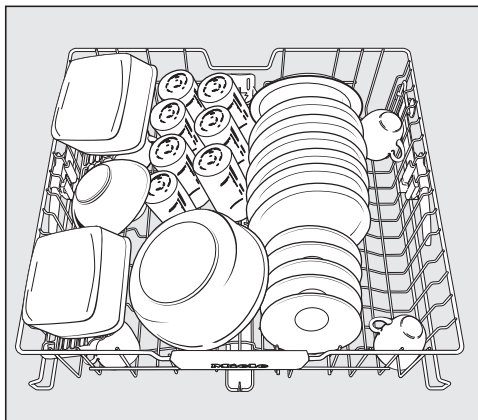
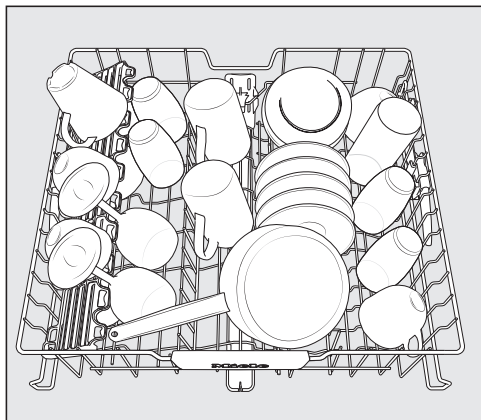

Lower basket

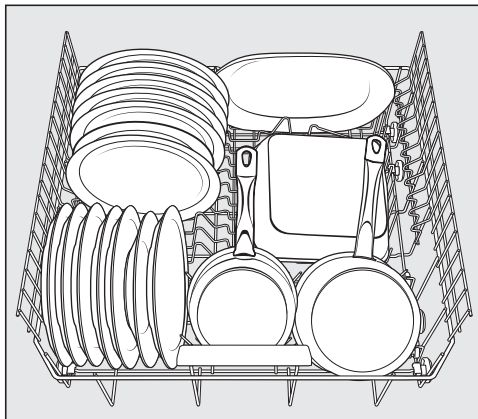
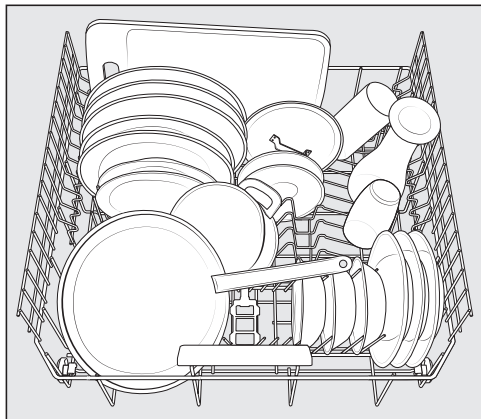

Loading the dishwasher

Cutlery tray

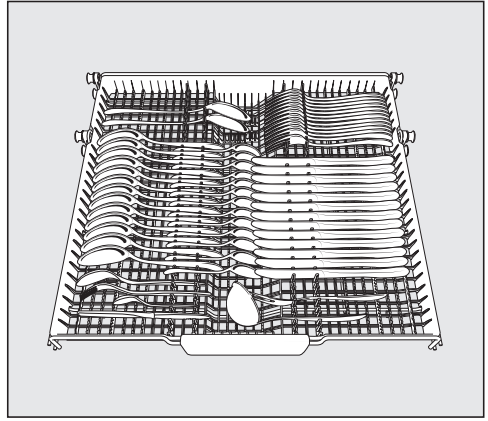
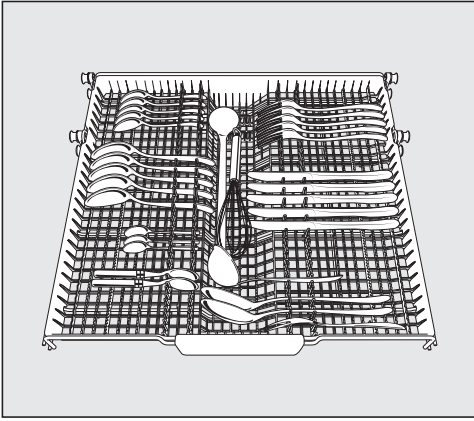

Heavily soiled items

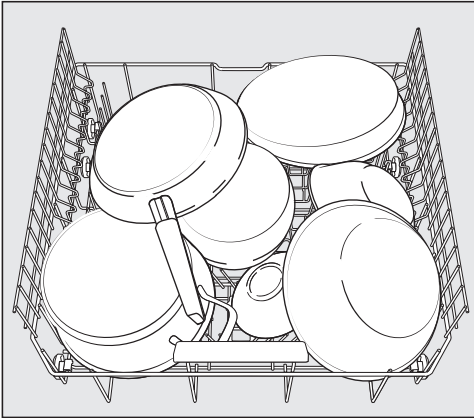

Loading the dishwasher

Dishwashers with cutlery basket

Upper basket

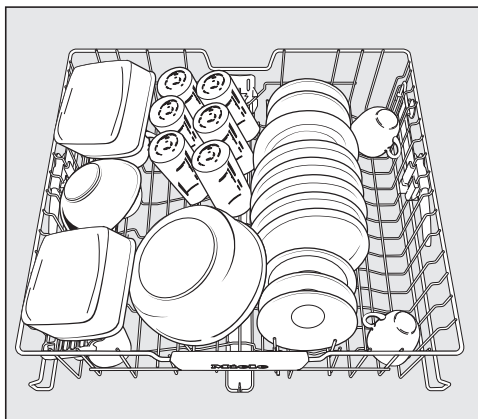
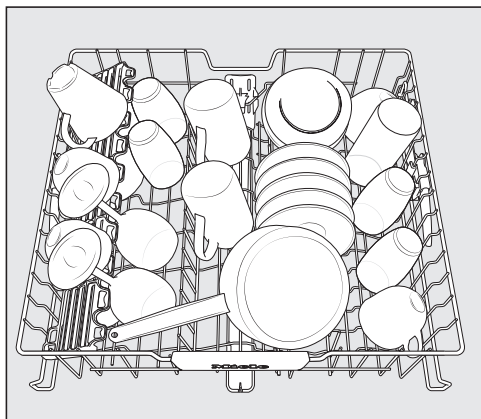

Lower basket

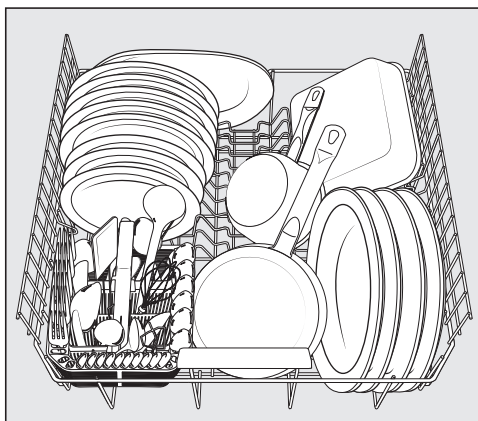
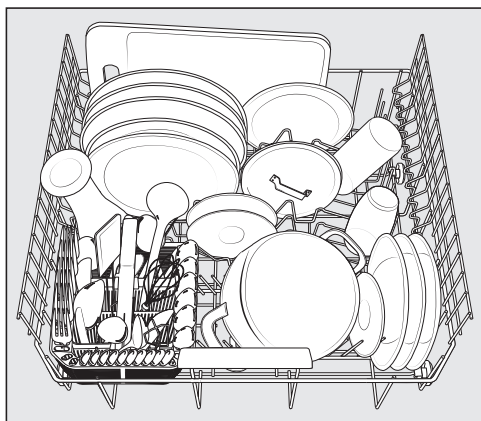

Loading the dishwasher

Cutlery basket

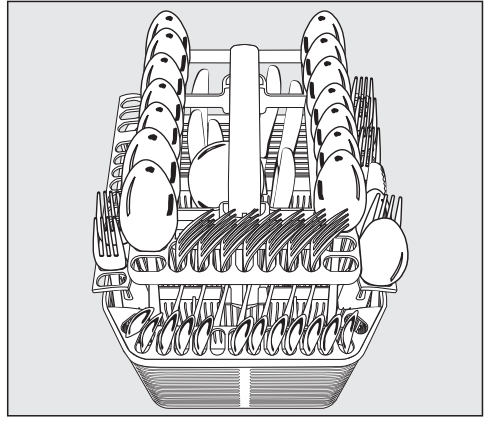
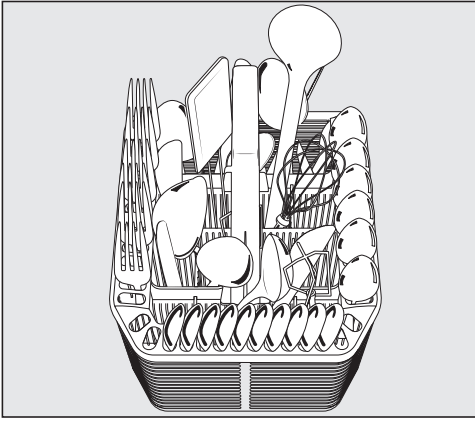

Heavily soiled items

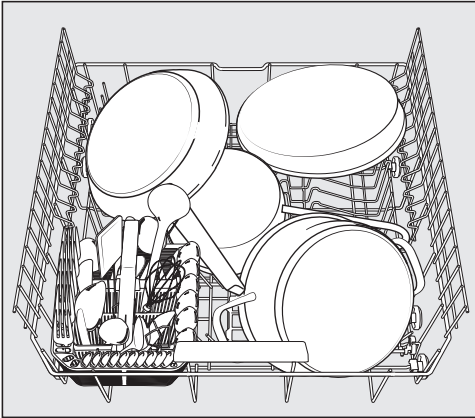

Comparison tests

| | |
|--|---|
| Test standard: | AS/NZS 2007.1:2005, AS/NZS 2007.2:2005; AS/NZS 6400:2005 |
| Standard programme (for energy label): | ECO |
| Capacity: | 🍴🍴 14 place settings |
| Detergent amount: | 32.5 g |
| Rinse aid dosage: | Setting 3 |

You can find information on adjusting the rinse aid dosage in the "Rinse aid" section of this booklet.

Upper basket setting:

| | |
|--------------------------------------|---|
| Position: | Bottom |
| FlexCare cup rack (if available): | Left lower position, right upper position |
| Drying measurements: | Door ajar using a block of approximately 50 mm upon completion of dry test. |

Loading examples

Pictures illustrating how to load the dishwasher for each model (see data plate) are shown on the following pages.

Picture ①: Upper basket

Picture ②: Lower basket

Picture ③: Cutlery basket

Do not lower or remove the basket inserts.

Capacity

☞ 14

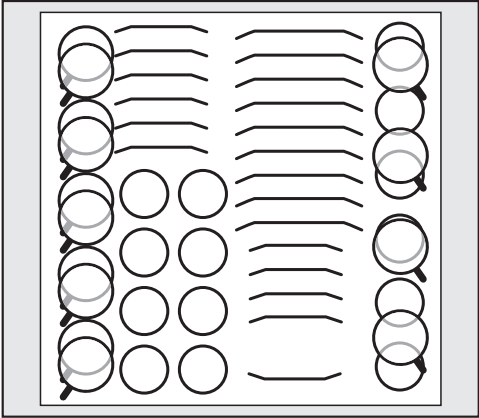

Upper basket

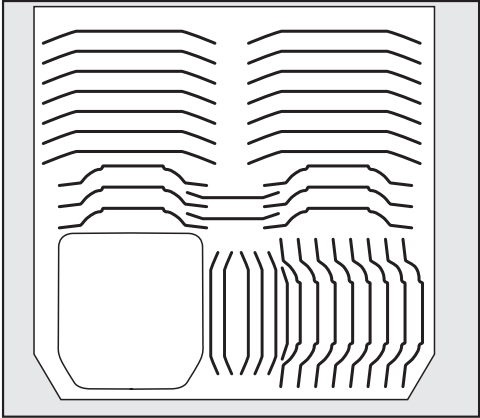

Lower basket

Comparison tests

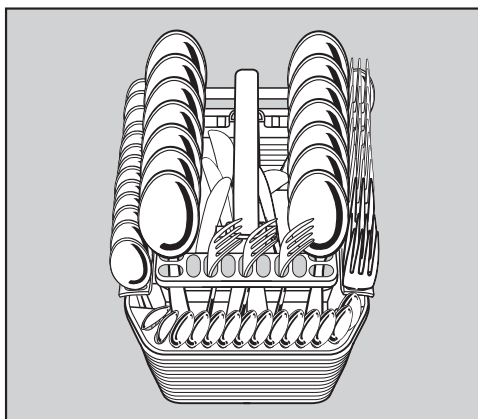
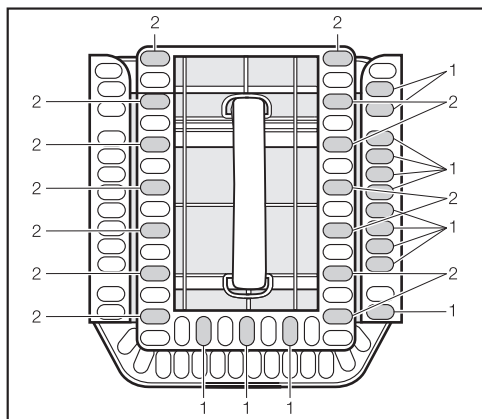
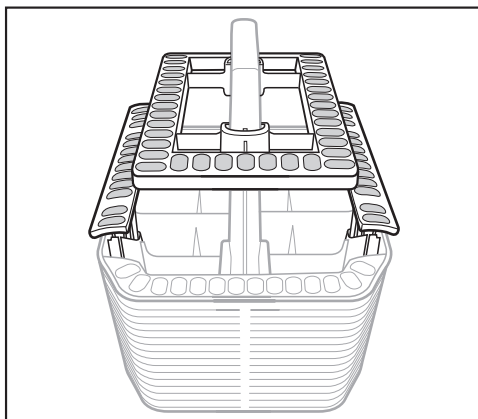
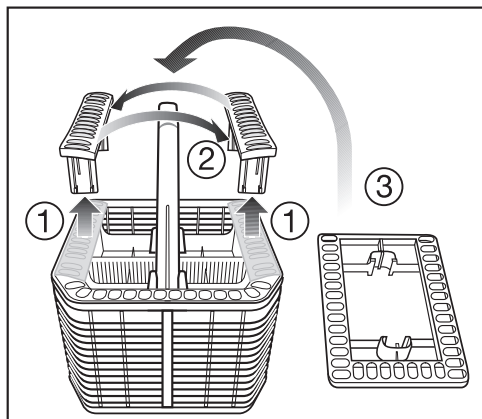

Cutlery basket

1 fork

2 soup spoons

| | |
|--|---|
| Test standard: | AS/NZS 2007.1:2005, AS/NZS 2007.2:2005; AS/NZS 6400:2005 |
| Standard programme (for energy label): | ECO |
| Capacity: | 🍴🍴 14 place settings |
| Detergent amount: | 32.5 g |
| Rinse aid dosage: | Setting 3 |

You can find information on adjusting the rinse aid dosage in the "Rinse aid" section of this booklet.

Upper basket setting:

| | |
|--------------------------------------|---------------------|
| Position: | Bottom |
| FlexCare cup rack (if available): | Left lower position |

Drying measurements: Door ajar using a block of approximately 50 mm upon completion of dry test.

Loading examples

Pictures illustrating how to load the dishwasher for each model (see data plate) are shown on the following pages.

Picture ①: Upper basket

Picture ②: Lower basket

Picture ③: Cutlery tray

Do not lower or remove the basket inserts.

Comparison tests

Capacity

14

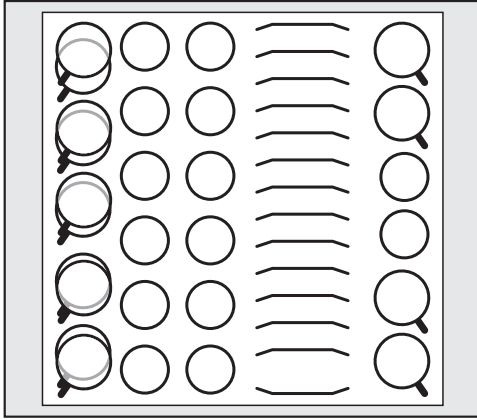

①

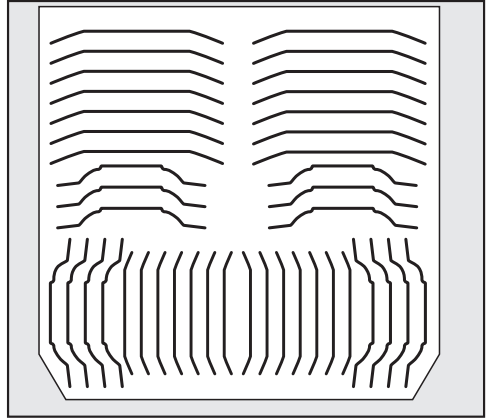

②

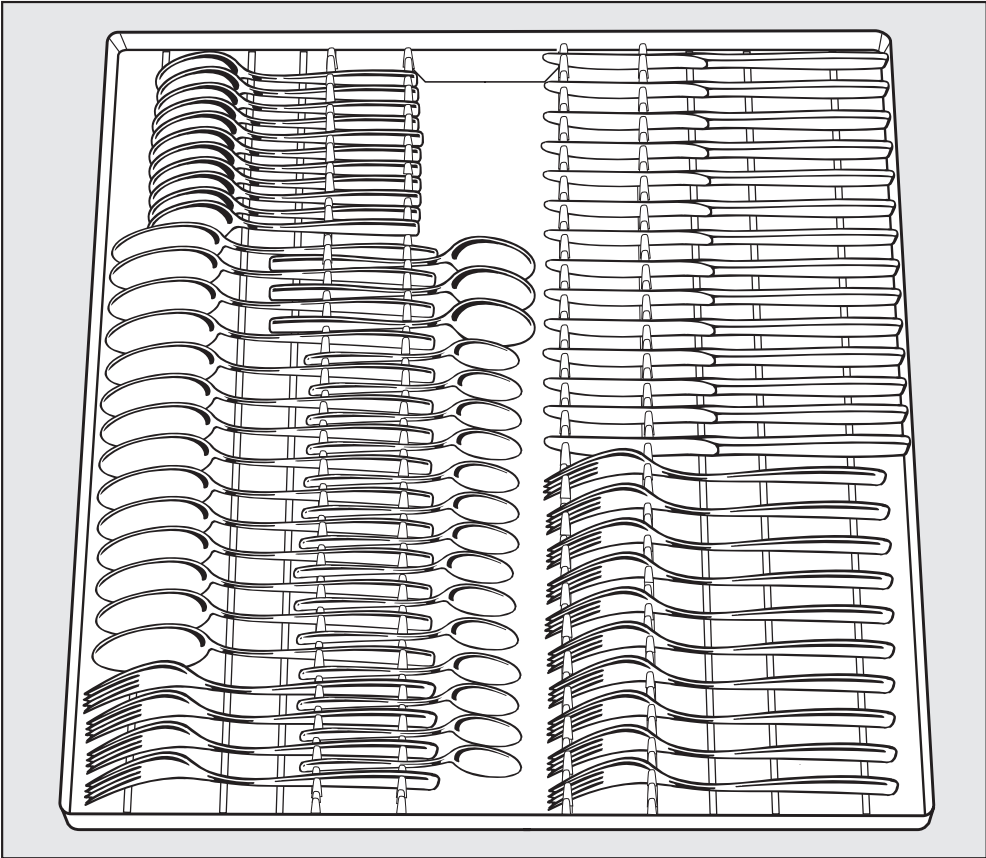

3

Detergents

Types of detergents



Damage due to unsuitable detergents.

Detergents that are not suitable for domestic dishwashers can cause damage to the dishwasher or to the load.

Only use detergents formulated for domestic dishwashers.

Modern detergents contain various active ingredients, the most important of which are:

- Water softening complexing agents to prevent calcification.
- Alkalis to aid removal of dried-on soiling.
- Enzymes to break down starch and loosen protein.
- Oxygen-based bleaching agents to remove coloured stains (e.g. tea, coffee, tomato sauce).

Most dishwasher detergents are mildly alkaline and contain enzymes and oxygen-based bleaching agents.

There are different types of detergents:

- Powder and liquid gel detergents. These detergents allow you to adjust the amount dispensed according to the size of the load and the level of soiling.
- Tablet detergents. These are suitable for most levels of soiling.

As well as the usual detergents, combination products are also available.

These contain rinse aid and water softener (reactivation salt).

Only use these combination detergents for the water hardness levels recommended by the manufacturer on the packaging.

The cleaning and drying performance of these combination detergents can vary greatly.

For optimum cleaning and drying results, use dishwasher detergent and add salt and rinse aid separately.

 Risk of chemical burns from detergent.

Dishwasher detergents can cause burning on the skin and in the eyes, nose, mouth, and throat.

Avoid contact with detergents. Do not inhale or ingest powder detergents. Do not swallow dishwasher detergent. Seek medical attention immediately if detergent has been swallowed or inhaled.

Keep detergents out of reach of children. Detergent residues could still be present in the machine. Keep children away from the dishwasher when the door is open. Do not fill the detergent dispenser until just before starting the programme and activate the door safety lock (depending on model).

Detergent dispensing

The detergent compartment holds a maximum of 50 ml.

There are marks in the detergent compartment to aid with dispensing: 20, 30, max. When the door is opened to a horizontal position, they show the approximate fill level in ml and the maximum fill height.

- Follow the detergent dosage recommended by the manufacturer on the packaging.
- Unless directed otherwise, use one detergent tab or add 20 to 30 ml of detergent to the detergent compartment, depending on the degree of soiling of the crockery.

If you use less than the recommended amount of detergent, the dishes may not get properly clean.

Some tabs may not dissolve completely when the programme *QuickPowerWash* is used.

Detergents

Adding detergent

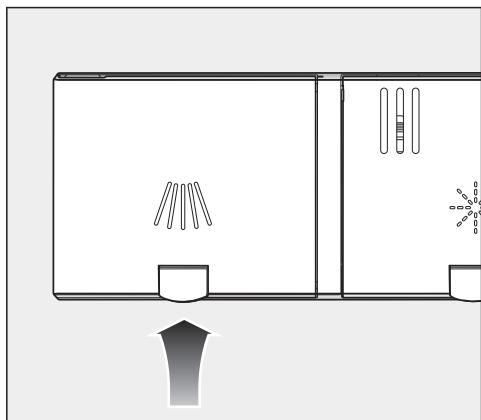

- Lift the yellow catch on the lid of the detergent compartment .

The lid will open.

The lid will also be open at the end of the programme.

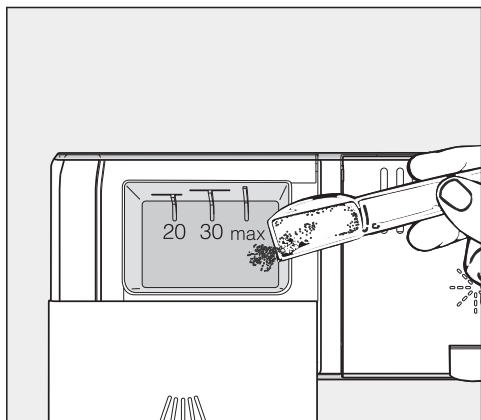

- Add the detergent to the detergent compartment.
- Slide the lid shut until you hear it click into place.

The detergent must not cause the detergent compartment lid to get stuck. This can prevent the lid from opening during the programme sequence.

Do not overfill the detergent compartment.

- Ensure that the detergent packaging is properly closed after use. This prevents the detergent from getting damp and clumping together.

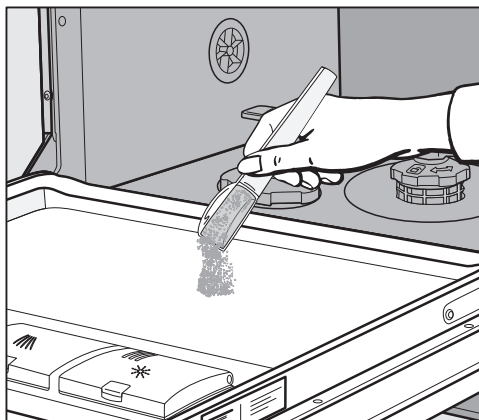

- You can also apply a small amount of detergent to the inner panel of the door in programmes that have a pre-wash stage (see “Programme chart”).

Switching on the dishwasher

- Make sure the spray arms can rotate freely.
- Close the door.
- Turn on the tap if it is turned off.
- Press the  button.

The *Start* indicator light flashes and the indicator light comes on next to the programme selected.

Selecting a programme

Choose your programme according to the type of crockery and the degree of soiling.

The different programmes and their use are described in the “**Programme chart**”.

- Use the programme selection button  to select the programme you want.

The indicator light for the selected programme will come on.

The programme duration will appear in hours and minutes in the display.

You can now select programme options (see “Programme options”).

If any programme options are selected, the appropriate indicator lights will also light up.

Operation

Display of programme duration

The duration of the programme selected appears in hours and minutes in the display before the programme begins. During the programme, the time left until the end of the programme is displayed.

The displayed duration may vary for the same programme. It is influenced by, for example, the temperature of the incoming water, the reactivation cycle of the water softener, the detergent type, the amount of crockery and how soiled it is.

When a programme is selected for the first time, the display will show the average programme duration for a cold water connection.

The programme durations shown in the “Programme chart” refer to standard test loads and temperatures.

Each time a programme is run, the control module calculates the programme duration depending on the temperature of the water taken into the dishwasher and the size of the load.

Starting a programme

- Press the *Start* button.

The programme will start.

The *Start* indicator will light up continuously.

 Risk of scalding due to hot water.

During operation, water in the dishwasher may be very hot.

Only open the door if absolutely necessary and exercise extreme caution when doing so.

At the end of the programme

The programme has ended when 0:00 appears in the display (see “Programme options - Signal tones”).

You can now open and unload the dishwasher.

The drying fan may continue to run for a few minutes at the end of the programme.



Risk of damage due to steam.

Steam from the dishwasher could damage the edges of delicate worktops when you open the door at the end of the programme if the fan is no longer running.

At the end of a programme, you can either open the door fully (do not leave it partially open) or leave it closed until you are ready to unload the crockery.

Energy management

To save energy, the dishwasher will switch off automatically 10 minutes after the last time a button is pressed or after the end of a programme.

You can switch the dishwasher back on with the  button.

The dishwasher will not switch itself off while a programme is running or if there is a fault.

Operation

Switching off the dishwasher

- The dishwasher can be switched off at any time using the  button.

Switching the dishwasher off during a programme cancels the programme.

You can also do this to stop an ongoing timer.



Risk of damage from leaking water.

Overflowing water can cause damage.

If the dishwasher is not going to be used for a longer period of time, e.g. whilst on holiday, the tap should be turned off.

Unloading the dishwasher

Dishes tend to break and chip more easily when they are hot. Allow the dishes to cool until they are comfortable enough to handle before unloading them.

The dishes will cool much faster if you open the door fully after switching off the dishwasher.

- First unload the lower basket, then the upper basket and finally the cutlery tray.

This will prevent water drops from the upper basket and cutlery tray from falling onto the dishes in the lower basket.

Interrupting a programme

A programme will be interrupted as soon as the door is opened. If the door is closed again, the programme will continue from the point it was at before the door was opened.

 Risk of scalding due to hot water.

During operation, water in the dishwasher may be very hot. Only open the door if absolutely necessary and exercise extreme caution when doing so. Before closing the door again, leave it ajar for approx. 20 seconds. This will enable the temperature in the wash cabinet to settle.

Cancelling or changing a programme

If a programme is cancelled, important programme stages may be missed.

A programme should only be cancelled in the first few minutes of the programme sequence.

If a programme has already started and you wish to cancel it, proceed as follows:

- Switch the dishwasher off with the  button.

If you would like to select another programme:

- Switch the dishwasher back on with the .
- If you have dispensed detergent manually (depending on model), check whether the detergent compartment is still closed. If the lid is already open, fill it with detergent again and close the lid.
- Select the programme you want and start it.

Options

Timer

You can set the start time of a programme. The programme start time can be delayed for between 30 minutes and 24 hours.

With a start time delay between 30 minutes and 3 hours, the delay can be set in 30-minute increments. It is set in hours for periods longer than this.

With manual detergent dispensing, the detergent can clump together if the detergent compartment is not dry, and it may not be fully rinsed out.

When using the timer function, make sure that the detergent compartment is dry before adding detergent. Wipe it dry with a cloth first if necessary. Do not use liquid detergents. These can leak out.

 Danger to health due to detergent.

To prevent children coming into contact with dishwasher detergent: Do not fill the detergent dispenser **until just before** starting the programme, i.e. before you activate the timer. Use the safety lock to secure the dishwasher door.

Activating the timer



- Switch the dishwasher on with the  button.

The *Start* indicator light will flash.

- Select the required programme.
- Press the  *Timer* button.

The most recently set time will be shown in the time display. The  *Timer* indicator light will light up.

- Set the required time after which the programme should start automatically using the  button.

If the  button is pressed and held, the time will increase automatically up to 24 hours. To start again with 0:30 hours, press the  button twice.

- Press the *Start* button.

The *Start* indicator will light up continuously.

After you have activated the timer, the display and the indicator lights will switch off after a few minutes to save energy.

Press the  button to switch the time display back on again for a few minutes.



The time up until the programme starts can be seen counting down in the display in hours for durations above 10 hours, and in minutes for durations below 10 hours.

At the end of the start delay period, the programme selected will start automatically. The time left will appear in the time display and the  *Timer* indicator light will go out.

Starting a programme before the time for the timer has elapsed:

A programme can be started before the timer has elapsed.

Proceed as follows:

- Switch the dishwasher off with the  button.
- Switch the dishwasher back on with the  button.
- Select the required programme.
- Press the *Start* button.





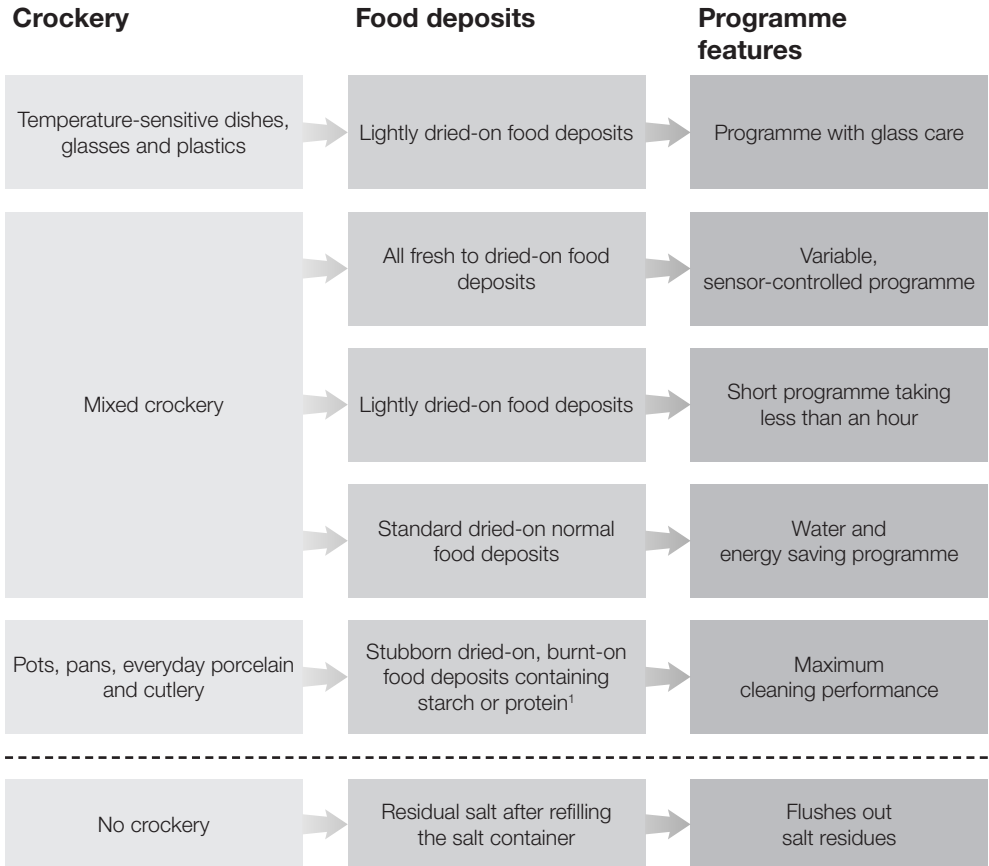







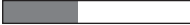

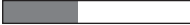

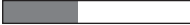

































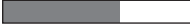

The programme will start. The *Start* indicator will light up continuously.

Guide for selecting a programme

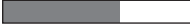

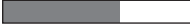
¹ Food such as potatoes, pasta, rice or stews can leave starchy deposits. Deposits containing protein can be left by food such as fried meat or fish.

Guide for selecting a programme

| Programme ² | Consumption estimate ³ | | | | | | |
|--|---|--------------------|--|-------------------|--|--------------------|--|
|  Gentle 45 °C  | <table border="1"> <tr> <td>Energy consumption</td> <td></td> </tr> <tr> <td>Water consumption</td> <td></td> </tr> <tr> <td>Programme duration</td> <td></td> </tr> </table> | Energy consumption |  | Water consumption |  | Programme duration |  |
| Energy consumption |  | | | | | | |
| Water consumption |  | | | | | | |
| Programme duration |  | | | | | | |
|  Auto 45–65 °C  | <table border="1"> <tr> <td>Energy consumption</td> <td></td> </tr> <tr> <td>Water consumption</td> <td></td> </tr> <tr> <td>Programme duration</td> <td></td> </tr> </table> | Energy consumption |  | Water consumption |  | Programme duration |  |
| Energy consumption |  | | | | | | |
| Water consumption |  | | | | | | |
| Programme duration |  | | | | | | |
|  QuickPowerWash 65 °C  | <table border="1"> <tr> <td>Energy consumption</td> <td></td> </tr> <tr> <td>Water consumption</td> <td></td> </tr> <tr> <td>Programme duration</td> <td></td> </tr> </table> | Energy consumption |  | Water consumption |  | Programme duration |  |
| Energy consumption |  | | | | | | |
| Water consumption |  | | | | | | |
| Programme duration |  | | | | | | |
|  ECO | <table border="1"> <tr> <td>Energy consumption</td> <td></td> </tr> <tr> <td>Water consumption</td> <td></td> </tr> <tr> <td>Programme duration</td> <td></td> </tr> </table> | Energy consumption |  | Water consumption |  | Programme duration |  |
| Energy consumption |  | | | | | | |
| Water consumption |  | | | | | | |
| Programme duration |  | | | | | | |
|  Intensive 75 °C  | <table border="1"> <tr> <td>Energy consumption</td> <td></td> </tr> <tr> <td>Water consumption</td> <td></td> </tr> <tr> <td>Programme duration</td> <td></td> </tr> </table> | Energy consumption |  | Water consumption |  | Programme duration |  |
| Energy consumption |  | | | | | | |
| Water consumption |  | | | | | | |
| Programme duration |  | | | | | | |
|  QuickPowerWash 65 °C  + Express  | <p>Programme duration 13 minutes, no heating up, solely for flushing out salt.</p> | | | | | | |

² The programmes can be combined with the “Express”, “Extra clean”, “Extra dry” or “Second interim rinse” programme options (see “Programme options”).

³ The estimated values may change due to the selected settings or programme options, or the conditions in which the appliance is being used.

Programme chart

| Programme | Programme sequence | | | | |
|-------------------------|--|-----------------|----------------|-------------------|--------|
| | Pre-wash | Main wash °C | Interim rinse | Final rinse °C | Drying |
| ECO ¹ | ✓ | 44 | ✓ | 45 | ✓ |
| Auto 45–65 °C | Variable programme sequence, sensor-controlled adjustment to load size and level of soiling | | | | |
| | As required | 45–65 | As required | 65 | ✓ |
| Gentle 45 °C | ✓ | 45 | ✓ | 70 | ✓ |
| QuickPowerWash 65 °C | - | 65 | ✓ | 65 | ✓ |
| Intensive 75 °C | ✓ | 75 | ✓ | 70 | ✓ |

¹ This programme is the most efficient in terms of its combined energy and water consumption for cleaning dishes with a normal level of soiling.

Programme chart

| Consumption ² | | | | |
|--------------------------|--------------------------|-------------------------|--------------------------|--------------------------|
| Electricity | | Water | Time | |
| Cold water | Hot water | Litres | Cold water | Hot water |
| kWh | kWh | | h:min | h:min |
| 0.60/0.59 ³ | 0.34/0.33 ³ | 9.2 | 3:26/3:27 ³ | 3:18/3:18 ³ |
| 0.75–1.45 ^{4,5} | 0.45–0.80 ^{4,5} | 6.0–16.0 ^{4,5} | 1:48–3:33 ^{4,5} | 1:39–3:14 ^{4,5} |
| 1.10 | 0.55 | 13.5 | 2:29 | 2:12 |
| 1.20 | 0.70 | 11.0 | 0:58 | 0:58 |
| 1.55 | 0.95 | 14.0 | 3:00 | 2:46 |

² The values for the *ECO* programme were calculated under standardised testing conditions. Values for the remaining programmes were calculated under comparable testing conditions.

In practice, the selected settings, programme options or use conditions may result in different values.

³ Dishwashers with cutlery tray/cutlery basket

⁴ Minimum value: half load with light soiling

⁵ Maximum value: full load with heavy soiling

Programme options

Express

The  *Express* programme option reduces the programme duration.

In order to achieve optimum cleaning results, the temperature, and therefore the energy consumption, will increase with this option.

The time by which the programme duration is shortened varies according to the selected programme.

Selecting the  *Express* programme option may take precedence over other selected options.

When used in combination with the *QuickPowerWash* programme, the  *Express* option results in a rinse cycle designed solely for the purpose of flushing out the cabinet to remove salt solution that leaked out after refilling the salt reservoir.

- Switch the dishwasher on with the  button.

The *Start* indicator light will flash.

- Select a different programme if required.
- Press the  *Express* button.



The  *Express* indicator light will come on if the programme option is available for the programme selected.

- Press the *Start* button to start the programme.

The selected programme option will remain active for that particular programme until the selection is changed.

Switching off the refill reminders

If you only ever use combination detergent products containing salt and rinse aid in your dishwasher, you can switch off both refill reminders if you wish.

- Switch the dishwasher off with the  button, if it is switched on.
- Press the *Start* button in and, **whilst holding it in**, switch the dishwasher on using the  button. Keep the *Start* button pressed in for at least 4 seconds until the *Start* indicator light comes on.

If this does not happen, start the procedure from the beginning again.

- Press the \gt programme selection button 9 times.

The left programme indicator light will flash rapidly 9 times at intervals.

The flashing sequence in the time display will show whether the refill reminders are switched on or off.

- P 1: Refill reminders activated
- P 0: Refill reminders deactivated
- Press the *Start* button to change the setting.

The setting is now stored in memory.

- Switch the dishwasher off with the  button.

Please make sure that if you stop using combination detergents, you refill the dishwasher salt and rinse aid. Switch the refill reminders back on.



Programme options

Extra clean

You can choose this programme option to increase the cleaning performance of the programmes.

If you activate this programme option, the programme running times and the main wash temperatures will increase. The water and energy consumption may increase.

If this function is activated, it will be applied to all programmes until it is deactivated.

- Switch the dishwasher off with the  button, if it is switched on.
- Press the *Start* button in and, **whilst holding it in**, switch the dishwasher on using the  button.
Keep the *Start* button pressed in for at least 4 seconds until the *Start* indicator light comes on.

If this does not happen, start the procedure from the beginning again.

- Press the \gt programme selection button 10 times.

The left programme indicator light will emit 1 long flash at intervals.

The flashing sequence in the time display indicates whether the Extra clean programme option is activated or not:

- P 1: Extra clean is activated
- P 0: Extra clean is deactivated

- Press the *Start* button to change the setting.

The setting is now stored in memory.



- Switch the dishwasher off with the  button.

Extra dry

You can select this programme option in order to increase the programme drying performance.

If you activate this programme option, the programme running times and final rinse temperatures will increase. The energy consumption may increase.

If this function is activated, it will be applied to all programmes until it is deactivated.

- Switch the dishwasher off with the  button, if it is switched on.
- Press the *Start* button in and, **whilst holding it in**, switch the dishwasher on using the  button. Keep the *Start* button pressed in for at least 4 seconds until the *Start* indicator light comes on.

If this does not happen, start the procedure from the beginning again.

- Press the > programme selection button 11 times.

The left programme indicator light will emit 1 long flash and 1 short flash at intervals.

The flashing sequence in the time display indicates whether the Extra dry programme option is activated or not:

- P 1: Extra dry is activated
- P 0: Extra dry is deactivated

- Press the *Start* button to change the setting.



The setting is now stored in memory.

- Switch the dishwasher off with the  button.

Programme options

Factory default settings

If you have altered any settings, you can reset them back to the factory default settings.

- Switch the dishwasher off with the  button, if it is switched on.
- Press the *Start* button in and, **whilst holding it in**, switch the dishwasher on using the  button. Keep the *Start* button pressed in for at least 4 seconds until the *Start* indicator light comes on.

If this does not happen, start the procedure from the beginning again.

- Press the \gt programme selection button 19 times.

The left programme indicator light will emit 1 long flash and 9 short flash at intervals.

The flashing sequence in the time display indicates whether the setting deviates from the factory default:

- $P \ 1$: All values are factory default settings.
- $P \ \square$: At least one setting has been changed.

- To reset the dishwasher to the factory default settings, press the *Start* button.

The setting is now stored in memory.

- Switch the dishwasher off with the  button.

Check the condition of your dishwasher regularly (approx. every 4–6 months). This way, faults and problems can be avoided.

 Damage caused by unsuitable cleaning agents.

All surfaces of this appliance are susceptible to scratching. Contact with unsuitable cleaning agents can alter or discolour all surfaces.

Only use cleaning agents formulated for use on the relevant surfaces.

Cleaning the wash cabinet

The wash cabinet is largely self-cleaning, provided that the correct amount of detergent is always used.

If, despite this, limescale or grease deposits build up in the cabinet, these can be removed with a proprietary dishwasher cleaner (available from Miele or the Miele webshop, see “Optional accessories – Appliance care”). Follow the instructions on the product packaging.

The frequent use of low-temperature wash programmes (< 50 °C) increases the risk of contamination and odours inside the wash cabinet. Run the *Intensive 75 °C* programme once a month to clean the wash cabinet and prevent odours from developing.

- Clean the filters in the wash cabinet regularly.

Cleaning and care

Cleaning the door and the door seal

The door seal and the sides of the dishwasher door are not accessed and cleaned by the spray arm jets. As a result, mould can develop here.

- Wipe the door seals regularly with a damp cloth to remove food deposits.
- Wipe off any food or drink residues which may have dripped onto the sides of the dishwasher door before closing it.

Cleaning the control panel

- The control panel should **only** be wiped with a damp cloth.

Cleaning the appliance front



Damage due to soiling.

Soiling that is left too long might become impossible to remove and could cause the external surfaces to alter or discolour.

It is therefore best to remove any soiling immediately.

- Clean the front with a soft sponge and a solution of warm water and a little washing-up liquid. After cleaning, wipe the front dry using a soft cloth.
A clean, damp microfibre cloth (such as the Original Miele all purpose microfibre cloth) without detergent can also be used.

To avoid damaging the external surfaces, do not use the following:

- cleaning agents containing soda, ammonia, acids or chlorides
- cleaning agents containing descaling agents
- abrasive cleaning agents, e.g. powder cleaners and cream cleaners
- solvent-based cleaning agents
- stainless steel cleaning agents
- dishwasher cleaners
- oven cleaners or sprays
- glass cleaning agents
- hard, abrasive brushes or sponges, e.g. pot scourers, brushes, or sponges which have been previously used with abrasive cleaning agents
- dirt eraser sponges
- sharp metal scrapers
- steel wool or metal scourers
- steam cleaners

Cleaning the spray arms

Particles of food can get stuck in the spray arm jets and bearings. The spray arms should therefore be inspected regularly (approx. every 2–4 months).

Never run a wash programme without using the spray arms.

⚠ Damage due to soiling entering the circulation system.

Without filters, soiling can enter the circulation system and cause a blockage.

Do not run a wash programme without the lower spray arm or without the filters fitted.

When cleaning the filters and spray arms, make sure that coarse soiling cannot get into the circulation system.

- Switch the dishwasher off.

Removing the cutlery tray (if present)

In order to be able to remove the upper spray arm, you first have to remove the cutlery tray (if present).

- Pull out the cutlery tray.

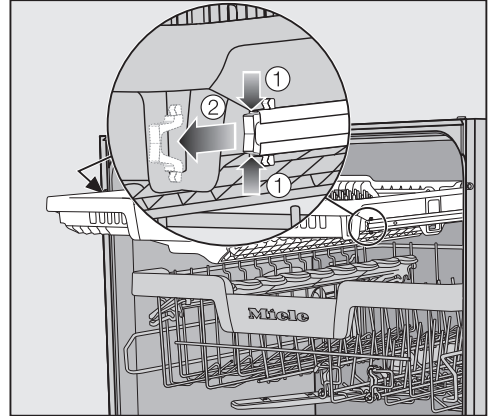

- Press the rail safety clips on both sides of the cutlery tray together ① and remove the safety clips ②.
- Take out the cutlery tray completely.

Cleaning and care

Removing the upper spray arm

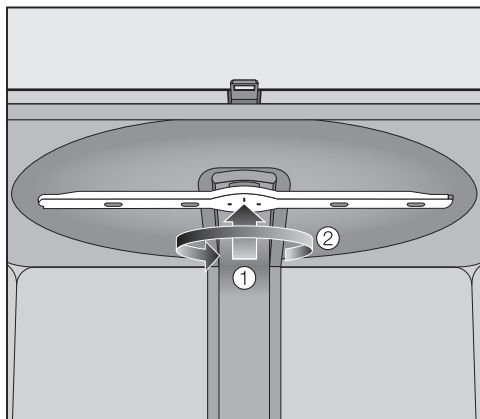

- Push the upper spray arm upwards ① to engage the inner ratchet. Then unscrew the spray arm by rotating the screw thread anti-clockwise (when viewed from below) ②.

Removing the middle spray arm

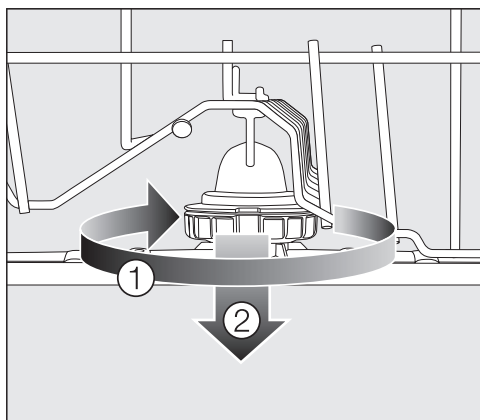

- Rotate the screw thread of the middle spray arm clockwise (overhead perspective) ① (see diagram) and remove the spray arm ②.

Removing the lower spray arm

- Remove the lower basket.

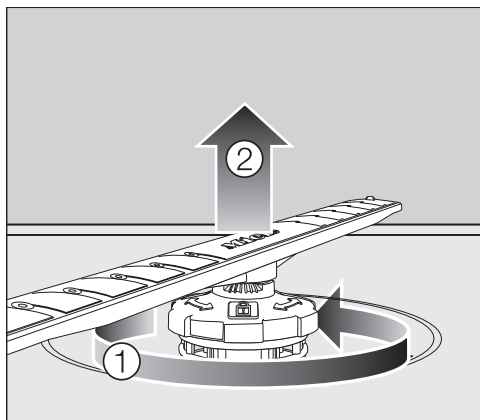

- Rotate the screw thread of the lower spray arm anti-clockwise ① and pull the spray arm upwards to remove ②.

Cleaning the spray arms

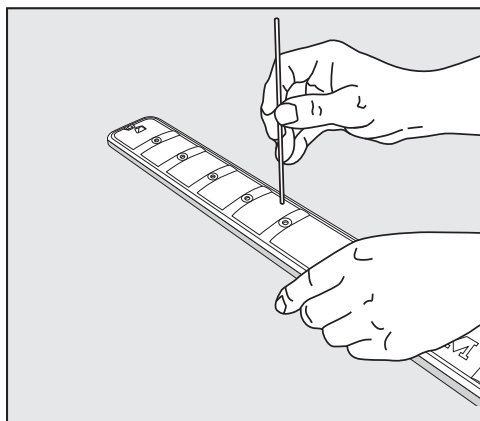



- Use a pointed object to push food particles stuck in the jets into the spray arm.
- Rinse the spray arm thoroughly under running water.

Refitting the spray arms

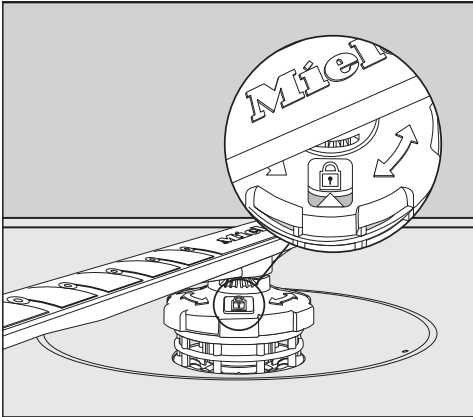
- Reinstall the upper spray arm and tighten it by hand.
- Reinstall the middle spray arm.
- Refit the lower spray arm and ensure that the filter combination lies flat in the base of the wash cabinet.



- Rotate the screw thread of the lower spray arm clockwise until the arrow in the viewing window points to the lock symbol .
- Make sure the spray arms can rotate freely.

 Damage due to soiling entering the circulation system.

The lower spray arm is used to secure the filter combination. Without filters, coarse soiling can enter the circulation system and cause a blockage.

Do not run a wash programme without the lower spray arm or without the filters fitted.

Inserting the cutlery tray (if present)

- Slide the cutlery tray back onto the rails from the front.
- Replace the safety clips in the rails on both sides of the cutlery tray.

Cleaning and care

Checking the filters in the wash cabinet

The filter combination in the base of the wash cabinet retains coarse soiling from the suds solution. This prevents soiling getting into the circulation system and re-entering the wash cabinet through the spray arms.

 Damage due to soiling entering the circulation system.

Without filters, soiling can enter the circulation system and cause a blockage.

Do not run a wash programme without the lower spray arm or without the filters fitted.

When cleaning the filters and spray arms, make sure that coarse soiling cannot get into the circulation system.

The filters can become clogged by soiling that collects over time. The level of soiling and the time it takes before the filters need cleaning will vary depending on use.

- Monitor the condition of the filter combination regularly and clean it if necessary.

Cleaning the filters

- Switch the dishwasher off.
- Remove the lower spray arm (see “Cleaning and care - Cleaning the spray arms”).
- Before removing the filter combination, remove any coarse soiling to prevent it from entering the circulation system.

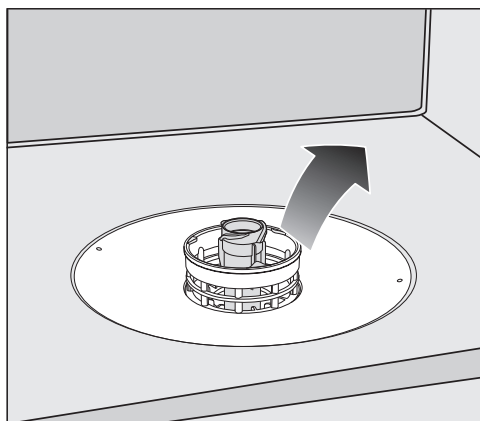

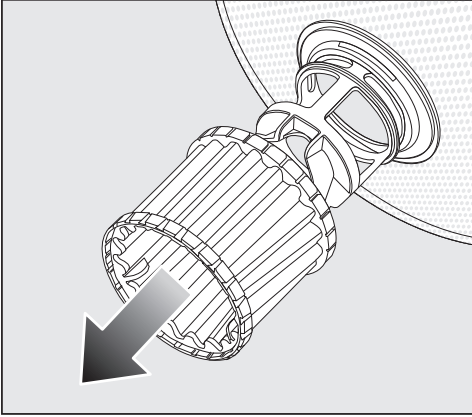

- Remove the filter combination.

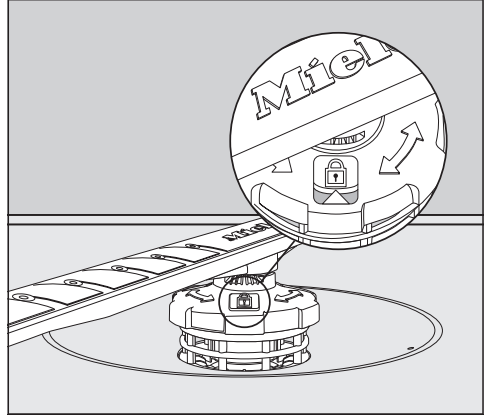

- In order to clean the inside of the filter, pull the microfilter downwards and away from the filter combination.
- Rinse all the parts under running water. If necessary, use a soft cleaning brush to remove soiling.
- Push the microfilter back onto the filter combination.
- Refit the filter combination so that it lies flat in the base of the wash cabinet.
- Refit the lower spray arm to the filter combination using the screw thread.



- Rotate the screw thread clockwise until the arrow in the viewing window points to the lock symbol .

 Damage due to soiling entering the circulation system.

The lower spray arm is used to secure the filter combination. Without filters, coarse soiling can enter the circulation system and cause a blockage.

Do not run a wash programme without the lower spray arm or without the filters fitted.

Cleaning and care

Cleaning the water inlet filter

A filter is incorporated in the screw thread to protect the water inlet valve. If the filter is soiled, insufficient water flows into the wash cabinet.

 Risk of electric shock.

The plastic housing of the water connection contains an electrical valve.

The housing must not be dipped in water.

- Disconnect the dishwasher from the power supply.
To do this, switch off at the socket and withdraw the plug.
- Turn off the tap.
- Unscrew the water inlet valve.

- Carefully remove the seal from the threaded union.
- Using combination or pointed pliers, take hold of the plastic filter bar and remove the filter.
- Rinse the filter under running water.
- Reassemble in reverse order.

Screw the threaded union securely back onto the tap. Slowly turn on the tap. If water drips out, tighten the connection.

Never forget to put the filter back in place after cleaning.

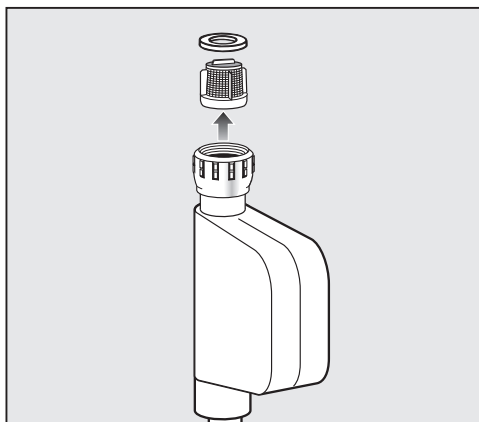

Cleaning the drain pump

If water remains in the wash cabinet after the end of a programme, the water has not been pumped away. The drain pump may be blocked by foreign objects. These foreign objects are easy to remove.

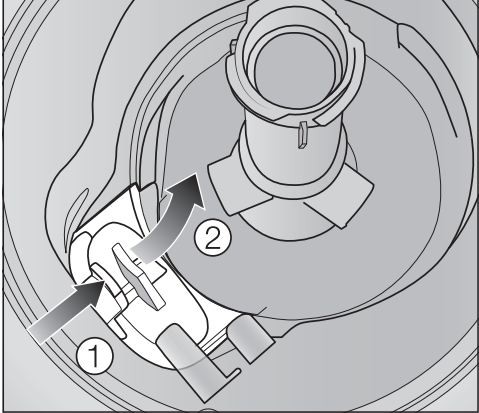
- Disconnect the dishwasher from the power supply.
To do this, switch off at the socket and withdraw the plug.
 - Take the filter combination out of the wash cabinet (see “Cleaning and care - Cleaning the filters”).
 - Scoop the water out of the wash cabinet using a suitable container or utensil.
- 
- Press the catch of the drain pump cover inwards ①.
 - Tip the cover inwards until it is released ②.
 - Rinse the cover thoroughly under running water and remove all foreign objects.

Cleaning and care

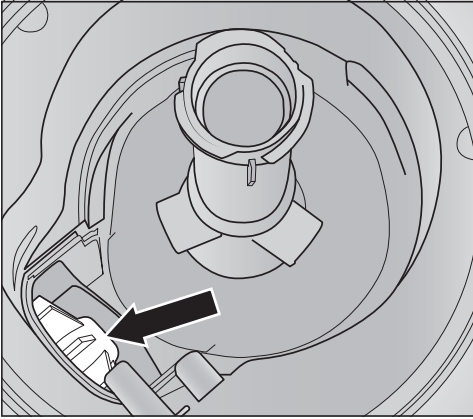

The drain pump (see arrow) is underneath the cover.

! Risk of injury from glass splinters.

It is especially difficult to see glass splinters in the drain pump.

Take care when cleaning the drain pump.

- Carefully remove all foreign objects from the drain pump. Check the drain pump impeller by manually turning it. You will feel a little resistance when you turn the impeller.
- Refit the cover in the reverse order of removing it.

Ensure that the catch engages correctly.

! Damage caused by incorrect cleaning.

The components are delicate and can be damaged during cleaning. Take care when cleaning the drain pump.

Problem solving guide

With the help of the following guide, minor faults in the performance of the appliance, some of which may result from incorrect operation, can be remedied without contacting Miele. This will save you time and money because you won't need a service call.

Please note that a call-out charge will be applied to unnecessary service visits where the problem could have been rectified as described in these operating instructions.

This section only lists faults that you can remedy yourself. All other faults are shown in  Fault FXX.

Technical problems



| Problem | Possible cause and remedy |
|--|--|
| The control panel remains dark after the dishwasher has been switched on with the button.  | The dishwasher is not plugged in or the socket is not switched on. <ul style="list-style-type: none">■ Insert the plug and switch on at the socket. |
| | The circuit breaker has tripped. <ul style="list-style-type: none">■ Reset the circuit breaker in the mains fuse box (see data plate for minimum fuse rating).■ If the circuit breaker trips again, call Miele. |
| The dishwasher stops during a programme. | The circuit breaker has tripped. <ul style="list-style-type: none">■ Reset the circuit breaker in the mains fuse box (see data plate for minimum fuse rating).■ If the circuit breaker trips again, call Miele. |

Problem solving guide

Fault messages

| Problem | Possible cause and remedy |
|---|--|
| The display shows a fault number that is not listed below. | There may be a technical fault. <ul style="list-style-type: none">■ Switch the dishwasher off with the  button.■ Switch the dishwasher back on after a few seconds.■ Restart the desired programme. If the indicator lights flash again, there is a technical fault. <ul style="list-style-type: none">■ Switch the dishwasher off.■ Turn off the tap.■ Call Miele. |
| Fault <i>F70</i>: The drain pump may still be running, even with the door open. | The Waterproof system has reacted. <ul style="list-style-type: none">■ Switch the dishwasher off.■ Turn off the tap.■ Call Miele. |
| All of the programme selection indicator lights are flashing. Fault number <i>F78</i> appears in the time display. | Circulation pump fault. <ul style="list-style-type: none">■ Switch the dishwasher off.■ Switch the dishwasher back on.■ Restart the desired programme. If the fault message appears again, there is a technical fault. <ul style="list-style-type: none">■ Switch the dishwasher off.■ Turn off the tap.■ Call Miele. |

Water intake fault

| Problem | Possible cause and remedy |
|--|---|
| <p>The  indicator light flashes on and off. <i>F</i> and <i>173</i> appear alternately in the time display.</p> | <p>The tap is turned off.</p> <ul style="list-style-type: none"> ■ Turn on the tap fully. |
| <p>The dishwasher stops during a programme. The  indicator light is flashing. The fault number <i>F12</i> or <i>F13</i> appears in the display.</p> | <p>Before rectifying the problem, you must:</p> <ul style="list-style-type: none"> ■ Switch the dishwasher off with the  button. <p>Water intake is restricted.</p> <ul style="list-style-type: none"> ■ Turn on the tap fully and start the programme again. ■ Clean the filter in the water inlet (see “Cleaning and care – Cleaning the water inlet filter”). ■ The water connection pressure is lower than 50 kPa. Seek professional advice. ■ The on-site connection for the water drainage may be too low and you will need to vent the water drainage (see “Installation – Drainage”). |
| <p>The dishwasher stops during a programme. The warning buzzer is sounding. Fault number <i>F18</i> appears in the time display.</p> | <p>A technical fault has occurred.</p> <ul style="list-style-type: none"> ■ Switch the dishwasher off. ■ Turn off the tap. ■ Call Miele. |

Problem solving guide

Water drainage fault

| Problem | Possible cause and remedy |
|--|---|
| <p>The dishwasher stops during a programme. The  indicator light is flashing. Fault number <i>F11</i> appears in the time display.</p> | <p>Before rectifying the problem, you must:</p> <ul style="list-style-type: none">■ Switch the dishwasher off. <p>Water drainage fault. There might be water in the wash cabinet.</p> <ul style="list-style-type: none">■ Clean the filter combination (see “Cleaning and care – Cleaning the filters”).■ Clean the drain pump (see “Cleaning and care – Cleaning the drain pump”).■ Remove any kink or loop in the drain hose. |

General problems with the dishwasher

| Problem | Possible cause and remedy |
|--|---|
| The indicator lights and time display are dark. | The dishwasher has switched off automatically to save energy. <ul style="list-style-type: none"> ■ Switch the dishwasher back on with the  button. |
| Detergent residue is left in the detergent compartment at the end of a programme. | The detergent compartment was still damp when detergent was added. <ul style="list-style-type: none"> ■ Only add the detergent when the detergent compartment is dry. |
| The detergent compartment lid cannot be closed. | Residual detergent is blocking the catch. <ul style="list-style-type: none"> ■ Remove the residual detergent. |
| At the end of a programme there is a film of moisture on the inside of the door and possibly on the interior walls. | This is part of the normal function of the drying system. The moisture will dissipate after a short while. |
| Water remains in the wash cabinet at the end of a programme. | Before rectifying the problem, you must: <ul style="list-style-type: none"> ■ Switch the dishwasher off. |
| | The filter combination in the wash cabinet is clogged. <ul style="list-style-type: none"> ■ Clean the filter combination (see “Cleaning and care – Cleaning the filters”). |
| | The drain pump is blocked. <ul style="list-style-type: none"> ■ Clean the drain pump (see “Cleaning and care – Cleaning the drain pump”). |
| | The drain hose is kinked. <ul style="list-style-type: none"> ■ Remove any kinks from the drain hose. |

Problem solving guide

Noises

| Problem | Possible cause and remedy |
|--|--|
| Knocking noise in the wash cabinet. | A spray arm is knocking against a crockery piece. ■ Carefully open the door and rearrange the wash items that are obstructing the spray arm. |
| Rattling noise in the wash cabinet. | Items of crockery are not secure in the wash cabinet. ■ Carefully open the door and rearrange the wash items so that they sit securely. |
| | There is a foreign object (e.g. glass shard) in the drain pump. ■ Remove the foreign object from the drain pump (see “Cleaning and care - Cleaning the drain pump”). |
| Knocking noise in the water pipes | This may be caused by the on-site installation or the cross-section of the piping. ■ However, this will not affect the functioning of the dishwasher in any way. If in doubt, contact a suitably qualified plumber. |

Unsatisfactory cleaning result

| Problem | Possible cause and remedy |
|--|---|
| <p>The dishes are not clean.</p> | <p>The items were not loaded correctly.</p> <ul style="list-style-type: none"> ■ See notes under “Loading the dishwasher”. |
| | <p>The programme was not thorough enough.</p> <ul style="list-style-type: none"> ■ Select a more intensive programme (see “Programme chart”). ■ Activate the Extra clean function (see “Programme options – Extra clean”). |
| | <p>Not enough detergent was dispensed during manual detergent dispensing.</p> <ul style="list-style-type: none"> ■ Use more detergent, or change your detergent. |
| | <p>Items are blocking the path of the spray arms.</p> <ul style="list-style-type: none"> ■ Carry out a rotation check and if needed rearrange the items so that the spray arms can rotate freely. |
| | <p>The filter combination in the base of the wash cabinet is not clean or not correctly fitted. This may have caused the spray arm jets to become blocked.</p> <ul style="list-style-type: none"> ■ Clean and/or fit the filter combination correctly. ■ Clean the spray arm jets if necessary (see “Cleaning and care - Cleaning the spray arms”). |
| <p>There are smears on glassware and cutlery. There is a bluish sheen on the surface of glassware. The film can be wiped off.</p> | <p>The rinse aid dosage is set too high.</p> <ul style="list-style-type: none"> ■ Reduce the dosage (see “Using for the first time – Rinse aid”). |

Problem solving guide

| Problem | Possible cause and remedy |
|---|--|
| Dishes are not dry or cutlery and glasses are blotchy. | The amount of rinse aid may be insufficient, or the rinse aid reservoir is empty. ■ Replenish the rinse aid, increase the dosage, or change the brand of rinse aid (see “Using for the first time - Rinse aid”). |
| | Dishes were taken out of the wash cabinet too soon. ■ Leave dishes in longer (see “Operation - Unloading the dishwasher”). |
| | The duration of the drying phase for the selected programme is not sufficient for the crockery (particularly for plastic crockery). ■ Select the Extra dry programme option (see “Programme options – Extra dry”). |
| | You have used combination products that have insufficient drying performance. ■ Switch to another detergent or add rinse aid (see “Using for the first time - Rinse aid”). |
| Glassware has a brown or blue tinge. The film cannot be wiped off. | Ingredients from the detergent have formed a deposit. ■ Switch to another detergent straight away. |
| Glassware is dull and discoloured. The film cannot be wiped off. | The glassware is not dishwasher safe. The surface has altered. ■ There is no remedy. Purchase glassware which is dishwasher safe. |
| Tea or lipstick stains have not been completely removed. | The wash temperature of the selected programme was too low. ■ Select a programme with a higher wash temperature. |
| | The bleaching effect of the detergent is too low. ■ Change your detergent. |
| Plastic items are discoloured. | Natural dyes, e.g. from carrots, tomatoes or tomato sauce may be the cause. The amount of detergent used or its bleaching effect was not sufficient to deal with natural dyes. ■ Use more detergent (see “Detergents”). Parts that are already discoloured will not revert to their original colour. |

Problem solving guide

| Problem | Possible cause and remedy |
|--|--|
| <p>White residue is visible on the dishware. Clouding has occurred on glassware and cutlery. The film can be wiped off.</p> | <p>Not enough rinse aid was added.</p> <ul style="list-style-type: none"> ■ Increase the dosage (see “Using for the first time – Rinse aid”). |
| | <p>The salt reservoir is empty.</p> <ul style="list-style-type: none"> ■ Fill the salt reservoir (see “Using for the first time - Dishwasher salt”). |
| | <p>The salt reservoir cap has not been screwed on correctly.</p> <ul style="list-style-type: none"> ■ Replace it, making sure that it screws back on correctly. |
| | <p>Unsuitable combination detergents were used.</p> <ul style="list-style-type: none"> ■ Change your detergent. If using tabs or powder detergent, do not choose combination products and ensure you refill the reactivation salt and rinse aid. |
| | <p>The water softener is programmed to a setting which is too low for the water hardness level.</p> <ul style="list-style-type: none"> ■ Programme the water softener to a higher water hardness level (see “Using for the first time – Water softener”). |
| <p>There are rust stains on cutlery.</p> | <p>The affected items are not corrosion resistant.</p> <ul style="list-style-type: none"> ■ There is no remedy. Purchase cutlery which is dishwasher safe. |
| | <p>A programme was not run after dishwasher salt was added. Traces of salt have gotten into the normal wash cycle.</p> <ul style="list-style-type: none"> ■ Always run the ☺ 65 °C <i>QuickPowerWash</i> programme with the 🌀 <i>Express</i> option selected and without any load in the dishwasher immediately after adding dishwasher salt. |
| | <p>The salt reservoir cap has not been screwed on correctly.</p> <ul style="list-style-type: none"> ■ Replace it, making sure that it screws back on correctly. |

Service

Contact in case of fault

In the event of any faults which you cannot remedy yourself, please contact Miele.

You can book a Miele customer service call-out online at www.miele.com.au/service or www.miele.co.nz/service.

Contact information for Miele can be found at the end of this booklet.

Please quote the model and serial number of your appliance when contacting Miele. This information can be found on the data plate.

The data plate is located on the right side of the door.

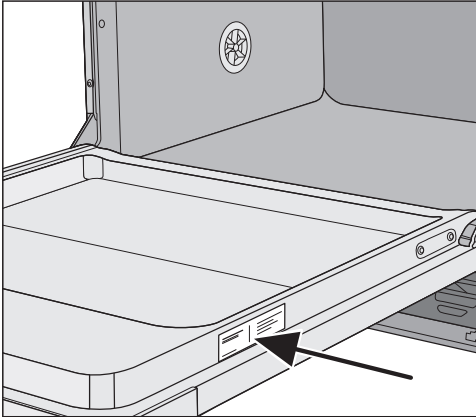

Warranty

The manufacturer's warranty for this appliance is 2 years.

For further information, please refer to your warranty booklet.

Dishwasher detergent, rinse aid, and cleaning and care products are available for this dishwasher, as are optional accessories. All the products have been designed for Miele appliances.

These and many other useful products can be ordered from the Miele online store or a Miele Experience Centre.

Detergents

With your Miele dishwasher you have chosen excellent quality and performance. To achieve optimum results all the time, it is important to use the right dishwasher detergents. Not all off-the-shelf products deliver the same results in all dishwashers.

For this reason Miele offers dishwasher products specifically designed for Miele appliances.

Detergent tablets

- sparkling results even with stubborn food deposits
- combination product with other functions such as rinse aid, salt, and glass protective additives
- phosphate-free – environmentally friendly
- water-soluble wrapping – no need to unwrap

Powder detergent

- with active oxygen for thorough cleaning
- with enzymes which are effective even at low-temperatures
- with glass protective formula against corrosion

Rinse aid

- for sparkling glasses
- helps dishes to dry
- with glass protective formula against corrosion
- specially designed cap for accurate and easy dispensing

Dishwasher salt

- prevents limescale deposits on dishes and in the appliance
- extra coarse-grained

Optional accessories

Appliance care

Miele cleaning and care products provide optimum care for your dishwasher.

IntenseClean

- for use with the Maintenance programme (depending on model) without detergent dispensing
- cleans the dishwasher effectively and thoroughly
- removes grease, bacteria and associated unpleasant odours
- ensures excellent dishwashing results

Descaling agent

- removes heavy limescale deposits
- mild and gentle with natural citric acid

DishClean

- removes odours, limescale and light deposits
- maintains the elasticity and leak tightness of the seals

The Miele Waterproof system

Provided that your dishwasher has been installed correctly, the Miele Waterproof system will protect you from water damage throughout its lifetime.

Water intake

 Danger to health due to wash water.

Water in the dishwasher must not be used as drinking water.

Do not drink any water from the dishwasher.

 Health risk and risk of damage due to contaminated incoming water.

The quality of the water used must correspond to the drinking water specification of the country in which the dishwasher is being operated.

Connect the dishwasher to a drinking water supply.

The dishwasher may be connected to cold or hot water (up to max. 60 °C). If energy-saving water heating sources, such as a solar water heating system, are used, we recommend connecting to the hot water. This saves both time and electricity costs. Hot water is used in all programmes.

The intake hose is approx. 1.5 m long.

Installation

A tap with a 3/4" male thread must be provided on site. If this type of tap is not available, only a qualified plumber may connect the dishwasher to the household water supply.

The dishwasher must be connected to a mains water supply in accordance with current local and national safety regulations.

The water connection pressure needs to be between 50 and 1000 kPa. If the water pressure is lower than this, the  indicator light flashes (see "Problem solving guide - Water intake fault"). If the water pressure is too high, a pressure reducing valve must be fitted.

 Risk of damage from leaking water.

The threaded union is subject to water pressure. Water leaking from it can cause damage.

Turn on the tap slowly and check for leaks. Correct the position of the seal and union if necessary.

 Risk of damage due to excessive pressure.

A brief increase in the water pressure can damage components of the dishwasher.

This dishwasher must only be operated when it is connected to a fully vented plumbing system.

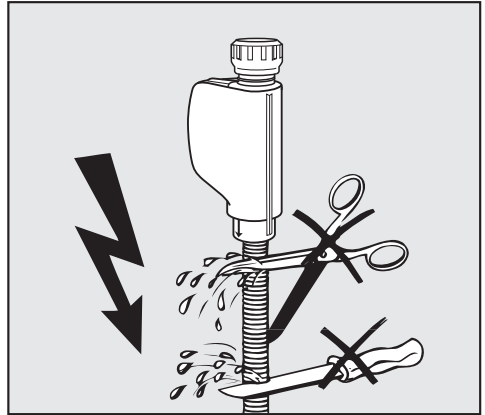

 Risk of electric shock.

There are electrical components in the water inlet hose.

The inlet hose must not be shortened or damaged in any way (see illustration).

Drainage

The appliance drainage system is fitted with a non-return valve, which prevents dirty water from flowing back into the dishwasher via the drain hose.

The dishwasher is supplied with approx. 1.5 m of flexible drain hose with an internal diameter of 22 mm.

The hose can be extended using a connection piece to attach a further length of hose. The drainage length must not be longer than 4 m and the delivery head no higher than 1 m.

If the hose is to be directly connected to the drainage outlet on site, use the supplied hose clip (see the installation plan).

The hose can be directed to the left or the right of the appliance.

The on-site connector for the drain hose can be adapted to different hose diameters. If the connector extends too far into the drain hose, it must be shortened. Otherwise, the drain hose can become clogged.

The drain hose must not be shortened.

Lay the drain hose so that it does not kink and is not being subjected to pressure or being tugged.

 Risk of damage from leaking water.

Overflowing water can cause damage.

After using the appliance for the first time, make sure that the water drain does not leak.

Installation

Venting the water drainage

If the on-site drainage connection is situated lower than the guide for the rollers of the lower basket in the door, the drainage system must be vented. Otherwise, a siphoning effect during a programme can cause the appliance to empty itself of water.

- Open the dishwasher door fully.

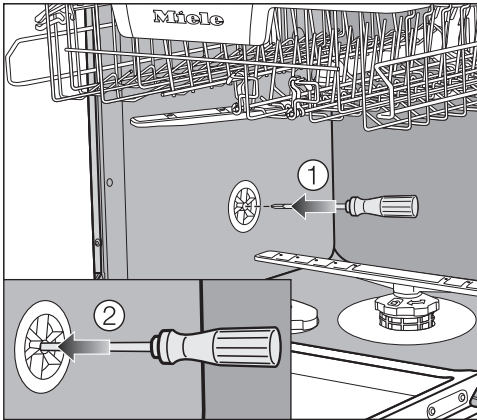

- Remove the lower basket.
- Insert a screwdriver into the middle opening of the vent valve in the left wash cabinet wall ①.
- Press the screwdriver further into the opening and push it through the membrane ② behind.

The vent opening for the water drain is now open.

The dishwasher is supplied with a mains cable with moulded plug ready for connection to an earthed socket.

 Danger of suffocation due to gases.

Connecting the dishwasher to a multi-socket plug adapter or to an extension lead can overload the cable. This can cause a fire, releasing toxic gases.

Do not use an extension lead or multi-socket plug adapter.

 Risk of fire from overheating.

Connecting the dishwasher to a multi-socket plug adapter or to an extension lead can overload the cable.

Do not use an extension lead or multi-socket plug adapter.

The socket must be easily accessible after the dishwasher has been installed. If the switch is not accessible after installation, an additional means of disconnection must be provided for all poles.

If the connection cable is damaged, it must only be replaced with a specific connection cable of the same type (available from Miele) in order to avoid a hazard. For safety reasons, such replacement may only be carried out by a suitably qualified and competent technician or by Miele.

Do not connect the dishwasher to a stand-alone inverter such as those used with an autonomous energy source (e.g. **solar power**). When the appliance is switched on, power surges could result in a safety switch-off. This could damage the electronics.

The dishwasher must not be used with so-called **energy-saving devices** either. These reduce the amount of energy supplied to the appliance, causing it to overheat.

Before connecting the appliance, check that the connection data on the data plate (voltage, frequency, and fuse rating) match the mains electricity supply and that the installed socket system matches that of the dishwasher. If in any doubt, consult a qualified electrician.

For technical data see the data plate located on the right side of the door.

The electrical installation and all electrical work must be carried out by a suitably qualified and competent person, in strict accordance with national and local safety regulations. For extra safety, it is advisable to install a residual current device (RCD) with a trip current of 30 mA. Ensure power is not supplied to the appliance until after the installation has been completed. Connection should be made via a suitable switched socket.

Technical data

Technical data

| Dishwasher model | Standard | XXL |
|----------------------------------|------------------------------------|------------------------------------|
| Height of freestanding appliance | 84.5 cm (adjustable by +3.5 cm) | - |
| Height of built-in appliance | 80.5 cm (adjustable by +6.5 cm) | 84.5 cm (adjustable by +6.5 cm) |
| Niche height | min. 80.5 cm (+6.5 cm) | min. 84.5 cm (+6.5 cm) |
| Width | 59.8 cm | 59.8 cm |
| Niche width | 60 cm | 60 cm |
| Depth of freestanding appliance | 60 cm | - |
| Depth of built-in appliance | 57 cm | 57 cm |
| Weight | max. 58 kg | max. 49 kg |
| Voltage | see data plate | |
| Rated load | see data plate | |
| Fuse rating | see data plate | |
| Test certifications awarded | see data plate | |
| Water pressure | 50–1000 kPa | 50–1000 kPa |
| Hot water connection | up to max. 60 °C | up to max. 60 °C |
| Delivery head | max. 1 m | max. 1 m |
| Drainage length | max. 4 m | max. 4 m |
| Mains connection cable | approx. 1.7 m | approx. 1.7 m |
| Capacity | 14/15 place settings* | 14/15 place settings* |

* depending on model

Miele Australia Pty. Ltd.

ACN 005 635 398
ABN 96 005 635 398

**Miele Experience Centre and
Head Office Melbourne:**

1 Gilbert Park Drive
Knoxfield, VIC 3180

Miele Experience Centre South Melbourne:

206-210 Coventry Street
South Melbourne, VIC 3205

Miele Experience Centre and Office Sydney:

3 Skyline Place
Frenchs Forest, NSW 2086

Miele Experience Centre and Office Brisbane:

Tenancy 4C, 63 Skyring Terrace
Newstead, QLD 4006

Miele Experience Centre Gold Coast:

131 Ferry Road
Southport, QLD 4215

Miele Experience Centre and Office Adelaide:

83-85 Sir Donald Bradman Drive
Hilton, SA 5033

Miele Experience Centre and Office Perth:

205-207 Stirling Highway
Claremont, WA 6010

1300 464 353 (1300 4 MIELE)

www.miele.com.au

Miele New Zealand Limited

IRD 98 463 631

**Miele Experience Centre
and Head Office Auckland:**

8 College Hill
Freemans Bay, Auckland 1011

**Miele Experience Centre
Wellington:**

183 Featherston Street
Wellington 6011

0800 464 353 (0800 4 MIELE)

www.miele.co.nz

**Miele Global Headquarters
Germany**

Miele & Cie. KG

Carl-Miele-Straße 29
33332 Gütersloh
Federal Republic of Germany

G 5000

en-AU, NZ

M.-Nr. 11 693 850 / 01