

the Bambino™ Plus

Instruction Book - BES500



Breville®



Contents

2	Breville Recommends Safety First
2	Limited Product Warranty
6	Components
8	Features
8	Assembly
9	Functions
15	Care & Cleaning
18	Troubleshooting



Limited Product Warranty

Breville's warranty for this product covers the repair or replacement if it's found to be defective due to faulty materials, workmanship, or function within the warranty period. All legal warranty rights under applicable national legislation will be respected and will not be impaired by our warranty. For details on length of warranty, to obtain a printed copy or to read full terms and conditions please scan the QR code or

visit www.breville.com

Alternatively, call the Breville Service Centre (see back cover for contact details).



QR149

BREVILLE RECOMMENDS SAFETY FIRST

At Breville we are very safety conscious. We design and manufacture consumer products with the safety of you, our valued customer, foremost in mind. In addition we ask that you exercise a degree of care when using any electrical appliance and adhere to the following precautions.

IMPORTANT SAFEGUARDS

READ ALL
INSTRUCTIONS BEFORE
USE AND SAVE FOR
FUTURE REFERENCE

- Carefully read all instructions before operating and save for future reference.
- Remove any packaging material and promotional labels or stickers before using the appliance for the first time.
- To eliminate a choking hazard for young children, remove and safely discard the protective cover fitted

to the power plug of this appliance.

- Do not place the product near the edge of a bench or table during operation. Ensure the surface is level, clean and free of water and other substances.
- Do not let the cord hang over the edge of a bench or table, or become knotted. Keep away from hot gas or electric burner, or where it could touch a heated oven.
- Do not use the Bambino™ Plus inside a cabinet.
- This appliance can be used by children aged from 8 years and above if they have been given supervision or instruction concerning use of the appliance in a safe way and understand the hazards involved. Cleaning and user maintenance shall not be made by children unless they are aged from 8 years and above and supervised. Keep the appliance and its cord out of reach of children aged less than 8 years.
- Appliances can be used by persons with reduced physical, sensory or mental capabilities or lack of experience and knowledge if they have been given supervision or instruction concerning use of the appliance in a safe way and understand the hazards involved.
- Children shall not play with the appliance.
- Regularly inspect the supply cord, plug and actual appliance for any damage. If found damaged in any way, immediately cease use of the appliance and return the entire appliance to the nearest authorised Breville Service Centre for examination, replacement or repair.
- Keep the appliance and accessories clean. Follow the cleaning instructions provided in this book. Any procedure not listed in this instruction booklet should be performed at an authorised Breville Service Centre.

- The installation of a residual current device (safety switch) is recommended to provide additional safety protection when using electrical appliances. It is advisable that a safety switch with a rated residual operating current not exceeding 30mA be installed in the electrical circuit supplying the appliance. See your electrician for professional advice.

NOTICE TO CUSTOMERS REGARDING MEMORY STORAGE

Please note that in order to better serve our customers, internal memory storage has been imbedded into your appliance.

This memory storage consists of a small chip to collect certain information about your appliance including the frequency of use of the appliance and the manner in which your appliance is being used. In the event your appliance

is returned for service, the information collected from the chip enables us to quickly and efficiently service your appliance. The information collected also serves as a valuable resource in developing future appliances to better serve the needs of our consumers. The chip does not collect any information regarding the individuals who use the product or the household where the product is used. If you have any questions regarding the memory storage chip please contact us at privacy@breville.com

SPECIFIC INSTRUCTIONS FOR BES500

- This appliance is recommended for household use only. Do not use this appliance for other than its intended use. Do not use in moving vehicles or boats. Do not use outdoors. Misuse may cause injury.

- If the appliance is to be left unattended, cleaned, moved, assembled or stored, always switch off the espresso machine by simultaneously pressing the 1 CUP and STEAM buttons. Switch off at the power outlet and unplug.
- Ensure the product is properly assembled before first use.
- Do not use any other liquid apart from cold mains/ tap water. We do not recommend the use of highly filtered, demineralised or distilled water as this may affect the taste of the coffee and how the espresso machine is designed to function.
- Ensure the portafilter is firmly inserted and secured into the group head before starting the extraction. Never remove the portafilter during the brewing process.
- Do not leave the product unattended when in use.
- Do not touch hot surfaces. Allow the product to cool down before moving or cleaning any parts.
- Use caution when operating the machine, as metal surfaces are liable to get hot during use.
- Use caution when descaling as hot steam may be released. Before descaling, ensure drip tray is inserted. Refer to 'Care & Cleaning' for further instructions.



WARNING

Do not immerse power cord, power plug or appliance in water or any other liquid.



WARNING

Misuse may cause injury.

**FOR HOUSEHOLD USE ONLY
SAVE THESE INSTRUCTIONS**



Components

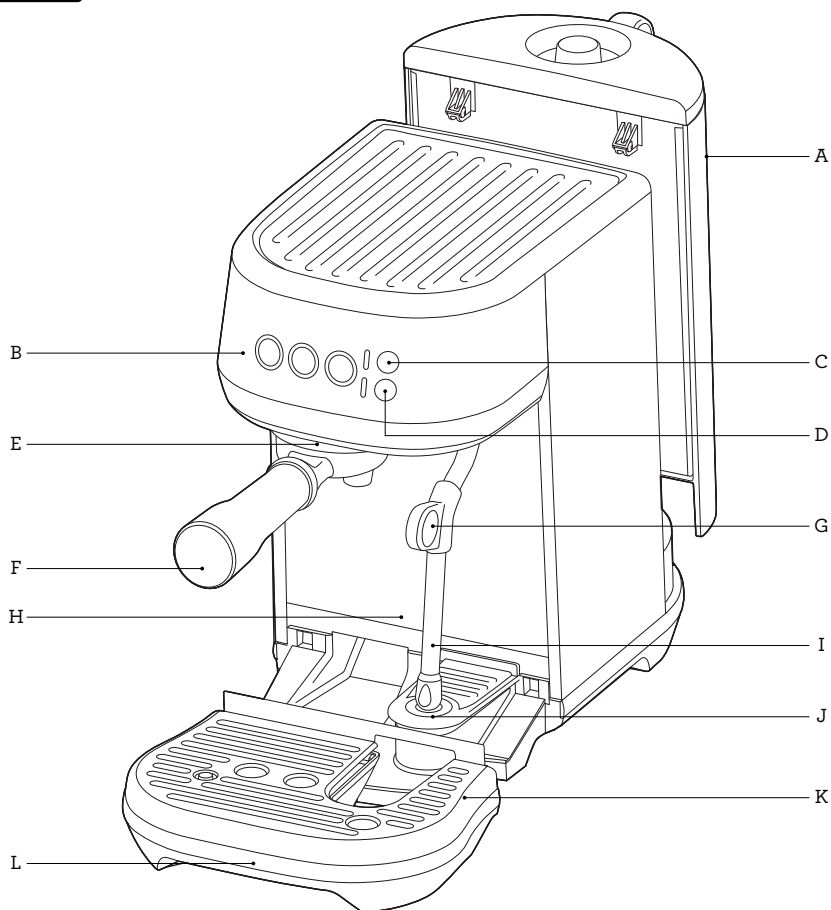

- | | |
|---|--|
| A. 1.9L removable water tank | F. 54mm stainless steel portafilter |
| B. Control panel
1 CUP, 2 CUP and STEAM buttons
With preset shot durations or
programmable durations and volumes | G. Steam wand grip |
| C. MILK TEMP settings
Select from Warm, Ideal and Hot | H. Extra-tall cup clearance for tall mugs |
| D. MILK FOAM settings
Select from Low, Medium and High | I. Steam wand
With automatic milk texturing |
| E. Group head | J. Milk jug temperature sensor |
| | K. Removable drip tray grid |
| | L. Removable drip tray
With full indicator |

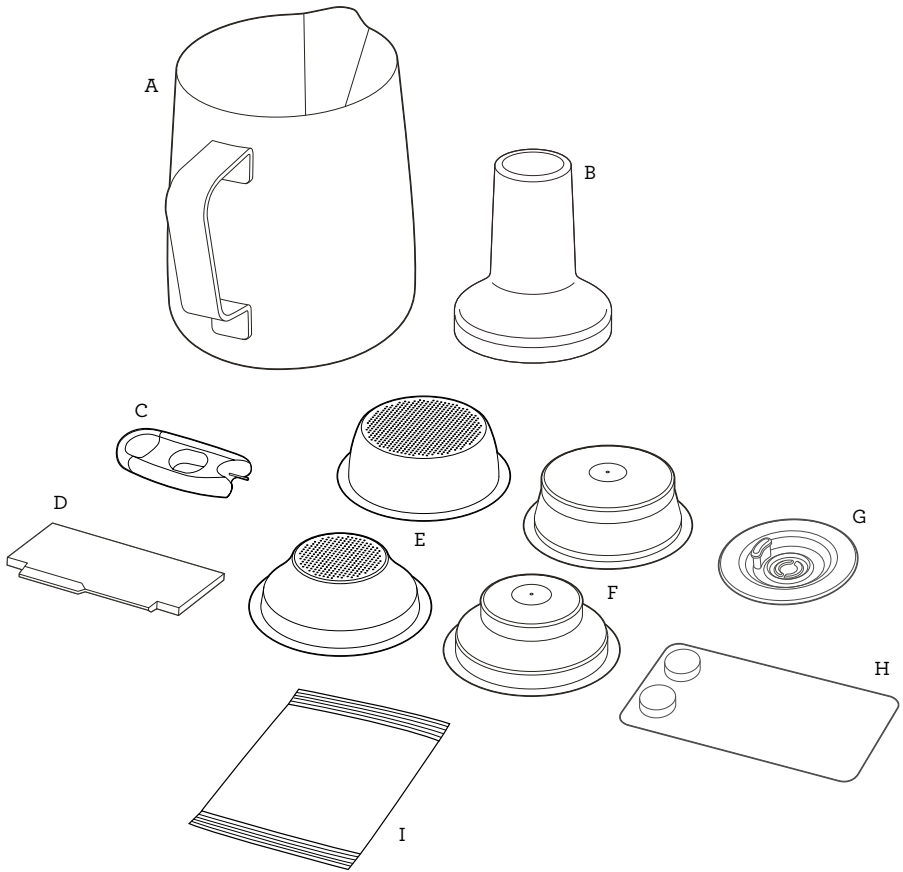

ACCESSORIES

- A. Stainless steel milk jug
With MIN and MAX markings
- B. 54mm tamper
- C. Steam wand tip cleaning tool
(Located under water tank)
- D. The Razor™ precision trimming tool
- E. Single Wall filter baskets (1 cup & 2 cup)
- F. Dual wall filter baskets (1 cup & 2 cup)
- G. Cleaning disc
- H. Espresso cleaning tablets
- I. Descaling powder



Bambino™ Plus Features

COMPACT FOOTPRINT

Cafe quality coffee in a compact machine.

AUTOMATIC HANDS FREE MILK TEXTURING

Automatically textures milk to the selected temperature and style from silky smooth latté to creamy cappuccino. Automatic purge removes residual milk from the steam wand when returned to the downward position.

THERMOJET™ TECHNOLOGY

Innovative heating system achieves ideal extraction temperature in 3 seconds.

PID TEMPERATURE CONTROL

Electronic PID temperature control for increased temperature stability.

LOW PRESSURE PRE-INFUSION

Applies low water pressure at the start of the extraction to gently expand grinds for an even extraction.

VOLUMETRIC CONTROL

Preset 1 & 2 cup volumes, manual over-ride or programmable shot volumes.

THE RAZOR™ DOSE TRIMMING TOOL

Patented twist blade trims down the puck to the right level for precision dosing and a consistent extraction.



Assembly

BEFORE FIRST USE

Machine Preparation

Remove and discard all labels and packaging materials attached to your machine. Ensure you have removed all parts and accessories before discarding the packaging.

Clean the drip tray, drip tray grid, portafilter, filter baskets and milk jugs using warm water and a gentle dish washing liquid. Rinse well and dry thoroughly before use.



Functions

FIRST USE

1. Remove the water tank and fill with potable water to the indicated MAX line. Replace the water tank onto the machine.
2. Ensure that the drip tray is correctly positioned on the machine.
3. Plug the power cord into the power outlet and switch on.
4. Press the 1 CUP, 2 CUP or STEAM buttons to turn the machine on.

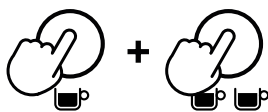

5. Place a 500ml container under the portafilter and steam wand for the water drips for the first cycle.
6. Press the 1 CUP button and the machine will commence its first use cycle.



7. Once complete, the machine will go into ready mode and all lights will be illuminated. The first use cycle is to rinse the machine and prime the heating system.



NOTE

The first use cycle is to rinse the machine and prime the heating system.

TURNING OFF MACHINE

To turn the machine off, press the 1 CUP and STEAM button simultaneously.

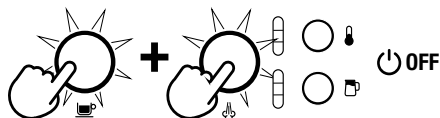

FILLING THE WATER TANK

Lift the water tank from the machine. Remove the water tank lid and add potable water to the water tank, filling to the MAX marking indicated.

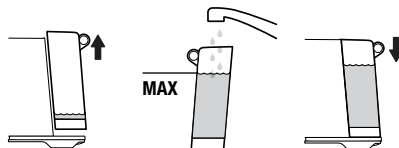

Replace the water tank onto the machine, ensuring it is properly attached and sitting flush against the back of the machine.

If the 1 CUP, 2 CUP and STEAM buttons illuminate, the water tank has been correctly attached.

The machine will detect when the water level is low. The 1 CUP, 2 CUP and STEAM buttons will not be illuminated.

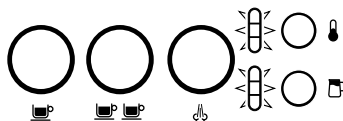

When this occurs, add water to the water tank. Once there is sufficient water, all buttons will be illuminated and the machine can be used.

FILTER BASKETS

This machine includes both single and dual wall 1 Cup and 2 Cup filter baskets. Use the 1 cup filter basket when brewing a single cup and the 2 cup filter baskets when brewing 2 cups or a stronger single cup or mug.

Adjust the grind amount and size when switching from 1 cup to a 2 cup filter basket, or vice versa.

The provided filter baskets are designed for:

1 Cup filter basket = 8-11g

2 Cup filter basket = 16-19g

SINGLE WALL FILTER BASKETS

Single Wall filter baskets should be used when grinding fresh whole coffee beans roasted less than 30 days. These allows you to experiment with grind, dose and tamp to create a more balanced espresso.

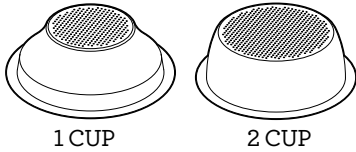

DUAL WALL FILTER BASKETS

Dual Wall filter baskets should be used when using pre-ground coffee and older beans that are past the 30 day roast date. These regulate the pressure and helps to optimise the extraction regardless of the grind, dose and tamp pressure or freshness.

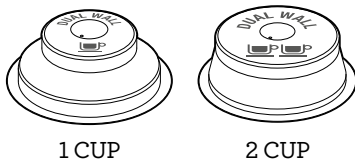

too quickly. The resulting espresso will be UNDER EXTRACTED and lacking in colour and flavour.

COFFEE DOSE AND TAMPING

- Insert the filter basket into the portafilter.
- Grind enough coffee to fill the filter basket.
- Tap the portafilter several times to collapse and distribute the coffee evenly in the filter basket.
- Using the tamper, tamp down firmly (approx. 10–15kgs of pressure). The amount of pressure is not as important as the consistent pressure every time.

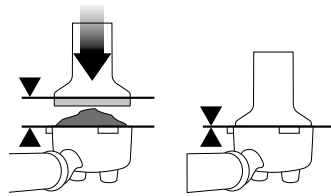

- As a guide, the top edge of the cap on the tamper should be level with the top of the filter basket AFTER the coffee has been tamped.

NOTE

Use Razor™ dose trimming tool to precisely control the dose of ground coffee AFTER you tamp.

THE GRIND

When grinding coffee beans, the grind size should be fine but not too fine. The grind size will affect the rate at which the water flows through the ground coffee in the filter basket and the taste of the espresso.

If the grind is too fine (looks like powder and feels like flour when rubbed between the fingers), the water will not flow through the coffee even when under pressure. The resulting espresso will be OVER EXTRACTED, dark in colour and bitter in flavour.

If the grind is too course, the water will flow through the ground coffee in the filter basket

NOTE

We recommend quality 100% Arabica beans with a 'Roasted On' date stamped on the bag, not a 'Best Before' or 'Use By' date. Coffee beans are best consumed between 5–20 days after the 'Roasted On' date. Stale coffee may pour too quickly from the portafilter spouts and taste bitter and watery.

TRIMMING THE DOSE

The Razor™ precision dose trimming tool allows you to trim the puck to the right level for a consistent extraction.

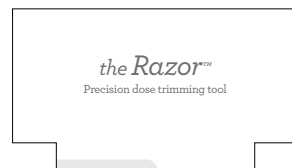

- Insert the Razor™ tool into the coffee basket until the shoulders of the tool rest on the rim of the basket. The blade of the dosing tool should penetrate the surface of the tamped coffee.
- Rotate the Razor™ dosing tool back and forth while holding the portafilter on an angle over the knock box to trim off excess coffee grinds. Your coffee filter is now dosed with the correct amount of coffee.

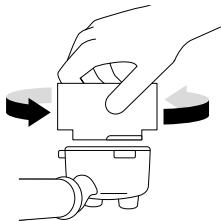

- Wipe excess coffee from the rim of the filter basket to ensure a proper seal is achieved in the group head.

PURGING THE GROUP HEAD

Before placing the portafilter into the group head, run a short flow of water through the group head by pressing the 1 CUP button. This will stabilise the temperature prior to extraction.

INSERTING THE PORTAFILTER

Place the portafilter underneath the group head so that the handle is aligned with the INSERT position. Insert the portafilter into the group head and rotate the handle towards the centre until resistance is felt.

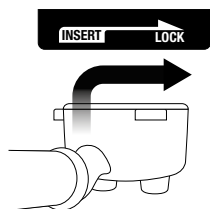

Place your cup/s under the portafilter on the drip tray.

EXTRACTING ESPRESSO

- As a guide the espresso will start to flow after 8-12 seconds (infusion time) and should be the consistency of dripping honey.

- If the espresso starts to flow after less than 7 seconds, you have either under dosed the filter basket and /or the grind is too coarse. This is an UNDER EXTRACTED shot.
- If the espresso starts to drip but doesn't flow after 12 seconds, the grind is too fine. This is an OVER EXTRACTED shot.

PRE-PROGRAMMED SHOT VOLUME

- 1 CUP

Press the 1 CUP button once, the button will flash indicating that it has been selected. A preset single espresso volume of approximately 30mls will be extracted. The machine will automatically stop once the pre-set volume has been extracted.

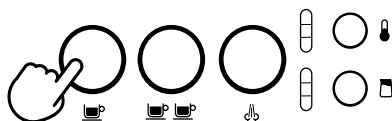

PRE-PROGRAMMED SHOT VOLUME

- 2 CUP

Press the 2 CUP button once, the button will flash indicating that it has been selected. A preset single espresso volume of approximately 60mls will be extracted. The machine will automatically stop once the pre-set volume has been extracted.



NOTE

Pressing the 1 CUP or 2 CUP buttons during a programmed espresso will immediately stop the extraction.

MANUAL PRE-INFUSION AND SHOT VOLUME

Press and hold the 1 CUP or 2 CUP button for the desired pre-infusion time. Release the button to start the extraction. Press the flashing button again to stop the extraction.

PROGRAMMING SHOT VOLUME

Press and hold the 1 CUP and 2 CUP buttons for 2 seconds, the buttons will illuminate and flash.



To set the 1 CUP volume:

- Press the 1 CUP button to start the extraction.
- Press the 1 CUP button again to stop the extraction. The modified volume will be saved.

To set the 2 CUP volume, follow the above steps but select the 2 CUP button to start and stop the extraction.

SETTING THE MILK TEMPERATURE

The machine has 3 milk temperature settings;

- 1 - Warm
- 2 - Ideal
- 3 - Hot



When turning on the espresso machine, the milk temperature setting will default to the last chosen setting. Press the MILK TEMP button until the desired temperature is illuminated.

SETTING THE MILK FOAM

The machine has 3 milk foam settings;

- 1 - Low
- 2 - Medium
- 3 - High



When turning on the machine, the milk foam setting will default to the last chosen setting. Press the MILK FOAM button until the desired foam setting is illuminated.

TEXTURING MILK

Different brands and types of milk and milk alternatives will texture differently. You may need to adjust the foam level according.

NOTE

Prior to texturing milk, it is recommended to momentarily purge the steam wand. To do this press the STEAM button to start purging and press it again to stop.

TO TEXTURE MILK

- Start with fresh cold milk.
- Fill the milk jug to between the min and max position.
- Lift the steam wand and insert into the milk jug.
- Lower the steam wand, ensuring it is fully down.
- The milk jug must rest on the milk temperature sensor located on the drip tray and the milk should cover the steam wand tip.

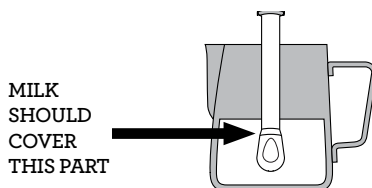
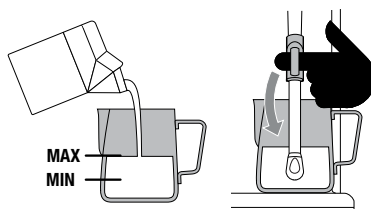

- Press the MILK TEMP and MILK FOAM buttons to select the desired settings.
- Press the STEAM button, the button will flash while texturing.
- The milk texturing will stop automatically when the selected milk temperature is reached.
- Lift the steam wand to remove the milk jug.
- Wipe the wand and tip with a clean damp cloth.
- Lower the steam wand to the down position and the steam wand will automatically purge.

CAUTION: BURN HAZARD

Pressurised steam can still be released, even after the machine has been switched off. Children must always be supervised.



NOTE

When the machine creates steam, a pumping noise can be heard. This is normal operation.



NOTE

Use only the supplied stainless steel milk jug to froth milk using this machine. The use of other containers may lead to dangerous conditions.

MANUAL MILK TEXTURING

Auto milk texturing and auto shut-off are disabled during manual milk texturing.

- Fill the milk jug to between the MIN and MAX markings.
- Lift the steam wand and insert into the milk jug with the steam wand tip 1-2cm below the surface of the milk, close to the right-hand side of the jug at a 3 o'clock position.
- Press the STEAM button to begin texturing



- Keep the steam wand tip just under the surface of the milk until the milk is spinning clockwise, producing a vortex (whirlpool effect).
- With the milk spinning, slowly lower the jug. This will bring the steam wand tip to the surface of the milk and start to introduce air into the milk.
- Gently break the surface of the milk with the tip to get the milk spinning fast enough.
- Keep the steam wand tip at or slightly below the surface, continuing to maintain the vortex. Texture the milk until sufficient volume is obtained.
- Lift the jug to lower the tip beneath the surface but keep the vortex spinning. The milk is at the correct temperature (60-65°C) when the jug is hot to touch.



- When texturing is complete, press the STEAM button.
- Remove the steam wand from the milk jug.
- Wipe the wand and tip with a clean damp cloth.
- Lower the steam wand to the down position and the steam wand will automatically purge.

STEAM WAND PURGING

After texturing milk, the steam wand must be returned to the lowered position and allowed to automatically purge. Not doing so, could result in the steam wand blocking.

If the steam wand remains in the raised position, the machine will display a lower steam wand alert; illuminating the MILK TEMP and MILK FOAM lights in a downwards pattern, identifying that the steam wand needs to be lowered.

To manually commence the steam wand purge, with the steam wand lowered, press and hold the STEAM button for 5 seconds.

STEAM WAND BLOCKED

During milk texturing, if the machine detects that the steam wand is blocked, it will immediately stop operating and the STEAM button light will be off. Both the milk temperature and milk foam lights will fully illuminate and flash. These lights will flash until a steam tip clean cycle has been complete, see 'Cleaning the Steam Wand' for further instructions.

HOT WATER OPERATON

Hot water through the steam wand:

When machine is on 'ready mode', lift the steam wand, press 1 CUP and MILK FOAM buttons, and hot water flow will start through the steam wand. Press the 1 CUP button to stop hot water flow.







WARNING

Cup temperature is at 90°C (194°F). Be careful in handling hot beverages.

EXTRACTION TIPS

A great espresso is about achieving the perfect balance between sweetness, acidity, and bitterness. The flavour of your coffee will depend on many factors, such as the type of coffee beans, degree of roast freshness, coarseness or fineness of the grind, dose of ground coffee and tamping pressure. Experiment by adjusting these factors just one at a time to achieve the taste of your preference.

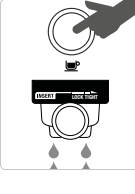
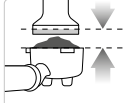
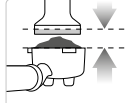
CORRECT EXTRACTION	UNDER EXTRACTION	OVER EXTRACTION
		
<ul style="list-style-type: none"> • Flow starts after 8-12 secs • Flow slow like warm honey • Crema is golden brown with a fine mousse texture • Espresso is dark brown 	<ul style="list-style-type: none"> • Flow starts after 1-6 secs • Flow fast like water • Crema is thin and pale • Espresso is pale brown • Tastes bitter/sharp, weak and watery 	<ul style="list-style-type: none"> • Flow starts after 12 secs • Flow drips or not at all • Crema is dark and spotty • Espresso is very dark brown • Tastes bitter and burnt
<p>AFTER EXTRACTION</p>	<p>SOLUTIONS</p>	<p>SOLUTIONS</p>
<p>REMOVE USED GRINDS</p>  <p>Used grinds will form a coffee 'puck'. If the puck is wet, refer to the 'Under Extraction' section.</p>	<p>EXPERIMENT WITH GRIND:</p> <ul style="list-style-type: none"> • Grind needs to be finer for a slower extraction. • Ensure you are controlling dose with the Razor™. <p style="text-align: center;">Adjust & re-test</p>	<p>EXPERIMENT WITH GRIND:</p> <ul style="list-style-type: none"> • Grind needs to be coarser for a faster extraction. • Ensure you are controlling dose with the Razor™. <p style="text-align: center;">Adjust & re-test</p>
<p>RINSE FILTER BASKET</p>  <p>Keep the filter basket clean to prevent blockages. Without ground coffee in the filter basket, lock the portafilter into the machine and run hot water through.</p>	 <p>ALWAYS TAMP TO LINE</p> <p>Adjust & re-test</p> <p>Tamp using 10-15kgs of pressure. The top edge of metal cap on the tamper should be level with the top of the filter basket AFTER tamping.</p> <p>Trim the puck to the right level using the Razor™ precision dose trimming tool.</p>	 <p>ALWAYS TAMP TO LINE</p> <p>Adjust & re-test</p> <p>Tamp using 10-15kgs of pressure. The top edge of metal cap on the tamper should be level with the top of the filter basket AFTER tamping.</p> <p>Trim the puck to the right level using the Razor™ precision dose trimming tool.</p>

	GRIND	GRIND DOSE	TAMP
OVER EXTRATED BITTER • ASTRINGENT	Too fine	Too much Use razor to trim	Too heavy
BALANCED	Optimum	8-11g (1 cup) 16-19g (2 cup)	10-15kg
UNDER EXTRACTED UNDERDEVELOPED • SOUR	Too coarse	Too little Increase dose & use razor to trim	Too light



Care & Cleaning

+ + CLEANING CYCLE

The machine will detect when 200 extractions have been carried out since the last cleaning cycle; this will be shown by the 1 CUP and 2 CUP buttons alternately flashing. This indicates that the group head needs cleaning. This is a flushing cycle and is separate from descaling.

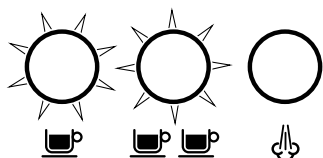

TO PERFORM A CLEANING CYCLE

1. Insert the provided cleaning disc into the filter basket in the portafilter.
2. Place a cleaning tablet on top of the cleaning disc.
3. Lock the portafilter into the group head.
4. Empty the drip tray and replace onto the machine. Place a 2L / 68 fl.oz container under the portafilter and steam wand sitting on the drip tray.

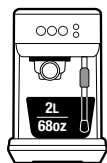

5. Fill the water tank to the MAX line then reattached to the machine, ensuring it is correctly attached.



6. Press and hold the 1 CUP and 2 CUP buttons for 5 seconds to enter the cleaning cycle mode.

7. The 1 CUP and 2 CUP buttons will remain illuminated. Press either 1 CUP or 2 CUP to begin the cleaning cycle. When the cycle is in progress, the lights will alternatively flash.
8. Once the cycle is complete the machine will ready to ready mode.
9. Remove and rinse the portafilter, cleaning disc, drip tray and container.



NOTE

The user can also manually enter the cleaning cycle mode before the cleaning cycle alert is triggered. Press and hold 2 CUP and STEAM buttons simultaneously for five seconds when the unit is at off mode (all lights are off).



DESCALING

After regular use, hard water can cause mineral build up in and on many of the inner functioning components, reducing the brewing flow, brewing temperature, power of the machine, and the taste of the espresso.

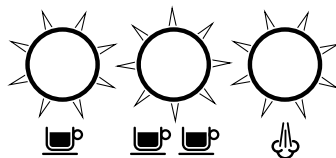

The machine will indicate that it requires descaling when the 1 CUP and STEAM button and the 2 CUP button flash alternately for 15 seconds. Pressing any of these buttons will cancel the alert and return the machine to ready mode.



WARNING

Do not immerse the power cord, power plug or appliance in water or any other liquid. The water tank should never be removed or completely emptied during descaling.



NOTE

Ensure that the water filter is removed from the water tank before adding the descaling powder when descaling the machine.

TO DESCALE

1. Empty the drip tray and re-insert into position on the machine.
2. Fill the water tank to the DESCALE line indicated and add the descaling agent to the water.

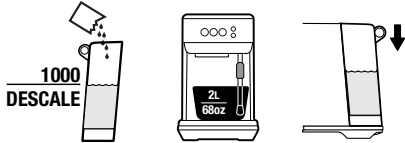

3. Place a 2L / 68 fl.oz container under the portafilter and steam wand.
4. Turn the machine off by simultaneously pressing the 1 CUP and STEAM buttons, and allow it to completely cool before descaling.



5. With the machine off, press the 1 CUP and STEAM buttons simultaneously for 5 seconds to enter descale mode.

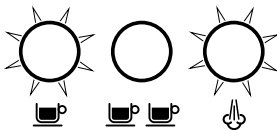

6. The 1 CUP and STEAM buttons will illuminate, indicating that the machine is ready to start descaling.



7. Press the 1 CUP or STEAM button to begin the descale cycle. These buttons will alternately flash throughout the cycle.

8. Once the descale solution has been used up, the descale mode will pause. Refill the water tank to the MAX line and empty the waste water container, then replace both parts on to the machine.
9. The 1 CUP and STEAM buttons will illuminate when the machine is ready. Press the 1 CUP or STEAM button to resume descaling.
10. When descaling is complete, the 1 CUP and STEAM button will alternately flash. The machine will then go into standby mode.

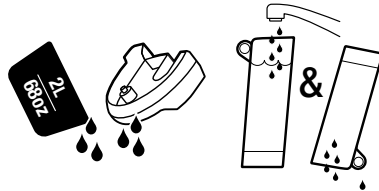

11. Remove and empty the waste water container. Rinse the drip tray and water tank and dry thoroughly before replacing them back onto the machine.

STEAM WAND BLOCKED

During milk texturing, if the machine detects that the steam wand is blocked, it will immediately stop operating and the STEAM button light will be off. Both the milk temperature and milk foam lights will fully illuminate and flash. These lights will flash until a manual steam purge has been completed.

CLEANING THE STEAM WAND

- The steam wand should always be cleaned after texturing milk. Wipe the steam wand with a damp cloth.
- If any of the holes in the tip of the steam wand become blocked, it may reduce frothing performance. Manually purge the steam wand to try and clear the holes.
- If the steam wand remains blocked, unscrew the steam wand tip, using the steam tip cleaning tool then use the tool to unblock the holes; cleaning tool is located in the back of the machine, under the water tank.

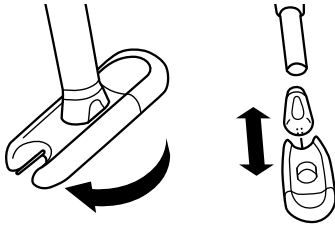

- Rinse the steam tip and wipe with a clean, dry cloth. Reassemble the steam wand by screwing the steam tip back on to the steam wand. Purge the steam wand after cleaning.

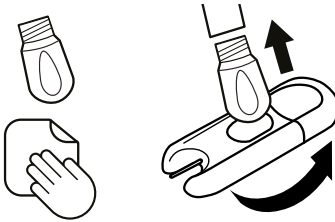

CLEANING THE FILTER BASKETS AND PORTAFILTER

- The filter baskets and portafilter should be rinsed under hot water directly after use to remove all residual coffee oils.
- If the holes in the filter baskets become blocked, use the steam wand cleaning tool to unblock the holes.

CLEANING THE SHOWER SCREEN

- The group head interior and shower screen should be wiped with a damp cloth to remove any ground coffee particles.
- Periodically run hot water through the machine with the filter basket and portafilter in place, without any ground coffee, to rinse out any residual coffee.

CLEANING THE DRIP TRAY

- The drip tray should be removed, emptied and cleaned after each use or when the drip tray indicator rises through the drip tray grid.
- Remove the drip tray grid and wash both parts in warm soapy water.

CLEANING THE OUTER HOUSING

- Wipe the outer housing with a soft, damp cloth and then polish with a soft, dry cloth.

NOTE

Do not use any abrasive cleaners, pads or cloths which can scratch the surfaces of the machine.

NOTE

Do not clean any of the parts or accessories in the dishwasher.

WARNING

Do not immerse the power cord, power plug or machine in water or any other liquid.

STORING YOUR MACHINE

Before storing, turn the machine off, switch off and remove the power plug from the power outlet. Empty the water tank and drip tray and ensure the machine is cool, clean and dry. Store in an upright position.

Do not place anything on top of machine.

RESET FACTORY ESPRESSO VOLUME SETTINGS

1. Turn the machine off, by pressing the 1 CUP and STEAM buttons simultaneously for 5 seconds.
2. Press and hold the 1 CUP and 2 CUP buttons for 5 seconds. Buttons will illuminate.
3. Press the 1 CUP or 2 CUP buttons and the light will flash 3 times to indicate that all volumes have been reset.
4. Machine will then return to ready mode.

NOTE

Press any other button to exit factory reset mode.



Troubleshooting

PROBLEM	POSSIBLE CAUSES	EASY SOLUTION
Water does not flow from the group head. No hot water.	Water tank is empty.	Fill tank.
	Water tank is not fully inserted and locked into position.	Push water tank down completely to lock into place.
	Machine needs to be descaled.	Perform descale cycle.
	Coffee is ground too finely and/or too much coffee in filter basket and/or over tamping and/or filter basket is blocked.	See below, 'Espresso only drips from the portafilter spouts or not at all'.
Espresso only drips from the portafilter spouts or not at all.	Coffee is ground too finely.	Use slightly coarser grind. Refer to 'Coffee Dose and Tamping' on page 10 and 'Extraction Tips' on page 14.
	Too much coffee in the filter basket.	Lower dose of coffee. After tamping, trim the coffee dose using the Razor™ dose trimming tool. Refer to 'Coffee Dose and Tamping' on page 10 and 'Extraction Tips' on page 14.
	Coffee tamped too firmly.	Tamp between 10-15kg of pressure.
	Water tank is empty.	Fill tank.
	Water tank is not fully inserted and locked into position.	Push water tank down completely to lock into place.
	The filter basket may be blocked.	Use the pin on the end of the provided cleaning tool to unblock the hole(s).
	Machine needs to be descaled.	Perform descale cycle.
Water doesn't come through (the machine makes loud noise).	Water tank is empty or water level is below MIN.	Fill tank.
	Froth and temperature lights flashes together.	Steam function error.
Water tank may be empty.		Press and hold steam button for 3 seconds to purge the system.

PROBLEM	POSSIBLE CAUSES	EASY SOLUTION
Espresso runs out too quickly.	Coffee is ground too coarsely.	Use slightly finer grind. Refer to 'Coffee Dose and Tamping' on page 10 and 'Extraction Tips' on page 14.
	Not enough coffee in the filter basket.	Increase dose of coffee. Tamp then use the Razor™ dose trimming tool to trim off excess coffee. Refer to 'Coffee Dose and Tamping' on page 10 and 'Extraction Tips' on page 14.
	Coffee tamped too lightly.	Tamp between 10-15kg of pressure.
Espresso runs out around the edge of the portafilter.	Portafilter not inserted in the group head correctly.	Ensure portafilter is completely inserted and rotated until resistance is felt.
	There are coffee grounds around the filter basket rim.	Clean excess coffee from the rim of the filter basket to ensure a proper seal in group head.
	Too much coffee in the filter basket.	Lower dose of coffee. Refer to 'Coffee Dose and Tamping', page 10. After tamping, trim the coffee dose using the Razor™ dose trimming tool.
No steam.	Machine has not reached operating temperature.	Allow time for the machine to reach operating temperature.
	Water tank is empty.	Fill tank.
	Water tank is not fully inserted and locked into position.	Push water tank down completely to lock into place.
	Machine needs to be decalcified.	Perform descale cycle.
	Steam wand is blocked.	Refer to 'Cleaning the Steam Wand', page 16.
Pulsing/pumping sound while extracting espresso or steaming milk.	The machine is carrying out the normal operation of the pump.	No action required as this is the normal operation of the machine.
	Water tank is empty.	Fill tank.
	Water tank is not fully inserted and locked into position.	Push water tank down completely to lock into place.
Coffee not hot enough.	Portafilter not pre-heated.	Rinse portafilter under hot water outlet. Dry thoroughly.
Milk too hot.	Jug incorrectly positioned.	Ensure milk jug is correctly positioned on sensor. Adjust milk temperature setting.

PROBLEM	POSSIBLE CAUSES	EASY SOLUTION
No crema.	Coffee tamped too lightly.	Tamp between 8 or 10–15kg of pressure.
	Coffee is ground too coarsely.	Use slightly finer grind. Refer to 'Coffee Dose and Tamping' on page 10 and 'Extraction Tips' on page 14.
	Coffee beans or pre-ground coffee are not fresh.	If grinding fresh whole coffee beans, use freshly roasted coffee beans with a 'Roasted On' date and consume between 5–20 days after that date. If using pre-ground coffee, use within a week of grinding.
	The filter basket may be blocked.	Use the pin on the end of the provided cleaning tool to unblock the hole(s).
Water leaking.	Auto purge feature. Immediately after the steam function, the machine will purge water into the drip tray. This ensures the thermocoil is at the optimal temperature.	Ensure the drip tray is firmly pushed in place and emptied whenever the indicator is displayed.
	Water tank is not fully inserted and locked into position.	Push water tank down completely to lock into place.
Machine is on but ceases to operate.	The safety thermal-cut out may have activated due to the pump overheating.	Press the 1 CUP and STEAM button simultaneously for 5 seconds to switch the machine off and unplug from the power outlet. Allow to cool for about 30–60 minutes. If problem persists, call Breville Support.
Too much/too little espresso is being delivered to the cup.	Grind amount and/or grind size settings and/or shot volumes require adjustment.	Adjust the grind amount and/or grind size settings. Refer to 'Coffee Dose and Tamping', page 10, 'The Grind', page 10 and 'Extraction Tips', page 14.



Notes



Notes



Notes

Breville Service Centre

Australian Customers

Phone: 1300 139 798

Web: www.breville.com

New Zealand Customers

Phone: 0800 273 845

Web: www.breville.com

Breville®

Master Every Moment™

Breville, the Breville Logo are trademarks of Breville Pty Ltd ("Breville") and Breville's products are distributed in Australia and New Zealand under license.

Copyright Breville Pty. Ltd. 2023.

Due to continued product improvement, the products illustrated/photographed in this brochure may vary slightly from the actual product.

BES500 ANZ K23