

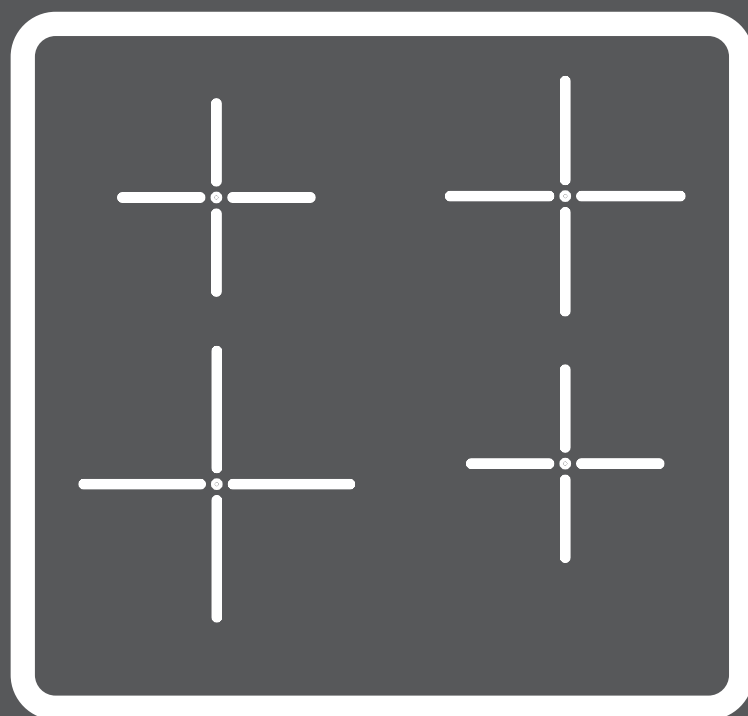

# INDUCTION COOKTOPS

User Manual



## MODELS

CHI644BB, CHI944BB

## CONGRATULATIONS

Congratulations and thank you for choosing our Induction Cooktop. We are sure you will find your new appliance a pleasure to use and a great asset to your cooking. Before you use the appliance, we recommend that you read through the whole user manual which provides a description of the product and its functions.

To avoid the risks that are always present when you use a cooking appliance, it is important that the appliance is installed correctly and that you read the safety instructions carefully to avoid misuse and hazards. For future reference, please store this booklet in a safe place.

## CONDITIONS OF USE

This appliance is intended to be used in household and similar applications such as:

- Staff kitchen areas in shops, offices and other working environments
- Farm houses
- By clients in hotels, motels and other residential type environments
- Bed and breakfast type environments

Record model and serial number here:

Model:.....

Serial number: .....

The symbols you will see in this booklet have these meanings:



warning

Indicates information concerning your personal safety



caution

Indicates information on how to avoid damaging the appliance



tips & information

Indicates tips and information about use of the appliance



environmental tips

Indicates tips and information about economical and ecological use of the appliance



tips & information

Important – check for any damage or marks

If you find the appliance is damaged or marked, you must report it within 7 days if you wish to claim for damage/ marks under the manufacturer's warranty. This does not affect your statutory rights.



environmental tips

Information on disposal for users

- Most of the packing materials are recyclable. Please dispose of those materials by contacting your local authorities and ask for the correct method of disposal.

## CONTENTS

General safety .....	3
Installation instructions .....	4
Assembly .....	5
Product description .....	7
Operating instructions .....	9
Helpful hints and tips.....	12
Care and cleaning .....	14
Environment concerns .....	16
Warranty .....	19

Subject to change without notice.

# general safety

## Safety information

For your safety and correct operation of the appliance, read this manual carefully before the installation and use. Always keep these instructions with the appliance if you move or sell it. The users must fully know the operation and safety functions of the appliance.

## Children and vulnerable people safety



warning

Do not let persons, children included, with reduced physical sensory, reduced mental functions or lack of experience and knowledge to use the appliance. They must have supervision or instruction for the operation of the appliance by a person who is responsible for their safety.

- Keep all packaging away from children. There is the risk of suffocation or injury.
- Keep the children away from the appliance during and after the operation, until the appliance is cold.

## Safety during operation

- Remove all packaging, stickers and layers from the appliance before the first use.
- Set the cooking zones to "off" after each use.
- The risk of burns! Do not put objects made of metal, for example cutlery or saucepan lids, on the surface that you cook. They can become hot.
- The users with an implanted pacemaker must keep their upper body minimum 30cm from induction cooking zones that are activated.



warning

Fire risk! Fats and oils can become hot very quickly with ignition.

## Correct operation

- The appliance is only for domestic use.
- Do not use the appliance as a work or a storage surface.
- Do not put or keep flammable liquids and materials, easy fusible objects (made of plastic or aluminium) on or near the appliance.
- Be careful when you connect the appliance to the near sockets. Other than the connection point in the terminal block, do not let the electrical supply cord touch the appliance or hot cookware. Ensure electrical supply cord is not tangled.

## How to prevent damage to the appliance.

- If objects or cookware fall on the glass, the surface can be damaged.
- Cookware made of cast iron, cast aluminium or with damaged bottoms can scratch of the glass. Do not move them on the surface.
- Do not let cookware boil dry to prevent the damage to cookware and glass .
- Do not use the cooking zones with empty cookware or without cookware.
- Do not put aluminium foil on the appliance.

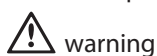

warning

If there is a crack on the surface, disconnect power supply to prevent the electrical shock.

# installation instructions



## tips & information

Before the installation, note down the serial number from the rating plate. The rating plate of the appliance is on its lower casing.

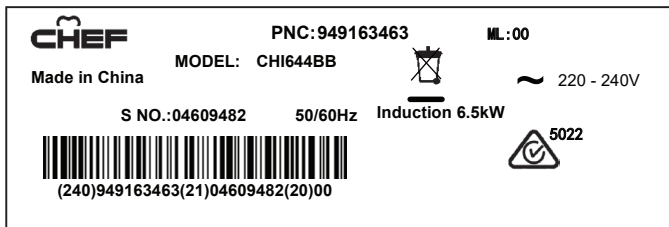

## The Safety Instructions



## WARNING

You must read these!

- Make sure that the appliance has not been damaged in transportation. Do not connect a damaged appliance. If it is necessary, speak to the supplier.
- Only an authorized servicing technician can install, connect or repair this appliance. Use only original spare parts.
- Only use the built-in appliances after you assemble the appliance into correct built-in units and work surfaces that align to the standards.
- Do not change the specification of this appliance. Due to a risk of injury and damage.
- Fully obey the laws, ordinances, directives and standards in the country where you use the appliance (safety regulations, recycling regulations, electrical safety rules etc).
- Keep the minimum distances to other appliances and units.
- Make sure that the ventilation space of 5mm, under the benchtop and directly in front of the appliance is free. The warranty does not cover damages caused by lack of adequate ventilation.
- Install shock protection, for example install the drawers only with a protective floor directly below the appliance.

- Do not use an external timer or a separate remote-control system to operate the appliance.
- Set the cooking zone to “off” after each use. Do not rely on the pan detector.
- Keep the cut surfaces of the worktop safe from moisture with a correct sealant.
- Seal the appliance to the worktop with no space between with a correct sealant.
- Keep the bottom of the appliance safe from steam and moisture, e.g. from a dishwasher or oven.
- Do not install the appliance adjacent to doors and below windows, due to risk of cookware being pushed off hot appliance.



## WARNING

Risk of injury from electrical current. Carefully obey the instructions for electrical connections.

- Make electrical mains terminal free of voltage.
- Install correctly to give shock protection.
- Loose and incorrect plug and socket connections can make the terminal become too hot.
- A qualified electrician must install the connections in the clamps correctly.
- Use a strain relief clamp on cable.
- Use the correct mains cable of type H05BB-F Tmax 90°C (or higher) for a single phase or two phase connection.
- Replace the damaged mains cable with a special cable (type H05BB-F Tmax 90°C; or higher). Speak to our Customer Care team.

The appliance must have the electrical installation which lets you disconnect the appliance from the mains at all poles with a contact opening width of minimum 3mm. You must have correct devices to isolate: line protecting cut-outs, fuses (screw type fuses removed from the holder), earth leakage trips and contactors.

# assembly

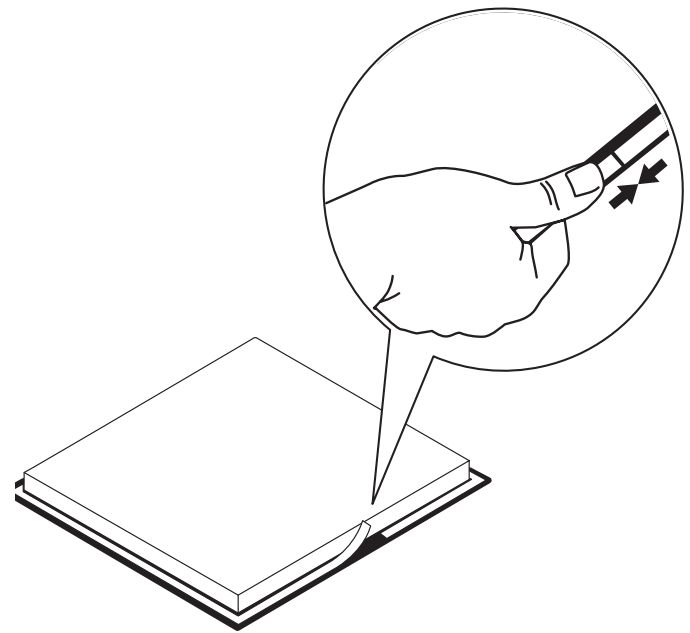
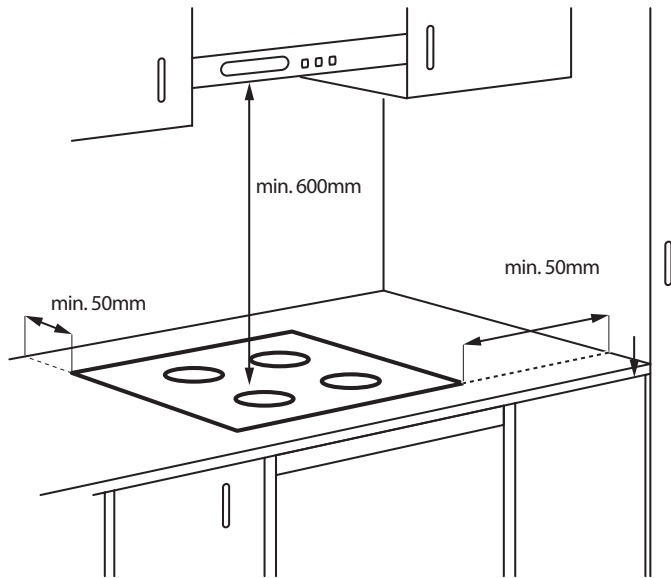

NOTE : The clearance must meet or exceed the minimum recommended for both the rangehood and cooktop. Refer to the rangehood installation manual.

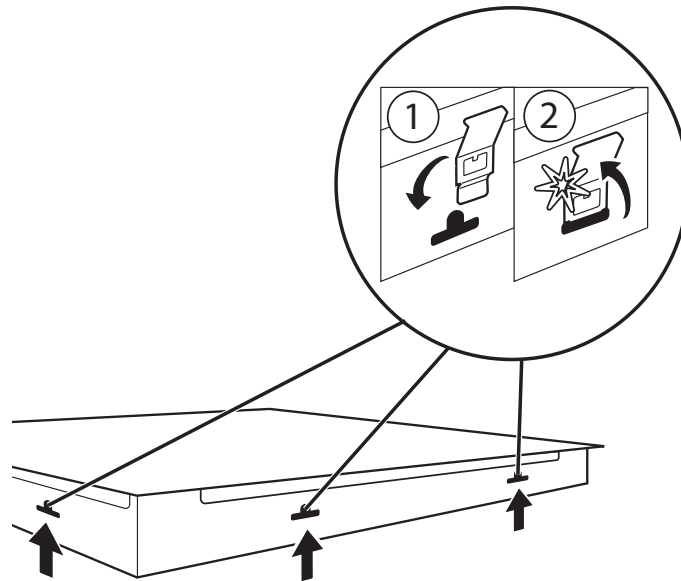

# assembly

CHI644BB

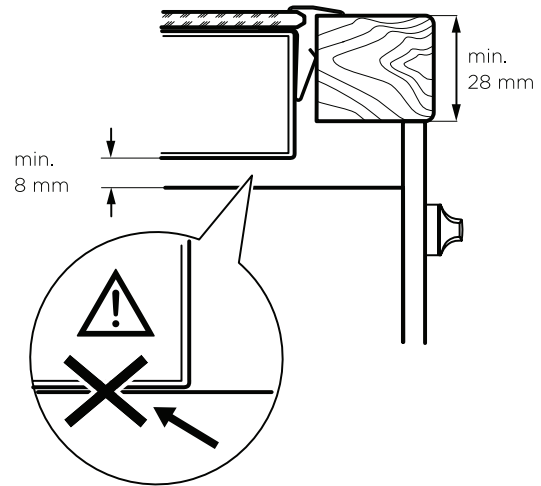
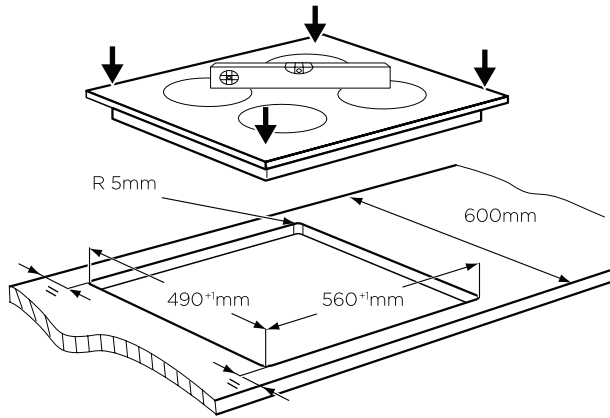

CHI944BB

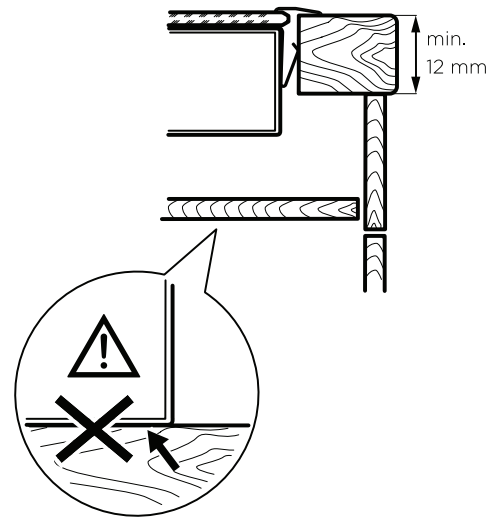
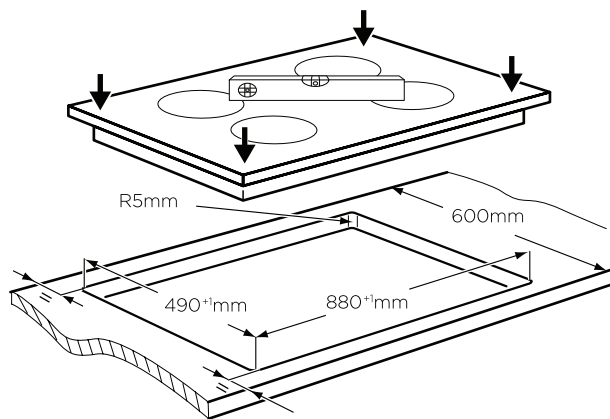

**i IMPORTANT**

It is recommended to centre the bench cutout with equal distance front and back as shown but the product has also been certified to be installed with no clearance between the rear edge of the cooktop glass and rear wall if required. In doing so, installers still need to leave sufficient clearance to take into account that the glass dimensions are larger than the cut out.

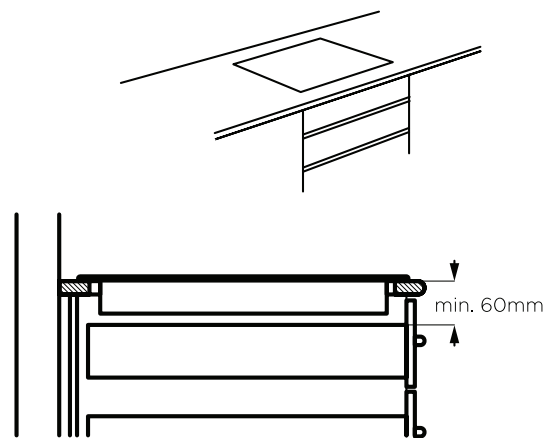
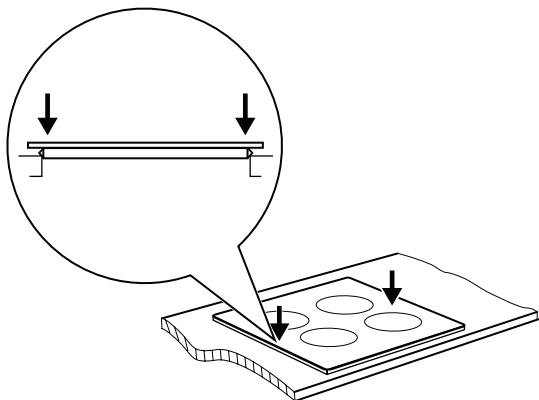

# product description

## General overview

CHI644BB

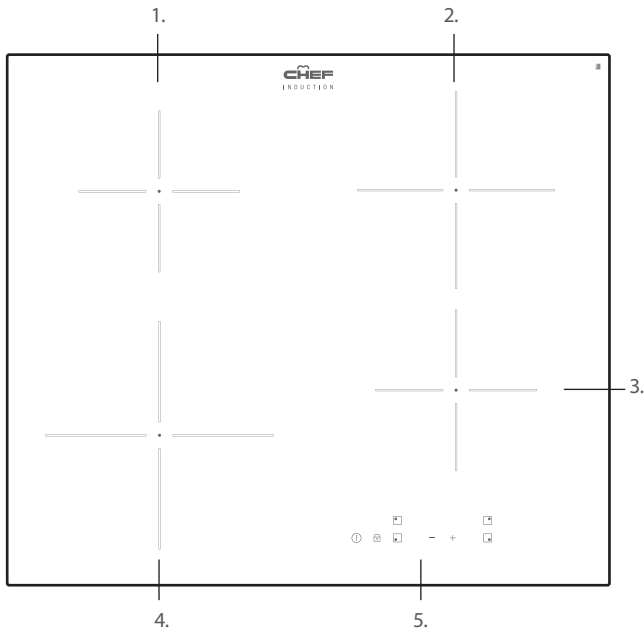

1. Inducton cooking zone 1400W, with Power function 2500W (minimum cookware diameter=125mm)
2. Inducton cooking zone 1800W, with Power function 2800W (minimum cookware diameter=145mm)
3. Inducton cooking zone 1400W, with Power function 2500W (minimum cookware diameter=125mm)
4. Inducton cooking zone 2300W, with Power function 3200W (minimum cookware diameter=180mm)
5. User interface

## Control panel layout

CHI644BB

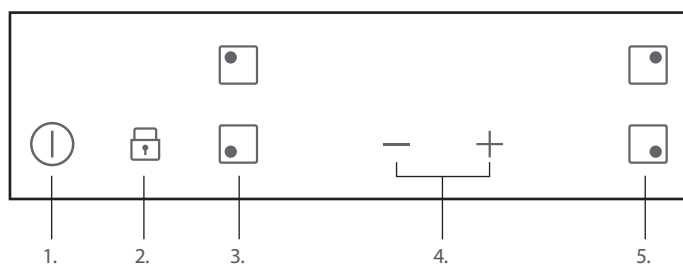

## Operating the sensor field

CHI644BB

	Sensor field	Function
1.		Activates and deactivates the appliance
2.		Locks/unlocks the control panel
3.		Activates the cooking zone
4.		Increases and decreases the heat settings
5.	Heat setting display	Shows the heat setting

## Heat setting displays

CHI644BB

Display	Description
	The cooking zone is deactivated
	The cooking zone is in operation
	The cookware is incorrect or too small, or there is no cookware on the cooking zone
	The lock/the child safety device is in operation
	The power function is in operation
	There is a malfunction
	A cooking zone is still hot (residual heat)
	The automatic switch off is in operation

## Residual heat indicator

warning

The risk of burns from residual heat!

The induction cooking zones make the heat necessary for cooking directly to the bottom of the cookware. The ceramic glass conducts the heat into the cookware.

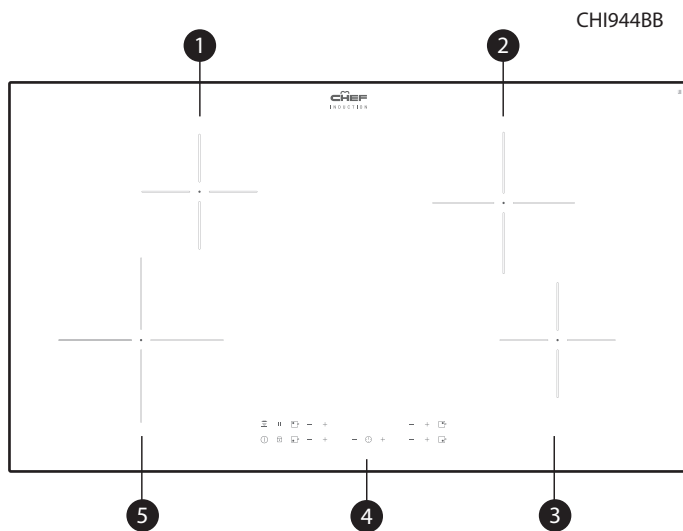

Control panel layout

CHI944BB

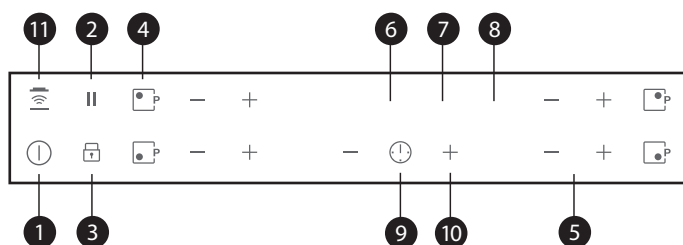

### Operating the sensor fields

	SENSOR FIELD	FUNCTION
1		It activates and deactivates the appliance
2		Sets all operating zones to a keep warm setting
3		It locks/unlocks the control panel
4		It activates the Power function
5		It increases or decreases the heat setting
6	A heat setting display	It shows the heat setting
7	Cooking zones' indicators of timer	It shows for which zone you set the time
8	The timer display	It shows the time in minutes
9		It selects the cooking zone
10		It increases or decreases the time
11		To activate and deactivate the manual mode of the Hob2Hood function  NOTE: H2H functionality requires pairing with a compatible rangehood within the Electrolux group of brands.

- 1 Induction cooking zone 1400 W, with Power function 2500 W (minimum cookware diameter =125 mm).
- 2 Induction cooking zone 1800 W, with Power function 2800 W (minimum cookware diameter =145 mm).
- 3 Induction cooking zone 1400 W, with Power function 2500 W (minimum cookware diameter =125 mm).
- 4 Control panel
- 5 Induction cooking zone 2300 W, with Power function 3200 W (minimum cookware diameter =180 mm).

### Heat setting displays

DISPLAY	DESCRIPTION
	The cooking zone is deactivated.
	The Keep Warm function operates
	The cooking zone operates.
	The Automatic Heat-up function operates.
	The cookware is incorrect or too small, or there is no cookware on the cooking zone.
	There is a malfunction.
	OptiHeat Control (3 step residual heat indicator): continue cooking / keep warm / residual heat
	The Lock/Child Safety device operates.
	The Power function operates.
	The Automatic Switch-Off operates.

### OptiHeat Control ( 3 step residual heat indicator)



WARNING

Risk of burns from residual heat!

OptiHeat Control shows the level of the residual heat. The induction cooking zones make the heat necessary for cooking directly in the bottom of the cookware. The glass ceramic is hot from the heat of the cookware.



# operating instructions



## Activation and deactivation

Touch  for 1 second to activate or deactivate the appliance.





## Automatic switch off

The function deactivates the appliance automatically if:



- All cooking zones are deactivated .
- You do not set the heat setting after you activate the appliance.

- You spill something or put something on the control panel for more than 10 seconds, (a pan, a cloth etc.) Remove the object or clean the control panel.
- The appliance becomes too hot (e.g. when, a saucepan boils dry). Before you use the appliance again, the cooking zone must be cool.
- If you use incorrect cookware. The symbol  comes on and the cooking zone deactivates automatically after 2 minutes.
- If you do not deactivate a cooking zone or change a heat setting. After some time,  comes on and the appliance deactivates. Refer to table.

## The times of Automatic Switch Off

The heat setting				
The cooking zone deactivates after	6 hours	5 hours	4 hours	1.5 hours

## The cooking zone selection

To set the cooking zone touch the sensor field  related with the cooking zone. The display shows the selection by the dot adjacent to the heat setting indication ().

## The heat setting

Set the cooking zone. Press **+** to increase the heat setting. Press **-** to decrease the heat setting. The display shows the heat setting. Touch **+** and **-** at the same time to deactivate the cooking zone.

## Power function

The power function increases power to the induction cooking zones. You can activate the Power function for a maximum of 10 minutes. After that the induction cooking zone automatically sets back to highest setting.

To activate the function:



1. Set the cooking zone.
2. Set the zone for the maximum heat setting.
3. Press **+** and  comes on. To deactivate the function press **-**.

## Power management

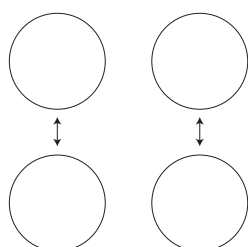
The power management divides the power between two cooking zones in a pair (Refer to the illustration). The power function increases the power to the maximum level for one cooking zone in the pair. Automatically decreases the power in the second cooking zone to a power level. The display for the reduced zone change between two levels.



## Lock





When the cooking zones operate you can lock the control panel, but not . It prevents an accidental change of the heat setting. First set the heat setting. To start this function touch . The  symbol comes on for 4 seconds.

To stop this function touch . The heat setting that you set before comes on. When you switch off the cooktop, you also stop this function.





## The child safety device

This function prevents an accidental operation of the appliance.





To activate the child safety device:

- Activate the appliance with . Do not set the heat settings.
- Touch  for 4 seconds. The symbol  comes on.
- Deactivate the appliance with .

To deactivate the child safety device:

- Activate the appliance with . Do not set the heat settings. Touch  for 4 seconds. The symbol  comes on.
- Deactivate the appliance with .

To override the child safety device for only one cooking time:

- Activate the appliance with . The symbol  comes on.
- Touch  for 4 seconds. Set the heat setting for 10 seconds. You can operate the appliance.
- When you deactivate the appliance with , the child safety device operates again.

### Automatic heat up (CHI944BB only)

You can get a necessary heat setting in a shorter time if you activate the Automatic Heat Up function. This function sets the highest heat setting for some time (see the illustration), and then decreases to the necessary heat setting.

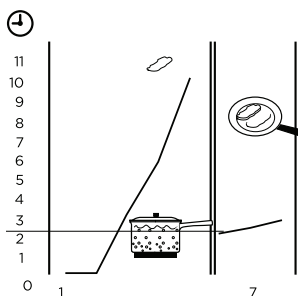

To start the Automatic Heat Up function for a cooking zone: (CHI944BB only)

1. Touch The symbol comes on in the display.
2. Immediately touch adjacent to the element you want to control. The symbol comes on in the display.
3. Immediately touch adjacent to the element you want to control again and again until the necessary heat setting comes on. After 3 seconds comes on in the display.
4. To stop the function touch adjacent to the element you want to control.

### Pause (CHI944BB only)

The function sets all cooking zones that operate to the lowest heat setting .

When operates, you cannot change the heat setting.

The function does not stop the timer function.

- To activate this function touch The symbol comes on symbol come on.
- To deactivate this function touch The heat setting that you set before comes on

### Timer (CHI944BB only)

Use the Count Down Timer to set how long the cooking zone operates for only this one time. Set the Timer after the selection of the cooking zone.

You can set the heat setting before or after you set the timer.

- To set the cooking zone: touch again and again until the indicator of a necessary cooking zone comes on.
- To activate or change the Timer: touch or of the timer to set the time (00 - 99 minutes). When the indicator of the cooking zone starts to flash slow, the time counts down.
- To deactivate the Timer: set the cooking zone with and touch to deactivate the Timer. The remaining time counts back to 00. The indicator of the cooking zone goes out.

- To see the remaining time: set the cooking zone with The indicator of the cooking zone starts to flash quickly. The display shows the remaining time. When the time comes to an end, the sound operates and 00 flashes. The cooking zone deactivates.
- To stop the sound: touch You can use the Timer as a minute minder while the cooking zones do not operate. Touch . Touch or to set the time. When the time comes to an end, the sound operates and 00 flashes
- To stop the sound: touch .

### Hob<sup>2</sup>Hood (CHI944BB only)

This is an advanced automatic function which connects the hob to a special hood. Both the hob and the hood have an infra-red signal communicator. Speed of the fan is defined automatically on basis of mode setting and temperature of the hottest cookware on the hob. You can also operate the fan from the hob manually.

NOTE: H2H functionality requires pairing with a compatible rangehood within the Electrolux group of brands.

### IMPORTANT

For most of the hoods the remote system is originally deactivated. Activate it before you use the function. For more information refer to hood user manual.

### Operating the function automatically (CHI944BB only)





The default automatic mode from the factory is H5. You can change the automatic mode by following the instructions below. When you activate the hob the hood will adjust the fan speed automatically. Please note the below table is a guide, the fan speed varies depending on the temperature measured on the cooking zones of the cooktop which can be affected by the heat setting(s) selected as well as the size and volume of what you are cooking.

#### Automatic modes (CHI944BB only)

	Automatic light	Boiling	Frying
Mode H0	Off	Off	Off
Mode H1	On	Off	Off
Mode H2	On	Fan speed 1	Fan speed 1
Mode H3	On	Off	Fan speed 1
Mode H4	On	Fan speed 1	Fan speed 1
Mode H5	On	Fan speed 1	Fan speed 2
Mode H6	On	Fan speed 2	Fan speed 3

1. The hob detects the boiling process and activates fan speed in accordance with automatic mode.
2. The hob detects the frying process and activates fan speed in accordance with automatic mode.
3. This mode activates the fan and the light and does not rely on the temperature.

#### Changing the automatic mode

1. Deactivate the appliance.
2. Touch  for 3 seconds. The display comes on and goes off
3. Touch  for 3 seconds.
4. Touch  a few times until  comes on.

5. Touch  of the Timer to select an automatic mode





 **IMPORTANT**

To operate the hood directly on the hood panel deactivate the automatic mode of the function.

 **IMPORTANT**

When you finish cooking and deactivate the hob, the hood fan may still operate for a certain period of time. After that time the system deactivates the fan automatically and prevents you from accidental activation of the fan for the next 30 seconds.

#### Operating the fan speed manually (CHI944BB only)

You can also operate the function manually. To do that touch  when the hob is active. This deactivates automatic operation of the function and allows you to change the fan speed manually. When you press  you raise the fan speed by one. When you reach an intensive level and press  again you will set fan speed to 0 which deactivates the hood fan. To start the fan again with fan speed 1 touch .

 **IMPORTANT**

To activate automatic operation of the function, deactivate the hob and activate it again.

#### Activating the light (CHI944BB only)

You can set the hob to activate the light automatically whenever you activate the hob. To do so set the automatic mode to H1 – H6.

 **IMPORTANT**

The light on the hood deactivates 2 minutes after deactivating the hob.

# helpful hints and tips

## tips & information

Use the correct cookware induction cooktop.

Cookware for induction cooking zones

Important! For induction cooking zones a strong electro-magnetic field creates the heat in the cookware very quickly.

Cookware material

- Correct: cast iron, steel, enamelled steel, stainless steel, the bottom made of multilayer (with correct mark from a manufacturer).
- Incorrect: aluminium, copper, brass, glass, ceramic, porcelain.

Cookware is correct for an induction hob if:

FIND THE RIGHT COOKWARE

Only magnetic pots and pans work with induction.

Check to see if your cookware is compatible: Place a magnet on the bottom of your pot or pan - if it clings firmly, the cookware will work with your cooktop.

Choose the right size pot or pan for the right cooking zone.

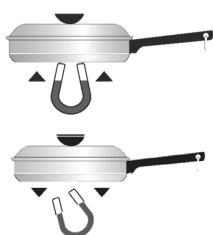

### MAGNET STICKS

Cookware base material has good magnetic characteristics

### MAGNET FALLS

Cookware base material is non-magnetic

- Water boils very quickly on a zone set to the highest heat setting.
- A magnet pulls to the bottom of the cookware.

The bottom of the cookware must be as thick and flat as possible. Cookware dimensions: induction cooking zones adapt to the dimension of the bottom of the cookware automatically to some limit.

The noises during operation

If you can hear:

- A cracking noise: cookware is made of different materials.
- Whistle sound: one or more cooking zones with high power levels and the cookware is made of different materials.
- Humming: high power levels in use.
- Clicking: electric switching occurs.
- Hissing, buzzing: the fan is in operation.

The noises are normal and do not refer to appliance malfunction. If unfamiliar with induction units please first compare the operating sounds of a demonstration model at your retailer before calling service. If a service call is placed and the sounds are normal you will be charged for the visit.

## environmental tips

Energy saving

- If it is possible, always put the lids on the cookware.
- Put cookware on a cooking zone before you start it.

Hints and Tips for Hob<sup>2</sup>Hood function

NOTE: H2H functionality requires pairing with a compatible rangehood within the Electrolux group of brands.

When you operate the hob with Hob2Hood function:

- Protect the hood panel from direct sunlight.
- Do not spot halogen light on the hood panel.
- Do not cover the hob panel.
- Do not interrupt the signal between the hob and the hood (for example with a hand or a cookware handle).

(Hood in the picture is only an example).

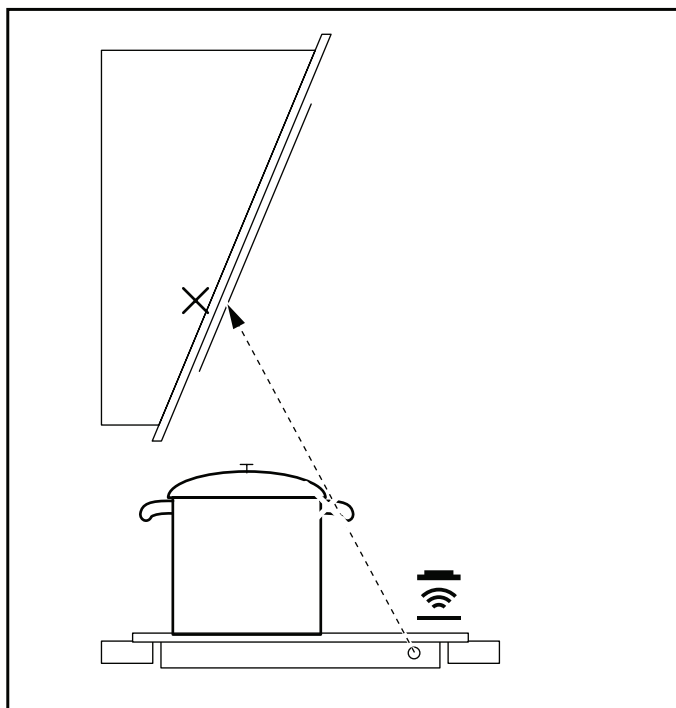

## IMPORTANT

It may happen that other remote controlled appliances may block the signal. To avoid it do not operate the remote of the appliance and the hob at the same time.

Rangehoods with the Hob<sup>2</sup>Hood function

To find the full range of rangehoods which work with this function refer to our consumer website. The Electrolux rangehoods that work with this function must have the symbol 

### The Examples of cooking applications

The data in the table is for guidance only.

Heat setting	Use	Time	Hint
1	Keep food warm	As required	Keep cookware covered
1-2	Hollandaise sauce, melt: butter, chocolate and gelatine	5-25mins	Stir from time to time
1-2	Solidify: fluffy omelettes and baked eggs	10-40mins	Keep cookware covered
2-3	Simmer rice and milk based dishes and heating up ready-cooked meals	25-50min	Don't allow to dry out
3-4	Steam vegetables, fish and meat	20-45min	Add a tablespoon of water
4-5	Steam potatoes	20-60min	Use no more than 1/4 cup of water and 750g of potatoes
4-5	Cook larger quantities of food, stews and soups	60-150mins	Use up to 3 cups of water
6-7	Gentle fry: escalope, veal cordon bleu, cutlets, rissoles, sausages, liver, roux, eggs, pancakes and donuts	As required	Turn half way through cook
7-8	Heavy fry, hash browns, loin steaks, steaks	5-15mins	Turn half way through cook
9	Boil large quantities of water, cook pasta, sear meat (goulash, pot roast), deep-fry chips	-	-

# care and cleaning

Clean the appliance after each use. Always use cookware with clean bottom.



warning

Sharp objects and abrasive cleaning agents can cause damage to the appliance. For your safety, do not clean the appliance with steam cleaners or high-pressure cleaners.

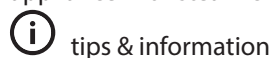









tips & information

Scratches or dark stains on the glass ceramic cause no effect on how the appliance operates.

To remove the dirt:

1. • Remove immediately: melted plastic, plastic foil, and food with sugar. If not, the dirt can cause damage to the appliance. Use a special scraper for the glass. Put the scraper on the glass surface at an acute angle and move the blade on the surface.
  - Remove after the appliance is sufficiently cool: limescale rings, water rings, fat stains, shiny metallic discolourations. Use ceramic glass cleaning agent and sealing agent for best cleaning results of stubborn stains.
2. Clean the appliance with a moist cloth and some detergent.
3. At the end rub the appliance dry with a clean cloth.

## How to resolve problems with your cooktop

PROBLEM	POSSIBLE CAUSE AND REMEDY
You can't activate the cooktop or operate it.	<ul style="list-style-type: none"> <li>• Activate the appliance again and set the heat setting in 10 seconds.</li> <li>• You touched 2 or more sensor fields at the same time. Only touch one sensor field.</li> <li>• There is water or fat stains on the control panel. Clean the control panel.</li> </ul>
The cooktop deactivates.	An object has been placed on the  button. Remove the object from the sensor field.
The residual heat indicator does not come on.	The cooking zone is not hot because it operated only for a short time. If the cooking zone is hot, contact our Customer Care team.
The sensor fields become hot.	The cookware is too large or you put it too near to the controls. Put large cookware on the rear cooking zones if it is necessary.
 comes on	The Automatic Switch Off is in operation. Deactivate the appliance and activate it again.
 comes on	<ul style="list-style-type: none"> <li>• No cookware on the cooking zone. Put cookware on the cooking zone.</li> <li>• Not correct cookware. Use the correct cookware.</li> <li>• The diameter of the bottom of the cookware is too small for the cooking zone. Move cookware to a smaller cooking zone.</li> </ul>
 and number comes on	There is an error in the appliance. Disconnect the appliance from the electrical supply for some time. Disconnect the fuse from the electrical system of the house. Connect again. If  comes on again, contact our Customer Care team.
 comes on	The Automatic Switch Off operates when the cookware on the appliance boils dry. Deactivate the appliance. Remove the hot cookware. After approximately 30 seconds, activate the cooking zone again.  will disappear from the display but the residual heat indicator will be shown until the cookware and appliance has sufficiently cooled down. Refer to the Cookware section for correct cooking temperatures.
Red rings, limescale or water rings, shiny metallic or other discolouration, scratches/shadows, bubbles or other miscellaneous marks or stains on ceramic glass cooktop surface.	Cooktop surface has not been cleaned correctly. Cleaning/maintenance of the cooktop surface is not covered under warranty. If a service call is placed to clean the cooktop you will be charged for the visit. Use ceramic glass cleaning agent and sealing agent for best cleaning results of stubborn stains.
Pitting of ceramic glass surface.	Spills of liquid with high sugar content. These types of spills must be removed immediately with a special scraper for the glass. If not permanent damage to the cooktop glass can occur which is not covered under warranty.
The heat setting changes between two levels.	The power management is activated. Refer to 'Power management'
 comes on	The Child Safety Lock device or the Lock function operates. Refer to chapter 'Operating instructions'

If you tried the above solutions and cannot repair the problem, speak to your dealer or our Customer Care team. Give the data from the rating plate, three digit letter code for the ceramic glass (it is in the corner of the glass surface) and an error message that comes on. Make sure, you operated the

appliance correctly. If not the servicing by a customer service technician or dealer will not be free of charge, also during the warranty period. The instructions about the customer service and conditions of guarantee are in the guarantee booklet.

## TROUBLESHOOTING

PROBLEM	POSSIBLE CAUSE AND REMEDY	REMEDY
You cannot activate or operate the hob.	The hob is not connected to an electrical supply or it is connected incorrectly.	Check if the hob is correctly connected to the electrical supply. Refer to the connection diagram.
	The fuse is blown.	Make sure that the fuse is the cause of the malfunction. If the fuse is blown again and again, contact a qualified electrician.
	You do not set the heat setting for 10 seconds.	Activate the hob again and set the heat setting in less than 10 seconds.
	You touched 2 or more sensor fields at the same time.	Touch only one sensor field.
	There is water or fat stains on the control panel.	Clean the control panel.
An acoustic signal sounds and the hob deactivates. An acoustic signal sounds when the hob is deactivated.	You put something on one or more sensor fields.	Remove the object from the sensor fields.
The hob deactivates.	You put something on the sensor field.	Remove the object from the sensor field.
Residual heat indicator does not come on.	The zone is not hot because it operated only for a short time or the sensor is damaged.	If the zone operated sufficiently long to be hot, speak to an Authorised Service Centre.
Hob <sup>2</sup> Hood does not work.	You covered the control panel.	Remove the object from the control panel.
	You use a very tall pot which blocks the signal.	Use a smaller pot, change the cooking zone or operate the hood manually.
Automatic Heat Up does not operate.	The zone is hot.	Let the zone become sufficiently cool.
	The highest heat setting is set.	The highest heat setting has the same power as the function.
The heat setting changes between two levels.	Power management operates.	Refer to "Daily use".
The sensor fields become hot.	The cookware is too large or you put it too near to the controls.	Put large cookware on the rear zones, if possible.
There is no sound when you touch the panel sensor fields.	The sounds are deactivated.	Activate the sounds. Refer to "Daily use".
 comes on.	Child Safety Device or Lock operates.	Refer to "Daily use".
 comes on.	There is no cookware on the zone.	Put cookware on the zone.
	The cookware is unsuitable.	Use suitable cookware. Refer to "Hints and tips".
	The diameter of the bottom of the cookware is too small for the zone.	Use cookware with correct dimensions. Refer to "Technical data".
 and  appear alternately	The power is too low due to unsuitable cookware or an empty pot.	"Use the appropriate type of cookware. Refer to "Hints and Tips" and "Technical Data". Do not activate any zone with an empty pot on it."
 and a number come on.	There is an error in the hob.	Deactivate the hob and activate it again after 30 seconds. If  comes on again, disconnect the hob from the electrical supply. After 30 seconds, connect the hob again. If the problem continues, speak to an Authorised Service Centre.
You can hear a constant beep noise.	The electrical connection is incorrect.	Disconnect the hob from the electrical supply. Ask a qualified electrician to check the installation.

# environmental concerns

The symbol  on the product or on its packaging indicates that this product may not be treated as household waste. Instead it should be taken to the appropriate collection point for the recycling of electrical and electronic equipment.

By ensuring this product is disposed of correctly, you will help prevent potential negative consequences for the environment and human health, which could otherwise be caused by inappropriate waste handling of this product.

For more detailed information about recycling of this product, please contact your local council, your household waste disposal service or the shop where you purchased the product.



environmental tips

## Packaging material

The packaging materials are friendly to the environment and can be recycled. The plastic components are identified by marking: >PE<,>PS<, etc. Discard the packaging materials as household waste at the waste disposal.







# Electrolux Warranty

FOR SALES IN AUSTRALIA AND NEW ZEALAND  
APPLIANCE: BUILT-IN OVENS, COOKTOPS AND  
FREESTANDING COOKERS

**This document sets out the terms and conditions of the product warranties for Electrolux Appliances. It is an important document. Please keep it with your proof of purchase documents in a safe place for future reference should there be a manufacturing defect in your Appliance. This warranty is in addition to other rights you may have under the Australian Consumer Law.**

## 1. In this warranty:

- (a) 'ACL' or 'Australian Consumer Law' means Schedule 2 to the Competition and Consumer Act 2010;
- (b) 'Appliance' means any Electrolux product purchased by you and accompanied by this document;
- (c) 'ASC' means Electrolux's authorised serviced centres;
- (d) 'Chef' and 'Westinghouse' are brands controlled by Electrolux Home Products Pty Ltd of 163 O'Riordan Street, Mascot NSW 2020, ABN 51 004 762 341 in respect of Appliances purchased in Australia and Electrolux (NZ) Limited (collectively "Electrolux") of 3-5 Niall Burgess Road, Mount Wellington, in respect of Appliances purchased in New Zealand;
- (e) 'Warranty Period' means the period specified in clause 3 of this warranty;
- (f) 'you' means the purchaser of the Appliance not having purchased the Appliance for re-sale, and 'your' has a corresponding meaning.

**2. Application:** This warranty only applies to new Appliances, purchased and used in Australia or New Zealand and is in addition to (and does not exclude, restrict, or modify in any way) other rights and remedies under a law to which the Appliances or services relate, including any non-excludable statutory guarantees in Australia and New Zealand.

**3. Warranty Period:** Subject to these terms and conditions, this warranty continues in Australia for a period of 24 months and in New Zealand for a period of 24 months, following the date of original purchase of the Appliance.

**4. Repair or replace warranty:** During the Warranty Period, Electrolux or its ASC will, at no extra charge if your Appliance is readily accessible for service, without special equipment and subject to these terms and conditions, repair or replace any parts which it considers to be defective. Electrolux may, in its absolute discretion, choose whether the remedy offered for a valid warranty claim is repair or replacement. Electrolux or its ASC may use refurbished parts to repair your Appliance. You agree that any replaced Appliances or parts become the property of Electrolux.

**5. Travel and transportation costs:** Subject to clause 7, Electrolux will bear the reasonable cost of transportation, travel and delivery of the Appliance to and from Electrolux or its ASC. Travel and transportation will be arranged by Electrolux as part of any valid warranty claim.

**6. Proof of purchase** is required before you can make a claim under this warranty.

**7. Exclusions:** You may not make a claim under this warranty unless the defect claimed is due to faulty or defective parts or workmanship. This warranty does not cover:

- (a) light globes, batteries, filters or similar perishable parts;
- (b) parts and Appliances not supplied by Electrolux;
- (c) cosmetic damage which does not affect the operation of the Appliance;

- (d) damage to the Appliance caused by:
  - (i) negligence or accident;
  - (ii) misuse or abuse, including failure to properly maintain or service;
  - (iii) improper, negligent or faulty servicing or repair works done by anyone other than an Electrolux authorised repairer or ASC;
  - (iv) normal wear and tear;
  - (v) power surges, electrical storm damage or incorrect power supply;
  - (vi) incomplete or improper installation;
  - (vii) incorrect, improper or inappropriate operation;
  - (viii) insect or vermin infestation;
  - (ix) failure to comply with any additional instructions supplied with the Appliance;

In addition, Electrolux is not liable under this warranty if:

- (a) the Appliance has been, or Electrolux reasonably believes that the Appliance has been, used for purposes other than those for which the Appliance was intended, including where the Appliance has been used for any non-domestic purpose;
- (b) the Appliance is modified without authority from Electrolux in writing;
- (c) the Appliance's serial number or warranty seal has been removed or defaced

**8. How to claim under this warranty:** To enquire about claiming under this warranty, please follow these steps:

- (a) carefully check the operating instructions, user manual and the terms of this warranty;
- (b) have the model and serial number of the Appliance available;
- (c) have the proof of purchase (e.g. an invoice) available;
- (d) telephone the numbers shown below.

**9. Australia:** For Appliances and services provided by Electrolux in Australia: Electrolux goods come with guarantees that cannot be excluded under the Australian Consumer Law. You are entitled to a replacement or refund for a major failure and for compensation for any other reasonably foreseeable loss or damage. You are also entitled to have the Appliance repaired or replaced if the Appliance fails to be of acceptable quality and the failure does not amount to a major failure. 'Acceptable quality' and 'major failure' have the same meaning as referred to in the ACL.

**10. New Zealand:** For Appliances and services provided by Electrolux in New Zealand, the Appliances come with a guarantee by Electrolux pursuant to the provisions of the Consumer Guarantees Act, the Sale of Goods Act and the Fair Trading Act. Where the Appliance was purchased in New Zealand for commercial purposes the Consumer Guarantee Act does not apply.

**11. Confidentiality:** You accept that if you make a warranty claim, Electrolux and its agents including ASC may exchange information in relation to you to enable Electrolux to meet its obligations under this warranty.

## Important Notice

Before calling for service, please ensure that the steps listed in clause 8 above have been followed.

<b>AUSTRALIA</b>	<b>FOR SERVICE</b> or to find the address of your nearest authorised service centre in Australia <b>PLEASE CALL 13 13 49</b> <small>For the cost of a local call</small>	<b>FOR SPARE PARTS</b> or to find the address of your nearest spare parts centre in Australia <b>PLEASE CALL 13 13 50</b> <small>For the cost of a local call</small>
<b>NEW ZEALAND</b>	<b>FOR SERVICE</b> or to find the address of your nearest authorised service centre in New Zealand <b>PLEASE CALL 0800 10 66 10</b>	<b>FOR SPARE PARTS</b> or to find the address of your nearest spare parts centre in New Zealand <b>PLEASE CALL 0800 10 66 20</b>

# LIKE TO KNOW MORE?



Customer Care Centre

Contact us if you need more help

## Australia

phone: ..... 13 13 49

email: ..... [customercare@electrolux.com.au](mailto:customercare@electrolux.com.au)

website: ..... [chef.com.au](http://chef.com.au)

**WE ARE PART OF THE ELECTROLUX FAMILY.  
TO ADD A TOUCH OF PROFESSIONAL INSPIRATION  
TO YOUR HOME, VISIT ELECTROLUX.COM**

© 2020 Electrolux Home Products Pty Ltd.  
ABN 51 004 762 341  
ANC : A19136406 Rev.A  
C\_MAN\_Induction\_Nov20

