

# Operating and installation instructions

## Rangehood



To prevent the risk of accidents or damage to the appliance, it is **essential** to read these instructions before it is installed and used for the first time.

# Contents

---

<b>Warning and Safety instructions</b> .....	4
<b>Caring for the environment</b> .....	13
<b>Guide to the appliance</b> .....	14
<b>Description of the functions</b> .....	16
<b>Operation</b> .....	17
Switching the fan on.....	17
Selecting a power setting.....	17
Fan run-on after cooking .....	17
Switching the fan off .....	17
Switching the cooktop lighting on/off .....	17
Power management .....	17
Switching Power management on/off .....	18
Safety switch-off .....	18
<b>Energy saving tips</b> .....	19
<b>Cleaning and care</b> .....	20
Housing .....	20
Grease filters .....	21
NoSmell active charcoal filter .....	24
Disposing of the charcoal filter .....	24
Reactivatable charcoal filter .....	24
Changing a lamp .....	25
<b>Installation</b> .....	26
Before installation.....	26
Protective foil.....	26
Installation instructions.....	26
Dismantling.....	26
Assembly parts.....	27
Appliance dimensions .....	29
Safety distance (S) .....	30
Installation recommendations .....	31
Drilling diagram for wall mounting.....	31
<b>Connection for air extraction</b> .....	32
Condensate trap.....	33
Silencer.....	33
<b>Electrical connection</b> .....	35

# Contents

---

<b>After sales service and warranty</b> .....	36
Position of the data plate .....	36
Warranty .....	36
<b>Technical data</b> .....	37
Note for test institutes .....	37

## Warning and Safety instructions

---

This appliance complies with all relevant local and national safety requirements. Inappropriate use can, however, lead to personal injury and damage to property.

To avoid the risk of accidents and damage to the appliance, please read these instructions carefully before using it for the first time. They contain important notes on the safety, installation, use and maintenance of the appliance. Miele cannot be held liable for non-compliance with these instructions.

Keep these instructions in a safe place and ensure that all users are familiar with the contents. Pass them on to any future owner of the appliance.

### Correct application

- ▶ This rangehood is designed for domestic use and for use in similar environments by guests in hotel or motel rooms, bed & breakfasts and other typical living quarters. This does not include common/shared facilities or commercial facilities within hotels, motels or bed & breakfasts.
- ▶ The appliance is not suitable for outdoor use.
- ▶ It must only be used to extract vapours and remove odours from cooking.  
Any other usage is at the owner's risk. Miele cannot be held liable for damage resulting from incorrect or improper use or operation.
- ▶ Where a recirculation rangehood is fitted above a gas cooktop, please ensure that there is an adequate supply of fresh air into the room in which it is installed. Please seek the advice of a qualified gas fitter if necessary.

## Warning and Safety instructions

---

▶ This appliance is not intended for use by persons (including children) with reduced physical, sensory or mental capabilities, or lack of experience and knowledge, unless they have been given supervision or instruction concerning its use by a person responsible for their safety, and are able to recognise the dangers of misuse.

### **Safety with children**

▶ Young children must not be allowed to use this appliance.

▶ Older children may only use the appliance when its operation has been clearly explained to them and they are able to use it safely, recognising the dangers of misuse.

▶ Cleaning work may only be carried out by older children under the supervision of an adult.

▶ Children should be supervised near the appliance. Ensure that they do not play with the appliance.

▶ The cooktop lighting is very intense.

Ensure, in particular, that babies/small children do not look directly at the light.

▶ **Danger of suffocation!**

Whilst playing, children may become entangled in packaging material (such as plastic wrapping) or pull it over their head with the risk of suffocation. Keep packaging material away from children.

# Warning and Safety instructions

---

## Technical safety

- ▶ Unauthorised installation, maintenance and repairs can cause considerable danger for the user. Installation, maintenance and repairs must only be carried out by a Miele authorised technician.
- ▶ A damaged appliance can be dangerous. Check it for visible signs of damage. Do not use a damaged appliance.
- ▶ The electrical safety of this appliance can only be guaranteed when continuity is complete between it and an effective earthing system. It is most important that this basic safety requirement is present and tested regularly and, where there is any doubt, the household wiring system should be inspected by a qualified electrician.
- ▶ Reliable and safe operation of this rangehood can only be assured if it has been connected to the mains electricity supply.
- ▶ The connection data (voltage and frequency) on the data plate of the rangehood must match the mains electricity supply in order to avoid the risk of damage to the rangehood.  
Compare this before connecting the appliance to the mains electricity. If in doubt, consult a qualified electrician.
- ▶ Do not connect the appliance to the mains electricity supply by a multi-socket unit or an extension lead. Extension leads are a fire hazard and do not guarantee the required safety of the appliance.

## Warning and Safety instructions

---

▶ For safety reasons, this appliance may only be used after it has been built in.

▶ This rangehood must not be installed and operated in mobile installations (e.g. on a ship).

▶ Tampering with electrical connections or components and mechanical parts is highly dangerous to the user and can cause operational faults.

Only open the housing as described in the instructions given in the installation sheet and in the “Cleaning and care” section of this booklet. Under no circumstances should any other parts of the housing be opened.

▶ The manufacturer's warranty will be invalidated if the appliance is not repaired by a Miele approved service technician.

▶ Faulty components must only be replaced by genuine Miele spare parts. The manufacturer can only guarantee the safety of the appliance when Miele replacement parts are used.

▶ If the mains connection cable is damaged, it must only be replaced by a Miele authorised service technician or suitably qualified electrician in order to avoid a hazard.

▶ During installation, maintenance and repair work, the appliance must be disconnected from the mains electricity supply. It is only completely isolated from the electricity supply when:

- the mains circuit breaker is switched off, or
- it is switched off at the wall socket and the plug is withdrawn from the socket. Do not pull the mains connection cable but the mains plug to disconnect your appliance from the mains electricity supply.

# Warning and Safety instructions

Using at the same time as other heating appliances that depend on the air from the room

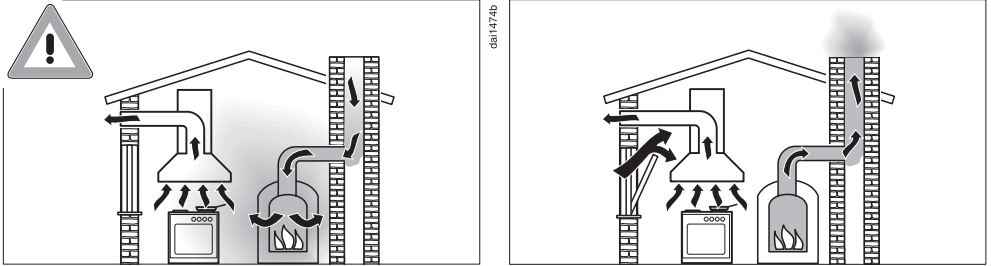

**⚠ Warning - danger of toxic fumes!**

Great care should be taken when using the rangehood at the same time and in the same room or area of the house as another heating appliance which depends on the air in the room.

Such appliances include gas, oil, wood or coal-fired boilers and heaters, continuous flow or other water heaters, gas cooktops, or ovens which draw air in from the room and duct exhaust gases out through a chimney or extraction ducting.

When used in extraction mode, with or without an external motor fitted, or in recirculation mode with a recirculation box installed outside the room, the appliance draws air in from the room in which it is installed and from neighbouring rooms.

If there is insufficient air, an underpressure will occur. The heating appliance will be starved of oxygen, impairing combustion.

Harmful gases could be drawn out of the chimney or extraction ducting back into the room, with potentially fatal consequences.



## Warning and Safety instructions

In order to ensure safe operation, and to prevent gases given off by the heating appliances from being drawn back into the room when the rangehood and the heater are in operation simultaneously, an underpressure in the room of 0.04 mbar (4 pa) is the maximum permissible.

Ventilation can be maintained by air inlets which cannot be blocked, in windows, doors or outside wall vents, or by other technical measures, such as ensuring that the rangehood can only be switched on when the heating appliance is switched off or vice versa. A ventilation brick alone is not generally sufficient to ensure safe ventilation.

The overall ventilation condition of the dwelling must be taken into account. If in any doubt, the advice of a competent builder, or for gas a qualified gas fitter (registered with an official gas safety body in accordance with national safety regulations), must be sought.

If the rangehood is used in recirculation mode, where the air is directed back into the room in which it is located, operating a heating appliance which depends on the room air at the same time is not hazardous.

## Warning and Safety instructions

---

### Correct use

- ▶ Never use an open flame beneath the rangehood. To avoid the danger of fire, do not flambé or grill over an open flame. When switched on, the rangehood could draw flames into the filter. Fat deposits could ignite, presenting a fire hazard.
- ▶ The rangehood can become damaged when exposed to excessive heat.
  - When using the rangehood over a gas cooktop, ensure that any burners in use are always covered by a pan. Switch the cooking zone off when a pan is removed, even for a short time.
  - Select a pan which is suitable for the size of the burner.
  - Regulate the flame so that it does not burn up the sides of the pan.
  - Avoid overheating the pan (e.g. when cooking with a wok).
- ▶ Always switch the rangehood on when a cooking zone is in use, otherwise condensation may collect in the rangehood, which could cause corrosion.
- ▶ Overheated oil and fat can ignite, causing fire damage to the rangehood. When cooking with oil or fat, chip pans and deep fat fryers etc., do not leave the pans unattended. Similarly, never leave an open grill unattended when grilling.

## Warning and Safety instructions

---

- ▶ Do not use the rangehood without the filters in place. This way you will avoid the risk of grease and dirt getting into the appliance and hindering its smooth operation.
- ▶ The rangehood can get very hot during cooking due to heat rising from the cooktop.  
Do not touch the housing or the grease filters until the rangehood has cooled down.
- ▶ This rangehood is not suitable for placing objects on.

### Correct installation

- ▶ Refer to the cooktop manufacturer's instructions as to whether a rangehood may be operated above the cooktop.
- ▶ Safety regulations prohibit the fitting of a rangehood over solid fuel stoves.
- ▶ An insufficient safety distance between the stovetop and the rangehood can result in damage to the rangehood.  
The minimum safety distances between the top of the stovetop and the bottom of the rangehood given in the “Installation” section of this booklet must be observed, unless the stovetop manufacturer states that a greater safety distance is required.  
If more than one cooking appliance is fitted beneath the rangehood, and they have different minimum safety distances to the rangehood, select the greater distance.
- ▶ The distances given in “Installation” must be observed when fitting the rangehood.
- ▶ Metal parts can have sharp edges which may cause injury.  
Wear gloves to protect your hands from being cut.
- ▶ All ducting, pipework and fittings must be of non-flammable material. These can be obtained from builders' merchants.

## Warning and Safety instructions

---

- ▶ The appliance must not be connected to a chimney or vent flue which is in current use for exhausting fumes from appliances burning gas or other fuels. Neither should it be connected to ducting which ventilates rooms with fireplaces.
- ▶ If exhaust air is to be extracted into a chimney or ventilation duct no longer used for other purposes, seek professional advice.

### Cleaning and care

- ▶ There is a risk of fire if cleaning is not carried out as described in these operating instructions.
- ▶ Do not use a steam cleaning appliance to clean this appliance. The steam could reach electrical components and cause a short circuit.
- ▶ In areas which may be subject to infestation by cockroaches or other vermin, pay particular attention to keeping the machine and its surroundings in a clean condition at all times. Any damage which may be caused by cockroaches or other vermin will not be covered by the machine warranty.

### Accessories

- ▶ Use only genuine original Miele spare parts. If spare parts or accessories from other manufacturers are used, the warranty will be invalidated, and Miele cannot accept liability.

### Disposal of the packing material

The transport and protective packaging has been selected from materials which are environmentally friendly for disposal, and can normally be recycled.

Recycling the packaging reduces the use of raw materials in the manufacturing process and also reduces the amount of waste in landfill sites. Ensure that any plastic wrappings, bags etc. are disposed of safely and kept out of the reach of babies and young children. Danger of suffocation.

### Disposing of your old appliance

Electrical and electronic appliances often contain valuable materials. They also contain specific materials, compounds and components, which were essential for their correct function and safety. These could be hazardous to human health and to the environment if disposed of with your domestic waste or if handled incorrectly. Please do not, therefore, dispose of your old appliance with your household waste.



Please dispose of it at your local community waste collection / recycling centre for electrical and electronic appliances. You are also responsible for deleting any personal data that may be stored on the appliance prior to disposal. Please ensure that your old appliance poses no risk to children while being stored prior to disposal.

# Guide to the appliance

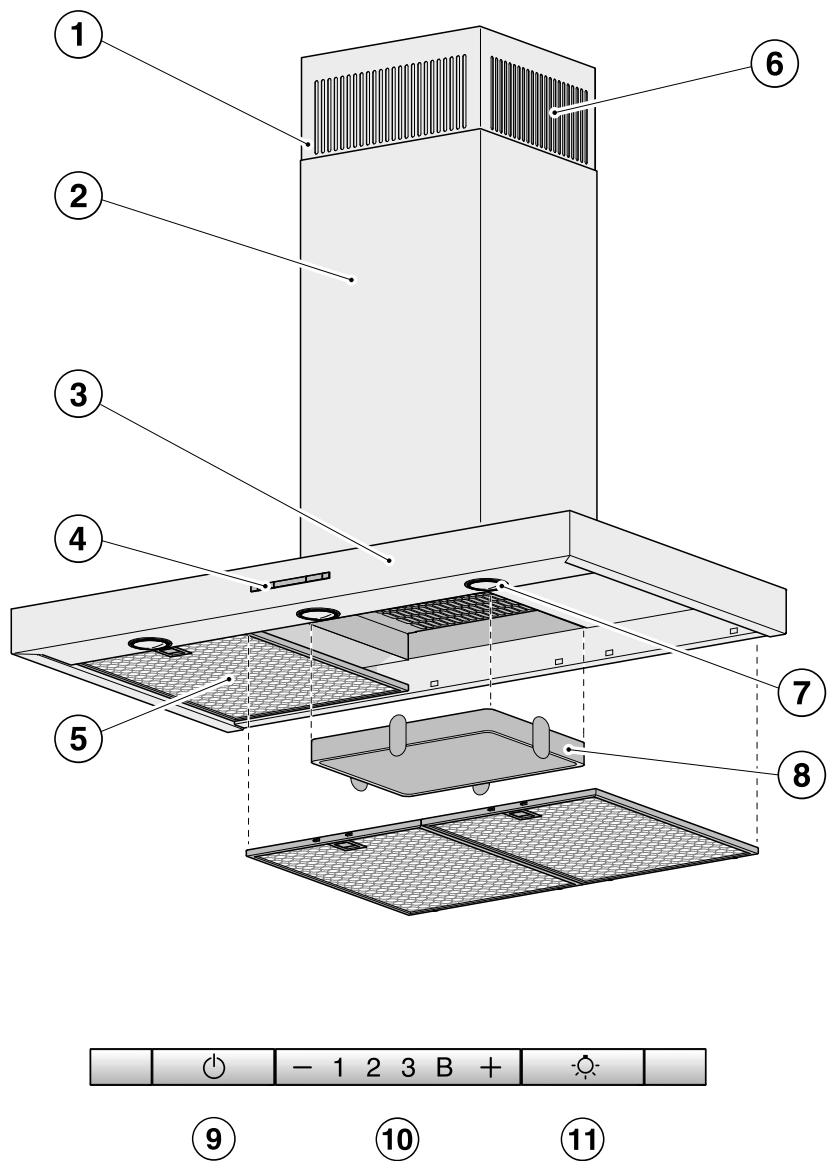

- ① Telescopic extension piece
- ② Tower
- ③ Canopy
- ④ Controls
- ⑤ Grease filters
- ⑥ Recirculation grilles  
(only for recirculation mode)
- ⑦ Cooktop lighting
- ⑧ NoSmell active charcoal filter  
(special accessory for recirculation mode)
- ⑨ On/Off touch control for the fan
- ⑩ Touch controls to select the fan power setting
- ⑪ On/Off touch control for the cooktop lighting

# Description of the functions

---

Depending on the model of the rangehood, the following options are available:

## Air extraction mode

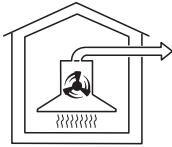

da100494a

The air is drawn in and cleaned by the grease filters and directed outside.

## Non-return flap

The non-return flap is designed to prevent the exchange of room and outside air taking place.

The flap is closed when the rangehood is switched off.

When the rangehood is switched on, the non-return flap opens for the cooking vapours to be blown directly outside.

If the on-site ventilation system does not have a non-return flap, the non-return flap supplied must be fitted.

## Recirculation mode

(available as an optional extra with a conversion kit and charcoal filter: see “Technical Data”)



da100494b

The air is drawn in and cleaned first by the grease filters and then by a charcoal filter. The cleaned air is then recirculated back into the kitchen.



## Switching the fan on

Switch the fan on as soon as you start cooking. This is to ensure that vapours are captured right from the start.

- Press the On/Off touch control .

The fan will switch on at setting **2**. The  symbol and **2** will light up in the power setting display.

## Selecting a power setting

For light to heavy cooking vapours and odours, select from power settings **1** to **3**.

For short periods of cooking food with intensive vapours and a strong aroma, e.g. when searing meat, select Booster setting **B**.

- Select the power level you want by pressing the **–** or **+** controls.

## Reducing power down from the Booster setting

If Power management is activated (default setting), the fan automatically switches back to level **3** after 5 minutes.

## Fan run-on after cooking

- It is advisable to run the fan for a few minutes after cooking has finished to neutralise any lingering vapours and odours in the air.

## Switching the fan off

- Press the On/Off touch control  to switch the fan off.

The  symbol will go out.

## Switching the cooktop lighting on/off

The cooktop lighting can be switched on and off independently of the fan.

- To do so press the lighting control .

The  symbol will light up when the cooktop lighting is switched on.

## Power management

The rangehood features a Power management system to help save energy. The fan power setting is reduced and the lighting is switched off automatically.

- If the Booster setting has been selected, the fan will automatically switch to setting **3** after 5 minutes.
- From settings **3**, **2** or **1** the power will be reduced by one setting after 2 hours and then in 30-minute stages until the fan finally switches off.
- The cooktop lighting will switch off automatically after 12 hours.



# Operation

---

## Switching Power management on/off

You can deactivate the Power management.

Keep in mind that this may increase energy consumption.

- To set this option, both the fan and the cooktop lighting must be switched off.
- Press the **–** and **+** controls at the same time for approx. 10 seconds, until the **1** lights up.
- Then press in turn:
  - the lighting control ,
  - then the **–** touch control, and
  - the lighting control  again.

If Power management is switched on, the **1** and **B** indicators light up constantly.

When it is switched off, the **1** and **B** indicators flash.

- Press **–** to switch Power management off.

The **1** and **B** indicators will flash.

- To switch it on, press **+**.

The **1** and **B** indicators will light up constantly.



- Confirm your choice with the On/Off control .

All the indicator lights will go out.

If you don't confirm your selection within 4 minutes, the rangehood will automatically revert to the previous setting.

## Safety switch-off

If Power management has been deactivated, the rangehood will switch itself off automatically after 12 hours if it has been left on (fan and cooktop lighting).

- To switch it back on press the On/Off  control or the lighting control .

This rangehood operates very efficiently and economically. The following will help you to save even more energy when using it:

- Ensure that there is sufficient ventilation in the kitchen when cooking. In extraction mode, if there is insufficient air flow the rangehood cannot operate efficiently and this causes increased operating noise levels.
- Always cook with the lowest possible setting. This produces fewer cooking vapours, so you can use a lower rangehood power level and therefore benefit from reduced energy consumption.
- Check the power level selected on the rangehood. A lower power level is generally sufficient for the majority of cooking. Only use the Booster setting when necessary.
- When a large volume of cooking vapours are being produced, switch to a high power level in good time. This is more efficient than operating the rangehood for longer to try to capture cooking vapours which have already been distributed throughout the kitchen.
- Make sure that you switch the rangehood off after use.
- Clean or change the filters at regular intervals. Heavily soiled filters reduce performance, increase the risk of fire and are unhygienic.

# Cleaning and care

 Before proceeding with any maintenance or cleaning task, the rangehood must be disconnected from the power supply (see “Warning and Safety instructions”).

## Housing

### General

 The surfaces and controls are susceptible to scratches and abrasion.

Please observe the following cleaning instructions.

- All external surfaces and controls can be cleaned using warm water with a small amount of washing-up liquid applied with a well wrung-out soft sponge or cloth.

 Do not use too much water when cleaning the controls. Water could penetrate into the electronics and cause damage.

- After cleaning, wipe the surfaces dry using a soft cloth.

Do not use:

- cleaning agents containing soda, acids, chlorides or solvents,
- abrasive cleaning agents, e.g. powder cleaners or cream cleaners and abrasive sponges, as well as pot scourers or sponges which have been used previously with abrasive cleaning agents. These will damage the surface material.

### Important for appliances with stainless steel surfaces

(This information does not apply to the controls)

- Stainless steel surfaces can be cleaned with a proprietary non-abrasive cleaning agent designed specifically for use on stainless steel, e.g. Original Miele ceramic and stainless steel cooktop cleaner.
- To help prevent re-soiling, a proprietary conditioning agent for stainless steel (Original Miele Care product for stainless steel) can also be used. Apply sparingly with a soft cloth following the instructions on the packaging.

### Important for appliances with lacquered housing

(special order finish)

- Observe the general notes on cleaning earlier in this section.

Minor scratches on the surface are inevitable when cleaning the housing. Depending on the lighting in the kitchen, this may negatively affect the appliance's appearance.

## Important for the controls

Do not leave soiling on the controls for any length of time. Otherwise they may suffer discolouration or damage. Remove any soiling immediately.

- Observe the general notes on cleaning earlier in this section.

Do not use stainless steel cleaning agents on the controls.

## Grease filters

The re-usable metal grease filters in the appliance remove solid particles (grease, dust, etc.) from the kitchen vapours, preventing soiling of the rangehood.

The grease filters must be cleaned at regular intervals.

Heavily soiled grease filters hinder air extraction and will lead to increased levels of soiling in the rangehood and in the kitchen.



Fire hazard!

Oversaturated grease filters are a fire hazard.

Clean the grease filters at regular intervals.

## Grease filter cleaning intervals

Accumulated grease solidifies over a longer period of time and makes cleaning more difficult. The grease filters should therefore be cleaned every 3 to 4 weeks.

## Removing the grease filter



When handling the grease filter, be careful not to drop it.

This can result in damage to the filter and the cooktop below.

Make sure you hold the filter securely at all times when handling it.

# Cleaning and care

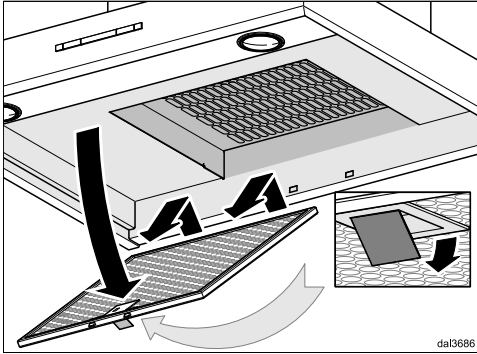

- To take out the grease filter, release the locking clip on the filter, lower the filter approx. 45°, unhook it at the back and remove it.

## Cleaning the grease filters by hand

- Clean the filters with a soft nylon brush in a mild solution of hot water and a small amount of washing-up liquid. Do not use undiluted washing up liquid.

## Unsuitable cleaning agents

Unsuitable cleaning agents can cause damage to the surface of the filters if used regularly.

Do not use:

- cleaning agents containing descaling agents,
- powder cleaners or cream cleaners,
- aggressive all-purpose cleaning agents or spray cleaners for grease,
- oven sprays.

## Cleaning the grease filters in the dishwasher

- Place the grease filters upright or slightly inclined in the lower basket. Ensure the spray arm is not obstructed.
- Use a standard household dishwasher detergent.
- Select a dishwasher programme with a wash temperature between 50 °C and 65 °C.

Depending on the detergent used, cleaning the filters in the dishwasher may cause the inside filter surfaces to become discoloured. This will not affect the functioning of the grease filters in any way.

## After cleaning

- After cleaning, leave the filters to dry on an absorbent surface before refitting them.
- When removing the filters for cleaning, also clean off any residues of oil or fat from the now accessible housing to prevent the risk of these catching fire.
- Replace the grease filters, making sure that the locking clips are facing down towards the cooktop.

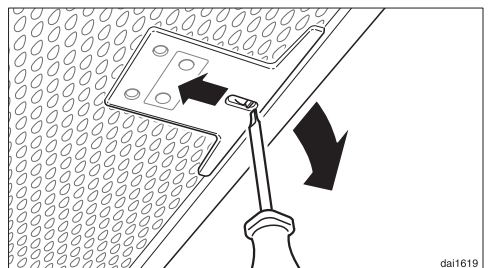

- If a grease filter is inadvertently refitted upside down, insert a small screwdriver blade into the slit to disengage the clip.

# Cleaning and care

## NoSmell active charcoal filter

With recirculation mode, a charcoal filter must be fitted in addition to the grease filters. The charcoal filter is designed to absorb cooking odours.

The charcoal filter is fitted in the canopy above the grease filters.

### Fitting/replacing the charcoal filter

- Remove the grease filters before fitting or replacing the charcoal filter.
- Take the charcoal filter out of its packaging.

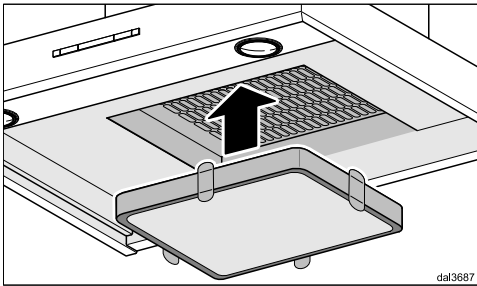

- Press the charcoal filter into the frame.
- Refit the grease filters.

## When to change the NoSmell active charcoal filter

- Replace the charcoal filter when it no longer absorbs kitchen odours effectively.  
It should be replaced at least every 6 months.

### Disposing of the charcoal filter

- The used charcoal filter can be disposed of with the normal household waste.

### Reactivatable charcoal filter

A reactivatable charcoal filter is available for this rangehood. By reactivating it in an oven, it can be reused several times.

- It is supplied with its own installation and usage instructions which must be observed.

Charcoal filters are available to order via the Miele online shop (see end of this booklet for contact details) or directly from Miele.

The charcoal filters are listed under “Technical data” at the back of this booklet.



## Changing a lamp

Use only the lamps specified for use with this appliance.

Other lamps, e.g. halogen lamps, may be damaged due to the high generation of heat.

The lamps should be replaced with the following:

Manufacturer ..... EGLO  
Lamp type ..... GU10  
Specification..... 12981  
Wattage ..... 3 W  
ILCOS D Code..... DR-3-H-GU10-50/56

These lamps are available from Miele.

- Switch off the fan and the lighting.

 The lamps can get very hot when in use.

Allow the lamps to cool down for a few minutes before changing them.

- Disconnect the rangehood from the electricity supply before replacing the lamps (see “Warning and Safety instructions”).

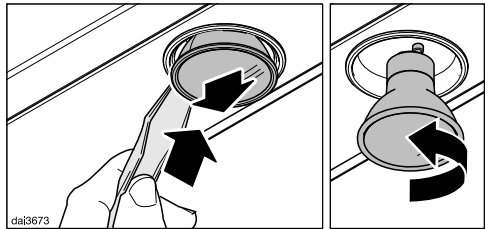

- Insert the lever supplied into the gap between the lamp and the lamp holder.

The lamp will drop downwards.

- Grip the lamp, turn it anti-clockwise and take it out.
- Screw the new lamp into the socket and push it upwards. Please follow the manufacturer's instructions.

# Installation

## Before installation

 Before installation, it is important to read the information given on the following pages as well as the “Warning and Safety instructions” at the beginning of this booklet.

## Protective foil

The housing components have protective foil around them to prevent them from transport damage.

- Please remove this foil before fitting the housing components. It can be peeled off easily.

## Installation instructions

See enclosed installation sheet for instructions on how to install this appliance.

 Failure to install the screws or fixing device in accordance with these instructions may result in electrical hazards.

## Dismantling

Should the appliance ever need to be dismantled, follow the installation instructions in reverse order as described on the installation sheet. A lever is supplied to assist with the removal of the tower.

- Unscrew the two fixing screws on the tower.

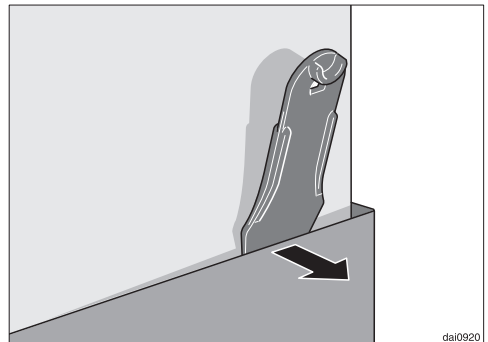

- Push the lever between the tower and the extension piece.
- Lever the tower out of its fixings.

## Assembly parts

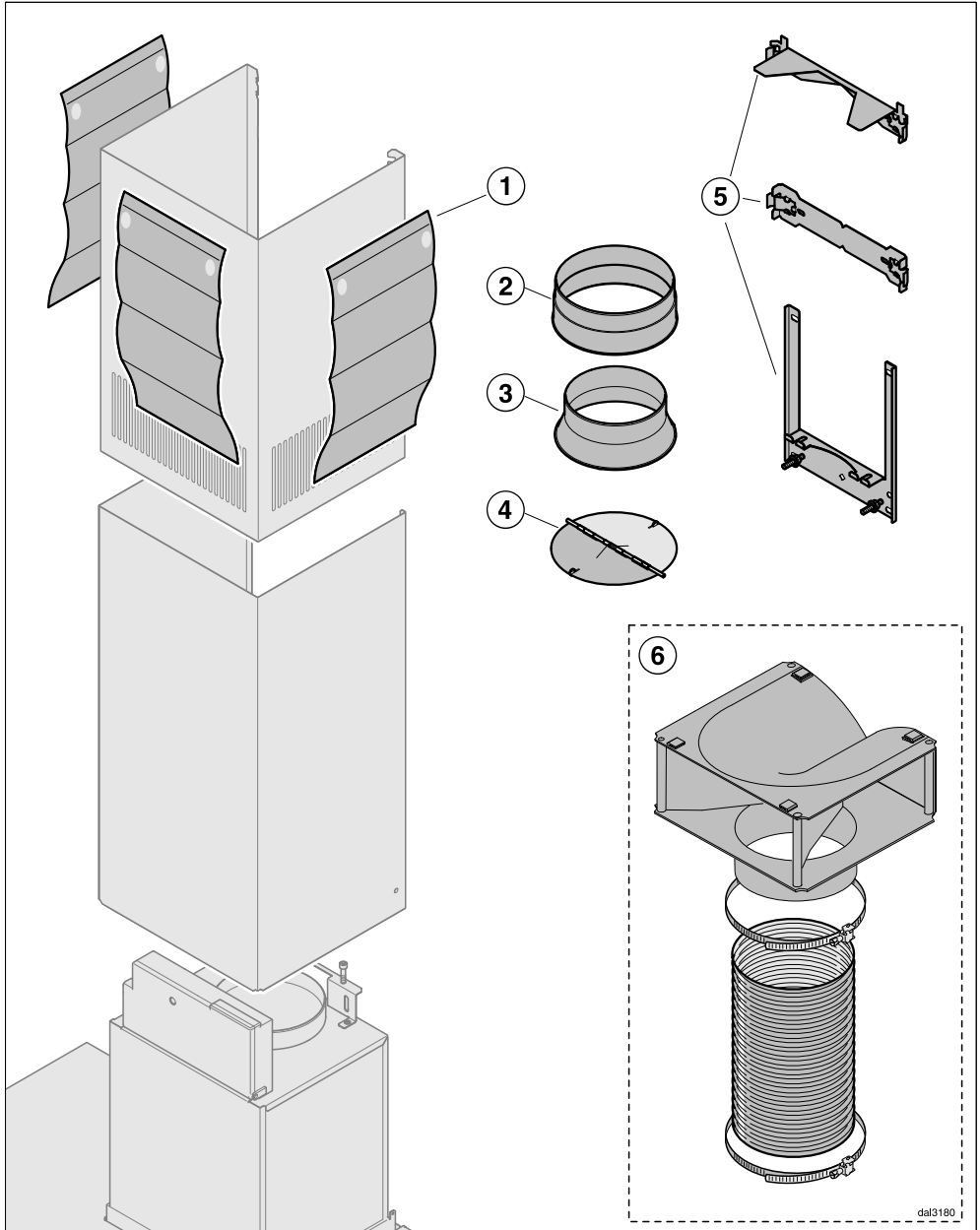

# Installation

- ① **3 protective sheets**  
for use when fitting the tower.
- ② **1 exhaust connection**  
for exhaust ducting  $\varnothing$  150 mm.
- ③ **1 reducing collar**  
for exhaust ducting  $\varnothing$  125 mm.
- ④ **1 non-return flap**  
for installation in the exhaust connection on the motor unit (not for recirculation mode). The non-return flap may already be fitted depending on model.
- ⑤ **Wall bracket**  
for securing the rangehood to the wall.
- ⑥ **Conversion kit for recirculation mode**  
including directional unit, flexible aluminium hose and hose clips (the conversion kit is not supplied. It is available as an optional extra - see "Technical data").

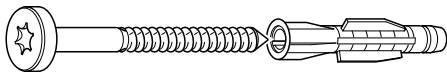

5x60mm-D30x8x50

**8 screws, 5 x 60 mm** and  
**8 plugs, 8 x 50 mm**  
for securing the wall bracket.

 The screws and plugs are designed for use in solid walls only. For other types of wall construction, alternative fixings will be required. Make sure the wall is able to take the weight of the rangehood.



**2 x M 6 self-tapping nuts**  
for securing the canopy.



**2 screws 3.9 x 7.5 mm**  
for securing the tower.

Keep the following in a safe place:

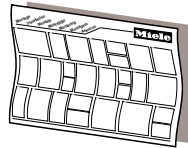

## Installation instructions

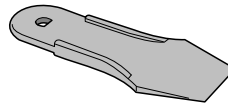

**1 lever**  
for replacing lamps and for dismantling the tower.

00031862

00265130

dha3mie

00033716

## Appliance dimensions

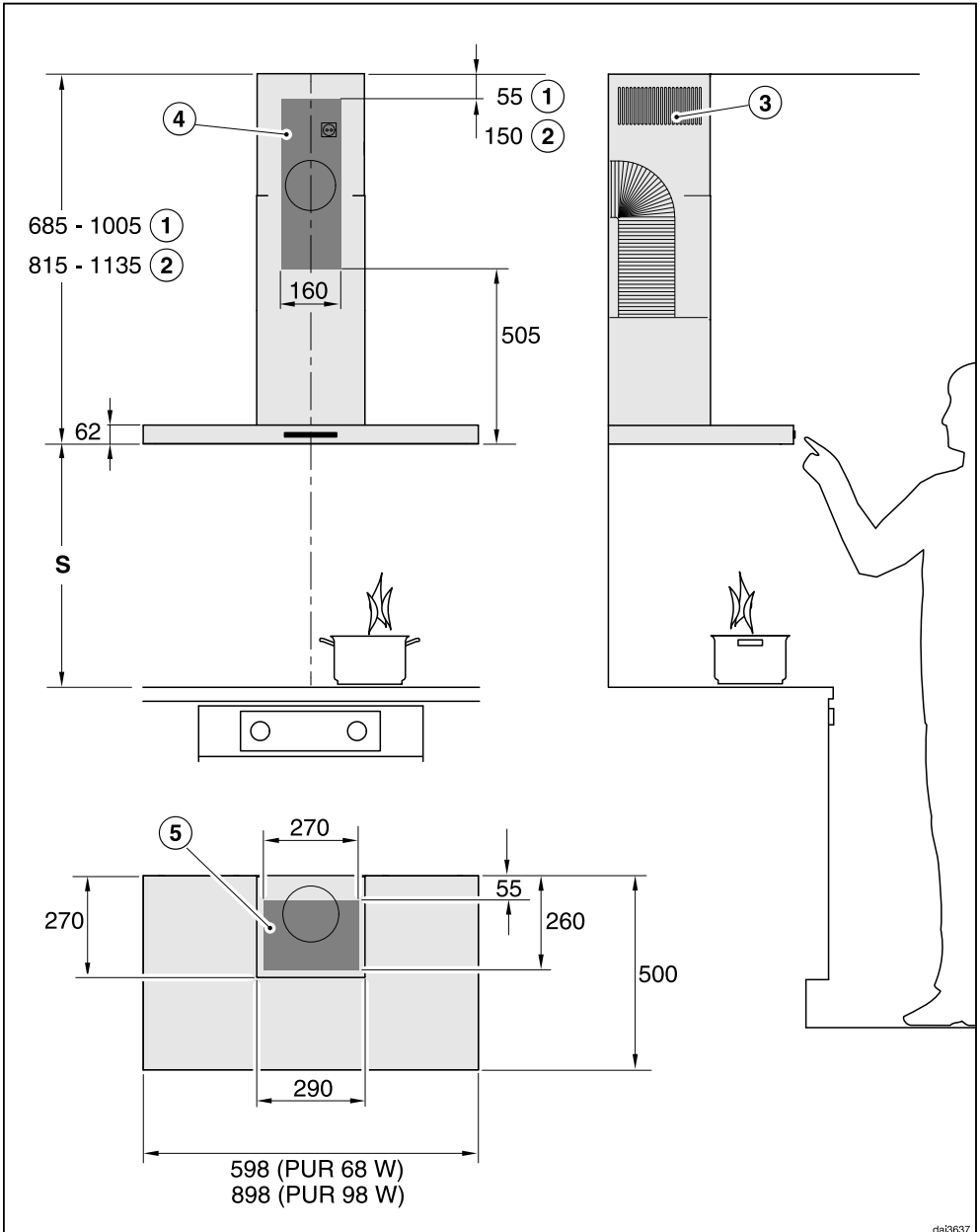

da|3637

The drawing is not to scale.

# Installation

- ① Extraction
- ② Recirculation
- ③ Ventilation grille positioned at the top for recirculation
- ④ ⑤ (only ④ is required for recirculation mode rangehoods): The shaded area represents the wall or ceiling area for the vent cut-out and for fitting the connection socket. Recirculation mode rangehoods only require an electrical connection socket.

Connection for air extraction  $\varnothing$  150 mm, or  $\varnothing$ 125 mm with reducing collar.

## Safety distance (S)

The minimum distances between the cooking surface of a cooktop (pan support(s) for gas models) and the bottom of the rangehood are as follows, unless a greater distance is specified by the manufacturer of your cooking appliance. See also “Warning and Safety instructions”.

Cooking appliance	Minimum distance S
Electric cooktop	600 mm (AU, NZ) 450 mm (HK, MY, SG, TH)
Electric grill, deep fat fryer (electric)	650 mm
Multi-burner gas cooktop with maximum 45.4 MJ/h total output, with no burner having a greater output than 16.2 MJ/h.	650 mm
Multi-burner gas cooktop with total output greater than 45.4 MJ/h, but with a maximum of 77.8 MJ/h, with no burner having a greater output than 17.3 MJ/h.	760 mm
Multi-burner gas cooktop with total output greater than 77.8 MJ/h, with a single burner having a greater output than 17.3 MJ/h.	Not possible
Single burner gas cooktop with a maximum output of 21.6 MJ/h.	650 mm
Single burner gas cooktop with an output greater than 21.6 MJ/h, but with a maximum of 29.2 MJ/h.	760 mm
Single burner gas cooktop with an output greater than 29.2 MJ/h.	Not possible

## Installation recommendations

- When deciding on the safety distance between the cooktop and rangehood, please note that a distance of 650 mm above electric cooktops may be preferable to give more working space under the rangehood.
- Account should also be taken of the height of the person who will be using the rangehood most often. They should have sufficient space to work comfortably at the cooktop, and be able to reach the rangehood controls with ease.
- If positioned too high, extraction will be inefficient.
- To achieve optimum vapour extraction, the rangehood must be positioned centrally over the cooktop, not to the side.
- The cooktop should be no wider than the rangehood and, if possible, it should be narrower, especially for safety distances greater than 750 mm.
- The installation area must be easily accessible. The rangehood should be easily accessible and easy to dismantle in the event that service is required. This should be taken into consideration when planning the position of cupboards, shelves, ceilings or features in the vicinity of the rangehood.

## Drilling diagram for wall mounting

- Please follow the directions given in the installation instructions supplied for drilling.

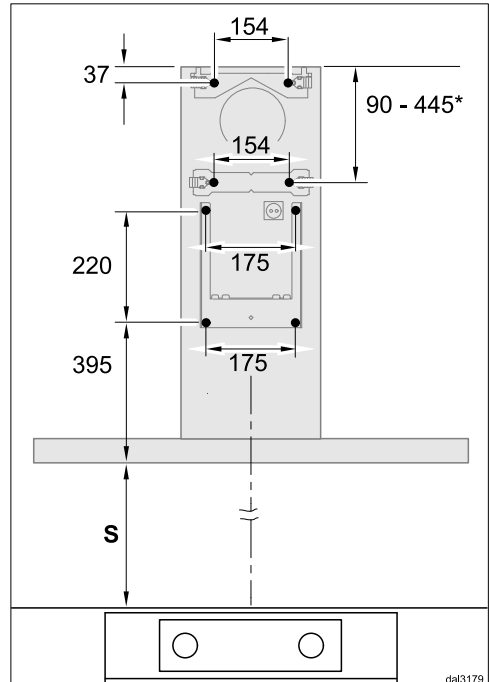

- For pre-installation of a back wall where the holes have to be pre-drilled, please refer to the drilling distances in the drawing above (screws  $\varnothing$  5 mm).

\*The dimension for the middle wall bracket is variable. It will depend on the position of the wall vent and the socket. It should be set as low as possible.

# Connection for air extraction

**⚠** Before installation, it is important to read the information given on the following pages as well as the “Appliance dimensions” and the “Warning and Safety instructions” at the beginning of this booklet. This is particularly crucial when using the rangehood at the same time as a heating appliance that relies on oxygen from the same room, which could result in the build-up of toxic fumes.

The rangehood should be installed according to local and national building regulations. Seek approval from the building inspector where necessary.

Only use smooth pipes or flexible hoses made from non-flammable materials for the extraction ducting.

To achieve the greatest possible air extraction with the lowest noise level, please note the following:

- The diameter of the exhaust ducting should not be less than 150 mm.
- If flat ducting is being used, the cross-sectional area must not be smaller than the cross-sectional area of the exhaust connection.
- The exhaust ducting should be as short and straight as possible.
- Only use wide radius bends.
- The exhaust ducting must not be kinked or compressed.
- Ensure that all connections are strong and airtight.

Remember that any constriction of the airflow will reduce extraction performance and increase operating noise.

- If the exhaust is ducted through an outside wall, a telescopic wall vent or a roof vent (available as an optional accessory) is recommended.

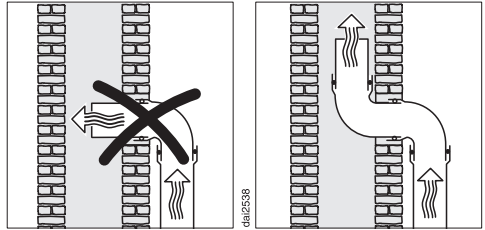

- If the exhaust air is to be ducted into a vent flue, the ducting must be directed in the flow direction of the flue.
- When ducting is horizontal, it must be laid to slope away at at least 1 cm per metre. This is to ensure that condensate cannot drain back into the rangehood.
- If the exhaust ducting is to run through rooms, ceiling space etc. where there may be great variations in temperature between the different areas, the problem of condensation will need to be addressed. The exhaust ducting will need to be suitably insulated.



## Condensate trap

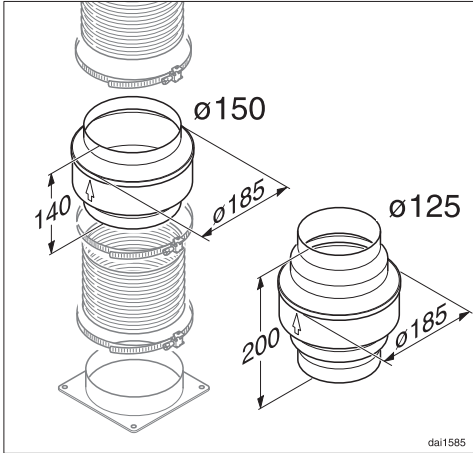

In addition to insulating the exhaust ducting, we recommend that a suitable condensate trap is also installed to collect and evaporate any condensate which may occur.

Condensate traps are available for 125 mm or 150 mm ducting.

- When installing a condensate trap, ensure that it is positioned vertically and, if possible, directly above the exhaust socket.

The arrow on the housing indicates the direction of airflow.

## Silencer

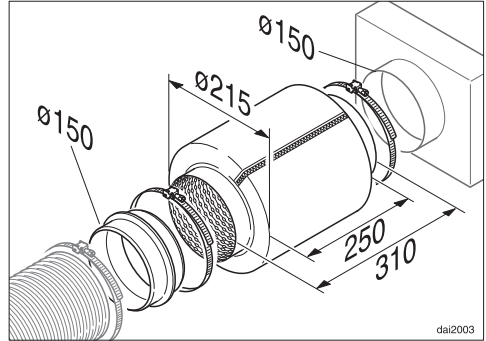

To achieve even further reductions in noise levels, a special silencer (optional accessory) can be fitted in the ducting system.

## Air extraction mode

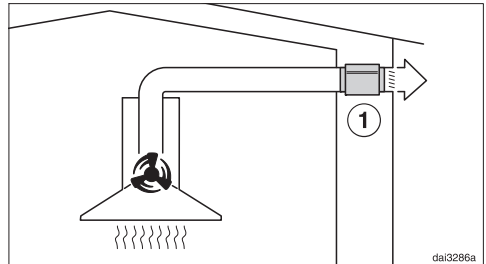

The silencer not only reduces noise from the motor outside the house, but also sounds from outside (e.g. traffic noise). For this reason, the silencer must be positioned as close as possible to the ducting exit ①.

# Connection for air extraction

---

## Recirculation mode

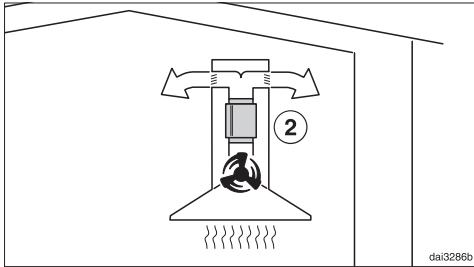

The silencer needs to be positioned between the exhaust connection and the directional unit ②. Ensure there is adequate space in the tower for fitting it.

All electrical work must be undertaken by a suitably qualified and competent person in strict accordance with current national and local safety and building code regulations. Installation, repairs and other work by unqualified persons could be dangerous, for which the manufacturer cannot be held liable. Ensure power is not supplied to the appliance until after installation or repair work has been carried out.

The rangehood must be connected to a suitably earthed socket (AC 230 V, 50 Hz).

For extra safety it is advisable to install a residual current device (RCD) with a trip current of 30 mA.

Connection of this appliance must be made via a suitable isolator switch which provides disconnection on all poles and which complies with national and local safety regulations. The isolator switch should be easily accessible after the appliance has been built in.

If the mains socket is not accessible after installation, an additional means of disconnection must be provided for all poles. There must be an all-pole contact gap of 3 mm in the switch (including switch, fuses and relays).

The connection data is given on the data plate (See "After sales service"). Ensure that this data matches the household mains supply.

## After sales service and warranty

---

In the event of a fault which you cannot remedy yourself, please contact Miele.

The contact details for Miele are given at the back of these instructions.

When contacting Miele, please quote the model and serial number of your appliance.

These can be found on the data plate.

### Position of the data plate

The data plate is visible after removing the grease filters.

### Warranty

AU, NZ:

The manufacturer's warranty for this appliance is 2 years.

For further information, please refer to your warranty booklet.

Other countries:

For information on the appliance warranty specific to your country please contact Miele. See the end of this booklet for contact details.

## Technical data

Fan motor	295 W
Cooktop lighting	
PUR 68 W	2 x 3 W
PUR 98 W	3 x 3 W
Total rated load	
PUR 68 W	301 W
PUR 98 W	304 W
Voltage, frequency	AC 230 V, 50 Hz
Fuse rating	10 A
Mains connection cable length	1.5 m
Weight	
PUR 68 W	21 kg
PUR 98 W	25 kg

### Optional accessory for recirculation mode

DUW 20 kit to convert from extraction mode to recirculation mode and charcoal filter DKF 12-1 or DKF 12-R (reactivatable).

### Note for test institutes

#### Note for comparative testing

Data quoted in the following data sheets was calculated in accordance with the current standards EN 61501 and EN 60704-3. The distance between the area being measured/stovetop and the underside of the rangehood is 600 mm and the voltage 230 V for test purposes. Testing is carried out without a non-return valve.



**Miele Australia Pty. Ltd.**

ACN 005 635 398  
ABN 96 005 635 398

**Miele Experience Centre and  
Head Office Melbourne:**

1 Gilbert Park Drive  
Knoxfield, VIC 3180

**Miele Experience Centre South Melbourne:**

206-210 Coventry Street  
South Melbourne, VIC 3205

**Miele Experience Centre and Office Sydney:**

3 Skyline Place  
Frenchs Forest, NSW 2086

**Miele Experience Centre and Office Brisbane:**

39 Harvey Street North  
Eagle Farm, QLD 4009

**Miele Experience Centre Gold Coast:**

131 Ferry Road  
Southport, QLD 4215

**Miele Experience Centre and Office Adelaide:**

83-85 Sir Donald Bradman Drive  
Hilton, SA 5033

**Miele Experience Centre and Office Perth:**

205-207 Stirling Highway  
Claremont, WA 6010



[www.miele.com.au](http://www.miele.com.au)

**Miele New Zealand Limited**

IRD 98 463 631

**Head Office:**

Level 2, 10 College Hill  
Freemans Bay, Auckland 1011

**Miele Experience Centre  
Auckland:**

8 College Hill  
Freemans Bay, Auckland 1011  
Telephone:  
0800 464 353 (0800 4 MIELE)  
[www.miele.co.nz](http://www.miele.co.nz)

**Miele Global Headquarters**

**Germany**

**Miele & Cie. KG**

Carl-Miele-Straße 29  
33332 Gütersloh  
Federal Republic of Germany

PUR 68 W  
PUR 98 W

en-AU, NZ

M.-Nr. 10 553 490 / 02