

Operating and installation instructions Rangehood



To prevent the risk of accidents or damage to the appliance, it is **essential** to read these instructions before it is installed and used for the first time.

Contents

Warning and Safety instructions	4
Caring for the environment	13
Guide to the appliance	14
Description of the functions	16
Operation	17
Switching the fan on.....	17
Selecting a power setting.....	17
Run-on time.....	17
Switching the fan off	17
Switching the cooktop lighting on/off	17
Power management	17
Switching Power management on/off	18
Safety switch-off	18
Energy saving tips	19
Cleaning and care	20
Housing	20
Important for appliances with lacquered casing	20
Grease filters	21
NoSmell active charcoal filter.....	23
Disposing of the charcoal filters	23
Changing a lamp	24
Service	25
Contact in case of fault	25
Position of the data plate	25
Warranty	25
Installation	26
Before installation.....	26
Protective foil.....	26
Installation materials.....	26
Appliance dimensions	28
Safety distance (S)	29
Installation recommendations	31
Drilling diagram for wall mounting.....	31
Connection for air extraction.....	32
Condensate trap.....	33
Silencer.....	33
Electrical connection	34

Technical data	35
Optional accessory for recirculation mode	35

Warning and Safety instructions

This rangehood complies with all relevant local and national safety requirements. However, inappropriate use can lead to personal injury and damage to property.

Read the operating and installation instructions carefully before using the rangehood. They contain important information on the safety, installation, use and maintenance of the appliance. This prevents both personal injury and damage to the rangehood.

In accordance with standard IEC 60335-1, Miele expressly and strongly advises that you read and follow the instructions in “Installation” and in the “Warning and Safety instructions”.

Miele cannot be held liable for injury or damage caused by non-compliance with these instructions.

Keep these instructions in a safe place and pass them on to any future owner.

Correct application

▶ This rangehood is designed for domestic use and for use in similar environments by guests in hotel or motel rooms, bed & breakfasts and other typical living quarters. This does not include common/shared facilities or commercial facilities within hotels, motels or bed & breakfasts.

▶ The appliance is not suitable for outdoor use.

▶ It must only be used to extract vapours and remove odours from cooking.

Any other usage is at the owner's risk. Miele cannot be held liable for damage resulting from incorrect or improper use or operation.

▶ The rangehood cannot be used to ventilate the installation room in recirculation mode above a gas cooktop. Please seek the advice of a qualified gas fitter for more information if necessary.

Warning and Safety instructions

▶ This appliance is not intended for use by persons (including children) with reduced physical, sensory or mental capabilities, or lack of experience and knowledge, unless they have been given supervision or instruction concerning its use by a person responsible for their safety, and are able to recognise the dangers of misuse.

Safety with children

▶ Young children must not be allowed to use the rangehood.

▶ Older children may only use the rangehood if its operation has been clearly explained to them and they are able to use it safely. They must be able to understand and recognise the possible dangers caused by incorrect operation.

▶ Cleaning work may only be carried out by older children under the supervision of an adult.

▶ Children should be supervised near the appliance. Ensure that they do not play with the appliance.

▶ The cooktop lighting is very intense.

Ensure, in particular, that babies/small children do not look directly at the light.

▶ Danger of suffocation! Whilst playing, children may become entangled in packaging material (such as plastic wrapping) or pull it over their head with the risk of suffocation. Keep packaging material away from children.

Warning and Safety instructions

Technical safety

- ▶ Unauthorised installation, maintenance and repairs (including removal of any cover) can cause considerable danger for the user. Installation, maintenance and repairs must only be carried out by a Miele authorised technician.
- ▶ A damaged appliance can be dangerous. Check it for visible signs of damage. Do not use a damaged appliance.
- ▶ The electrical safety of this appliance can only be guaranteed when continuity is complete between it and an effective earthing system. It is most important that this basic safety requirement is present and tested regularly and, where there is any doubt, the household wiring system should be inspected by a qualified electrician.
- ▶ Reliable and safe operation of this rangehood can only be assured if it has been connected to the mains electricity supply.
- ▶ The connection data (voltage and frequency) on the data plate of the rangehood must match the mains electricity supply in order to avoid the risk of damage to the rangehood.
Compare this before connecting the appliance to the mains electricity. If in doubt, consult a qualified electrician.
- ▶ Do not connect the appliance to the mains electricity supply by a multi-socket unit or an extension lead. Extension leads are a fire hazard and do not guarantee the required safety of the appliance.

Warning and Safety instructions

- ▶ For safety reasons, this appliance may only be used after it has been built in.
- ▶ This rangehood must not be installed and operated in mobile installations (e.g. on a ship).
- ▶ Tampering with electrical connections or components and mechanical parts is highly dangerous to the user and can cause operational faults.
Only open the housing as described in the instructions given in the installation sheet and in the “Cleaning and care” section of this booklet. Under no circumstances should any other parts of the housing be opened.
- ▶ The manufacturer's warranty will be invalidated if the appliance is not repaired by a Miele authorised service technician.
- ▶ Faulty components must only be replaced by genuine Miele spare parts. The manufacturer can only guarantee the safety of the appliance when Miele replacement parts are used.
- ▶ If the mains connection cable is damaged, it must only be replaced by a Miele authorised service technician or suitably qualified and competent electrician in order to avoid a hazard.
- ▶ During installation, maintenance and repair work, the appliance must be disconnected from the mains electricity supply. It is only completely isolated from the electricity supply when:
 - the mains circuit breaker is switched off, or
 - it is switched off at the wall socket and the plug is withdrawn from the socket. Do not pull the mains connection cable but the mains plug to disconnect your appliance from the mains electricity supply.

Warning and Safety instructions

Using at the same time as other heating appliances that depend on the air from the room

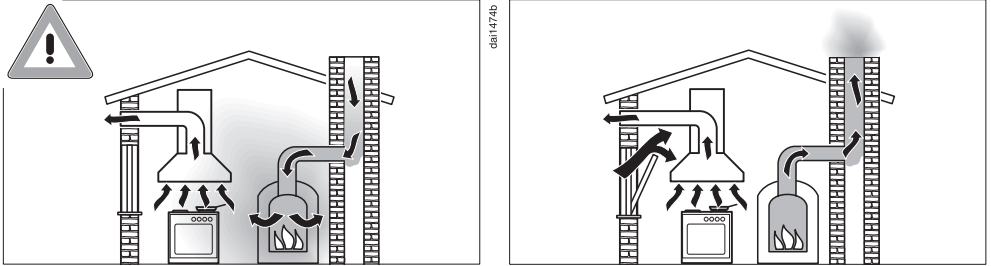

Danger of toxic fumes!

Great care should be taken when using the rangehood in the same room or the same area of the house as another heating appliance that depends on the air from the room.

Such heating appliances draw in air from the room and duct exhaust gases out through a chimney or extraction ducting. They include gas, oil, wood and coal-fired boilers and heaters, continuous flow or other water heaters, gas cooktops and ovens.

The rangehood draws in air from the kitchen and from neighbouring rooms. This applies to the following modes of operation:

- extraction mode
- recirculation mode with a recirculation box installed outside the room.

If there is insufficient air, an underpressure will occur. The heating appliance may be starved of oxygen. This impairs combustion. Harmful gases could be drawn from the chimney or extraction ducting back into the room.

This could have potentially fatal consequences. Risk of death!

Warning and Safety instructions

In order to ensure safe operation and to prevent gases given off by a heating appliance from being drawn back into the room, when the rangehood and the heater are both operated simultaneously, an underpressure in the room of 0.04 mbar (4 Pa) is the maximum permissible.

Sufficient ventilation can be maintained by air inlets which cannot be blocked, e.g. in windows, doors and outside wall vents. The diameter of the inlet openings must enable sufficient ventilation. A ventilation brick alone is not generally sufficient to ensure safe ventilation.

The overall ventilation condition of the dwelling must be taken into account. If in any doubt, the advice of a competent builder or, for gas, a qualified gas fitter (registered with an official gas safety body in accordance with national safety regulations) must be sought.

If the rangehood is being operated in recirculation mode, whereby the air is redirected into the room in which it is installed, the above restrictions do not apply.

Warning and Safety instructions

Correct use

▶ Open flames are a fire hazard!

Never use an open flame under the rangehood. To avoid the danger of fire, do not flambé or grill over an open flame. When switched on, the rangehood could draw flames into the filter. Kitchen grease deposits could ignite.

▶ The rangehood can become damaged when exposed to excessive heat.

- When using the rangehood over a gas cooktop, ensure that any burners in use are always covered by a pan. Switch the cooking zone off when a pan is removed, even for a short time.
- Select a pan which is suitable for the size of the burner.
- Regulate the flame so that it does not burn up the sides of the pan.
- Avoid overheating the pan (e.g. when cooking with a wok).

▶ Always switch the rangehood on when a cooking zone is in use, otherwise condensation may collect in the rangehood, which could cause corrosion.

▶ Overheated oil and fat can ignite, causing fire damage to the rangehood.

When cooking with oil or fat, chip pans and deep fat fryers etc., do not leave the pans unattended. Similarly, never leave an open grill unattended when grilling.

Warning and Safety instructions

- ▶ Do not use the rangehood without the filters in place. This way you will avoid the risk of grease and dirt getting into the appliance and hindering its smooth operation.
- ▶ The rangehood can get very hot during cooking due to heat rising from the cooktop.
Do not touch the housing or the grease filters until the rangehood has cooled down.

Correct installation

- ▶ Refer to the cooktop manufacturer's instructions as to whether a rangehood may be operated above the cooktop.
- ▶ Safety regulations prohibit the fitting of a rangehood over solid fuel stoves.
- ▶ An insufficient safety distance between the cooktop and the rangehood can result in damage to the rangehood.
The minimum safety distances between the top of the cooktop and the bottom of the rangehood given in the “Installation” section of this booklet must be observed, unless the cooktop manufacturer states that a greater safety distance is required.
If more than one cooking appliance is fitted beneath the rangehood, and they have different minimum safety distances to the rangehood, select the greater distance.
- ▶ The distances given in “Installation” must be observed when fitting the rangehood.
- ▶ Metal parts can have sharp edges which may cause injury.
Wear gloves to protect your hands from being cut.
- ▶ All ducting, pipework and fittings must be of non-flammable material and comply with all relevant national and local building regulations.

Warning and Safety instructions

- ▶ The appliance must not be connected to a chimney or vent flue which is in current use for exhausting fumes from appliances burning gas or other fuels. Neither should it be connected to ducting which ventilates rooms with fireplaces.
- ▶ If exhaust air is to be extracted into a chimney or ventilation duct no longer used for other purposes, seek professional advice.

Cleaning and care

- ▶ There is a risk of fire if cleaning is not carried out as described in these operating instructions.
- ▶ Do not use a steam cleaning appliance to clean this appliance. The steam could reach electrical components and cause a short circuit.
- ▶ In areas which may be subject to infestation by cockroaches or other vermin, pay particular attention to keeping the machine and its surroundings in a clean condition at all times. Any damage which may be caused by cockroaches or other vermin will not be covered by the machine warranty.

Accessories

- ▶ Use only genuine original Miele spare parts. If spare parts or accessories from other manufacturers are used, the warranty will be invalidated, and Miele cannot accept liability.

Disposal of the packing material

The transport and protective packaging has been selected from materials which are environmentally friendly for disposal, and can normally be recycled.

Recycling the packaging reduces the use of raw materials in the manufacturing process and also reduces the amount of waste in landfill sites. Ensure that any plastic wrappings, bags etc. are disposed of safely and kept out of the reach of babies and young children. Danger of suffocation.

Disposing of your old appliance

Electrical and electronic appliances often contain valuable materials. They also contain specific materials, compounds and components, which were essential for their correct function and safety. These could be hazardous to human health and to the environment if disposed of with your domestic waste or if handled incorrectly. Please do not, therefore, dispose of your old appliance with your household waste.



Please dispose of it at your local community waste collection / recycling centre for electrical and electronic appliances. You are also responsible for deleting any personal data that may be stored on the appliance prior to disposal. Please ensure that your old appliance poses no risk to children while being stored prior to disposal.

Guide to the appliance

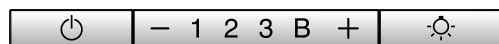
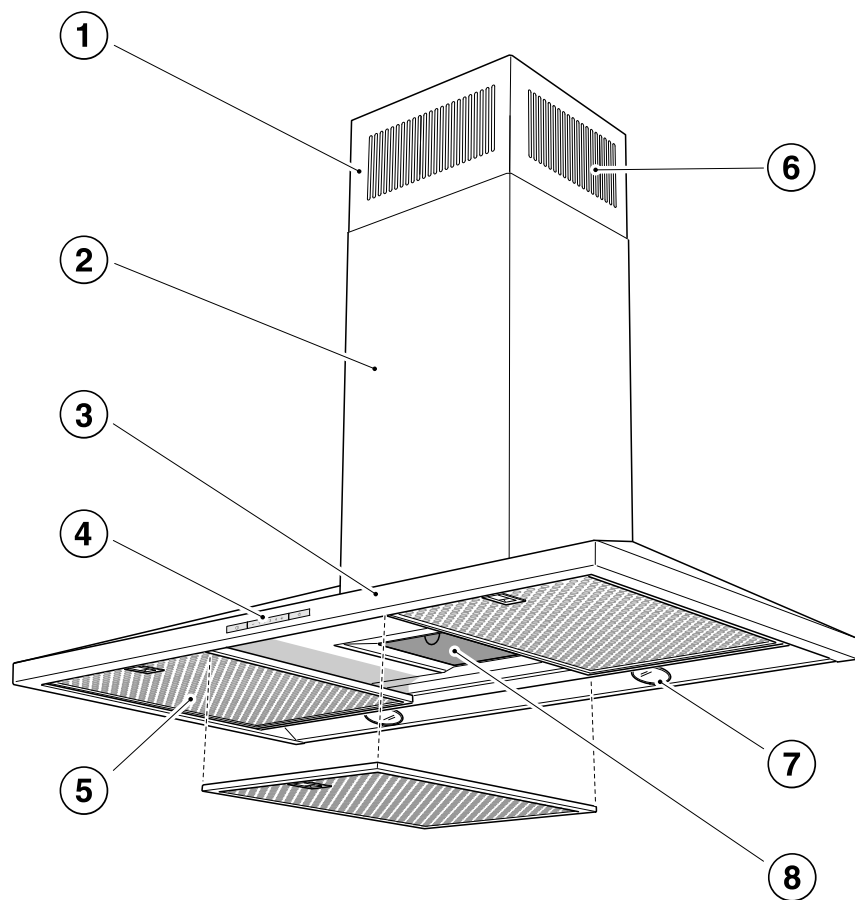

9

10

11

- ① Telescopic extension piece
- ② Tower
- ③ Canopy
- ④ Controls
- ⑤ Grease filters
- ⑥ Recirculation grilles
(only for recirculation mode)
- ⑦ Cooktop lighting
- ⑧ NoSmell active charcoal filter
(special accessory for recirculation mode)
- ⑨ On/Off touch control for the fan
- ⑩ Touch controls to select the fan power setting
- ⑪ On/Off touch control for the cooktop lighting

Description of the functions

Depending on the model of the rangehood, the following options are available:

Air extraction mode

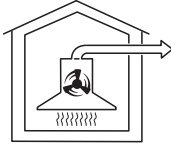

da100494a

The air is drawn in and cleaned by the grease filters and directed outside.

Non-return flap

A non-return flap fitted in the exhaust air system ensures that when the rangehood is not in operation the duct is closed and no exchange of room air and outside air can take place.

The flap is closed when the rangehood is switched off.

When the rangehood is switched on, the non-return flap opens for the cooking vapours to be blown directly outside.

If the on-site exhaust air system does not have a non-return flap, one is supplied with the rangehood. It must be fitted in the exhaust socket on the motor unit.

Recirculation mode

(available as an optional extra with a conversion kit and charcoal filter: see “Technical Data”)



da100494b

The air is drawn in and cleaned first by the grease filters and then by a charcoal filter. The cleaned air is then recirculated back into the kitchen.

Switching the fan on

Switch the fan on as soon as you start cooking. This is to ensure that vapours are captured right from the start.

- Press the On/Off touch control .

The fan will switch on at setting **2**. The  symbol and **2** will light up in the power setting display.

Selecting a power setting

For light to heavy cooking vapours and odours, select from power settings **1** to **3**.

For short periods of cooking food with intensive vapours and a strong aroma, e.g. when searing meat, select Booster setting **B**.

- Select the power level you want by pressing the **–** or **+** controls.

Reducing power down from the Booster setting

If Power management is activated (default setting), the fan automatically switches back to level **3** after 5 minutes.

Run-on time

- It is advisable to run the fan for a few minutes after cooking has finished.

This helps to remove any lingering vapours and odours from the air.

It also reduces the risk of residues accumulating in the rangehood and any resultant odours.

Switching the fan off

- Press the On/Off touch control  to switch the fan off.

The  symbol will go out.

Switching the cooktop lighting on/off

The cooktop lighting can be switched on and off independently of the fan.

- To do so press the lighting control .

The  symbol will light up when the cooktop lighting is switched on.

Power management

The rangehood is fitted with a power management system. The power management system is designed to help save energy. It ensures that the fan power level is reduced automatically and that the lighting is switched off.

- If the Booster setting has been selected, the fan will automatically switch to setting 3 after 5 minutes.
- From fan power levels 3, 2 and 1, the power will be reduced by one level after 2 hours and then in 30-minute stages until the fan finally switches off.
- The cooktop lighting will switch off automatically after 12 hours.



Operation

Switching Power management on/off

You can deactivate the Power management.

Keep in mind that this may increase energy consumption.

- To set this option, both the fan and the cooktop lighting must be switched off.
- Press the **–** and **+** controls at the same time for approx. 10 seconds, until **1** lights up.
- Then press in turn:

- the lighting control ,
- then the **–** touch control, and
- the lighting control  again.

If Power management is switched on, the **1** and **B** indicators light up constantly.

When it is switched off, the **1** and **B** indicators flash.

- Press **–** to switch Power management off.

The **1** and **B** indicators will flash.

- To switch it on, press **+**.

The **1** and **B** indicators will light up constantly.



- Confirm your choice with the On/Off control .

All the indicator lights will go out.

If you don't confirm your selection within 4 minutes, the rangehood will automatically revert to the previous setting.

Safety switch-off

If Power management has been deactivated, the rangehood will switch itself off automatically after 12 hours if it has been left on (fan and cooktop lighting).

- To switch it back on press the On/Off  control or the lighting control .

This rangehood operates very efficiently and economically. The following will help you to save even more energy when using it:

- Ensure that there is sufficient ventilation in the kitchen when cooking. In extraction mode, if there is insufficient air flow the rangehood cannot operate efficiently and this causes increased operating noise levels.
- Always cook with the lowest possible setting. This produces fewer cooking vapours, so you can use a lower rangehood power level and therefore benefit from reduced energy consumption.
- Check the power level selected on the rangehood. A lower power level is generally sufficient for the majority of cooking. Only use the Booster setting when necessary.
- When a large volume of cooking vapours are being produced, switch to a high power level in good time. This is more efficient than operating the rangehood for longer to try to capture cooking vapours which have already been distributed throughout the kitchen.
- Make sure that you switch the rangehood off after use.
- Clean or change the filters at regular intervals. Heavily soiled filters reduce performance, increase the risk of fire and are unhygienic.

Cleaning and care

 Before carrying out any maintenance or cleaning, the rangehood must be disconnected from the electricity supply (see “Warning and Safety instructions”).

Housing

General information

Unsuitable cleaning agents can damage the surfaces and control elements.

Do not use any cleaning agents containing soda, acid, chloride, or solvent.

Do not use any abrasive cleaning agents, e.g. powder cleaners or cream cleaners and abrasive sponges, or pot scourers or sponges which have been used previously with abrasive cleaning agents.

 Moisture in the rangehood can cause damage.
Make sure that water does not get into the rangehood.

- Clean all surfaces and control elements using a small amount of warm water and dishwashing liquid. Apply with a soft sponge.
- After cleaning, wipe the surfaces dry using a soft cloth.

Important information for appliances with stainless steel surfaces

This information does not apply to the control elements.

Stainless steel surfaces can be cleaned with a non-abrasive cleaning agent designed specifically for use on stainless steel.

To prevent the surfaces from quickly becoming dirty again, we recommend treating them with a stainless steel care product (available from Miele).

Important for appliances with lacquered casing

(special order finish)

Minor scratches on the surface are inevitable when cleaning the casing; they may be visible depending on the lighting in the kitchen.

Important information for the control elements

If soiling is not removed promptly, it could cause the control elements to alter or discolor.

Remove any soiling immediately.

The surface of the control elements can be damaged if they are cleaned using stainless steel cleaning agents. Do not use stainless steel cleaning agents on the control elements.

Grease filters

⚠ Fire hazard!

Oversaturated grease filters are a fire hazard.

Clean the grease filters at regular intervals.

The re-usable metal grease filters in the appliance remove solid particles (grease, dust, etc.) from the kitchen vapours, preventing soiling of the rangehood.

The grease filters must be cleaned at regular intervals.

Heavily soiled grease filters hinder air extraction and will lead to increased levels of soiling in the rangehood and in the kitchen.

Grease filter cleaning intervals

Accumulated grease solidifies over a longer period of time and makes cleaning more difficult. The grease filters should therefore be cleaned every 3 to 4 weeks.

Removing the grease filter

⚠ When handling the grease filter, be careful not to drop it.

This can result in damage to the filter and the cooktop below.

Make sure you hold the filter securely at all times when handling it.

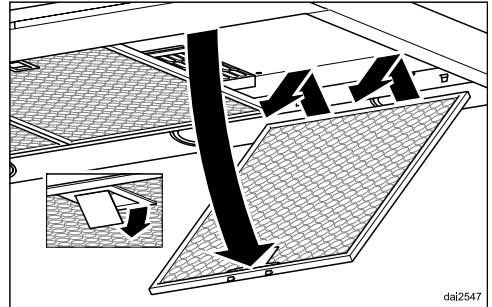

- To take out the grease filter, release the locking clip on the filter, lower the filter approx. 45°, unhook it at the back and remove it.

Cleaning and care

Cleaning the grease filters by hand

- Clean the filters with a soft nylon brush in a mild solution of hot water and a small amount of washing-up liquid. Do not use undiluted washing up liquid.

Unsuitable cleaning agents

Unsuitable cleaning agents can cause damage to the surface of the filters if used regularly.

Do not use:

- cleaning agents containing descaling agents,
- powder cleaners or cream cleaners,
- aggressive all-purpose cleaning agents or spray cleaners for grease,
- oven sprays.

Cleaning the grease filters in the dishwasher

- Place the grease filters upright or slightly inclined in the lower basket. Ensure the spray arm is not obstructed.
- Use a standard household dishwasher detergent.
- Select a dishwasher programme with a wash temperature between 50 °C and 65 °C.

Depending on the detergent used, cleaning the filters in the dishwasher may cause the inside filter surfaces to become discoloured. This will not affect the functioning of the grease filters in any way.

After cleaning

- After cleaning, leave the filters to dry on an absorbent surface before refitting them.
- When removing the filters for cleaning, also clean off any residues of oil or fat from the now accessible housing to prevent the risk of these catching fire.
- Replace the grease filters, making sure that the locking clips are facing down towards the cooktop.

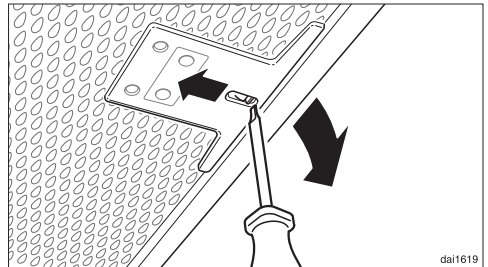

- If a grease filter is inadvertently refitted upside down, insert a small screwdriver blade into the slit to disengage the clip.

NoSmell active charcoal filter

With recirculation mode, a charcoal filter must be fitted in addition to the grease filters. The charcoal filter is designed to absorb cooking odours.

The charcoal filter is fitted in the canopy above the grease filters.

Charcoal filters are available to order via the Miele online shop (see the end of this booklet for contact details) or directly from Miele. The part number of the charcoal filter required is listed under "Technical data".

Fitting/replacing the charcoal filter

- Remove the grease filters before fitting or replacing the charcoal filter.
- Take the charcoal filter out of its packaging.

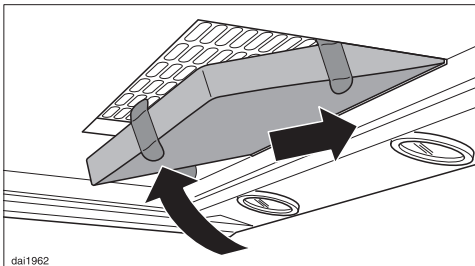

- Insert the charcoal filter into the back of the charcoal filter frame, then push up into the frame at the front.
- Refit the grease filters.

When to change the NoSmell active charcoal filter

- Replace the charcoal filter when it no longer absorbs kitchen odours effectively.
It should be replaced at least every 6 months.

Disposing of the charcoal filters

- Used charcoal filters can be disposed of with the normal household waste.

Cleaning and care

Changing a lamp

The lamps should be replaced with the following:

Manufacturer	EGLO
Lamp type	GU10
Specification.....	12981
Wattage	3 W
ILCOS D Code.....	DR-3-H-GU10-50/56

These lamps are available from Miele or from specialist retailers.

- Switch off the fan and the lighting.



Note that the lamps become hot when in use.

They can cause burns even after being switched off for some time.

Allow the lamps to cool down for a few minutes before changing them.

- Disconnect the rangehood from the mains electrical supply before replacing the lamps (see “Warning and Safety instructions”).
- Remove the grease filters.

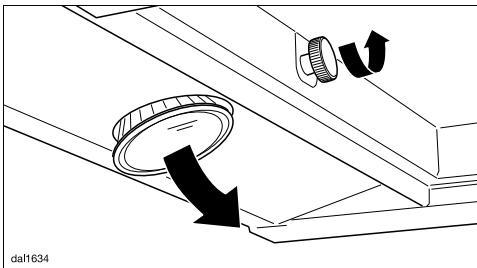

- Turn the nut anti-clockwise as far as it will go. The lamp will then drop down towards you.

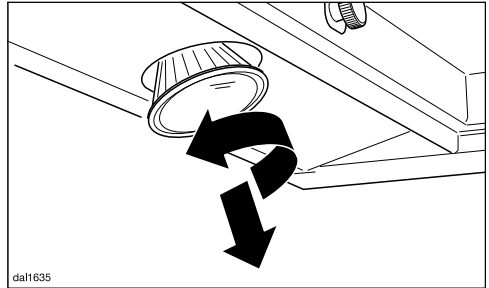

- Turn the lamp anti-clockwise and pull it out.
- Screw the new lamp into the socket and push it upwards. Please follow the manufacturer's safety instructions.

Contact in case of fault

In the event of any faults which you cannot remedy yourself, please contact Miele.

Contact information for Miele can be found at the end of this booklet.

Please quote the model and serial number of your appliance when contacting Miele. This information can be found on the data plate.

Position of the data plate

The data plate is visible after removing the grease filters.

Warranty

The manufacturer's warranty for this appliance is 2 years.

For further information, please refer to your warranty booklet.

Installation

Before installation

 Before installation, it is important to read the information given on the following pages as well as the “Warning and Safety instructions” at the beginning of this booklet.

Protective foil

The housing components have protective foil around them to prevent them from transport damage.

- Please remove this foil before fitting the housing components. It can be peeled off easily.

Installation materials

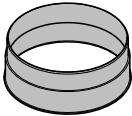

1 exhaust connection
for exhaust ducting \varnothing 150 mm.

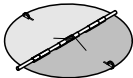

1 non-return flap
for fitting into the exhaust connection on the motor unit (not needed for recirculation mode). Depending on model, the non-return flap may already be fitted.

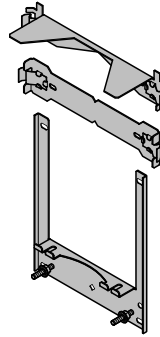

3 wall brackets
for securing the rangehood to the wall.

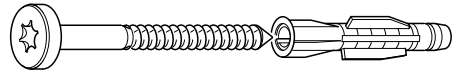

8 screws, 5 x 60 mm and
8 dowels, 8 x 50 mm
for securing the rangehood to the wall.

 The screws and wall plugs are designed for use in solid walls only. For other types of wall construction, alternative fixings are required. Make sure the wall is able to take the weight of the rangehood.



2 M6 locknuts
for securing the appliance.



2 screws, 3.9 x 7.5 mm
for securing the chimney.

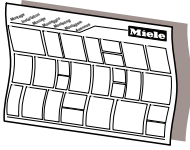

dina3mie

Installation plan

See the installation plan for details on the individual steps involved in the installation of this appliance.

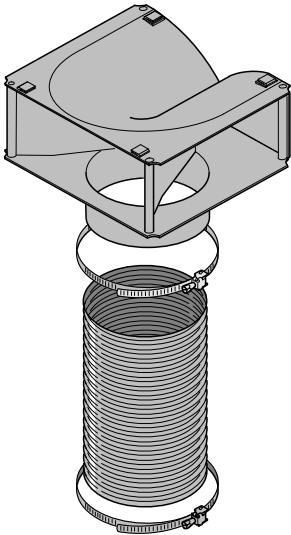

DJW20

Conversion kit for recirculation mode

The conversion kit contains an exhaust grille, hose, and hose clips (not supplied, but available as an optional accessory. See “Technical data”).

Installation

Appliance dimensions

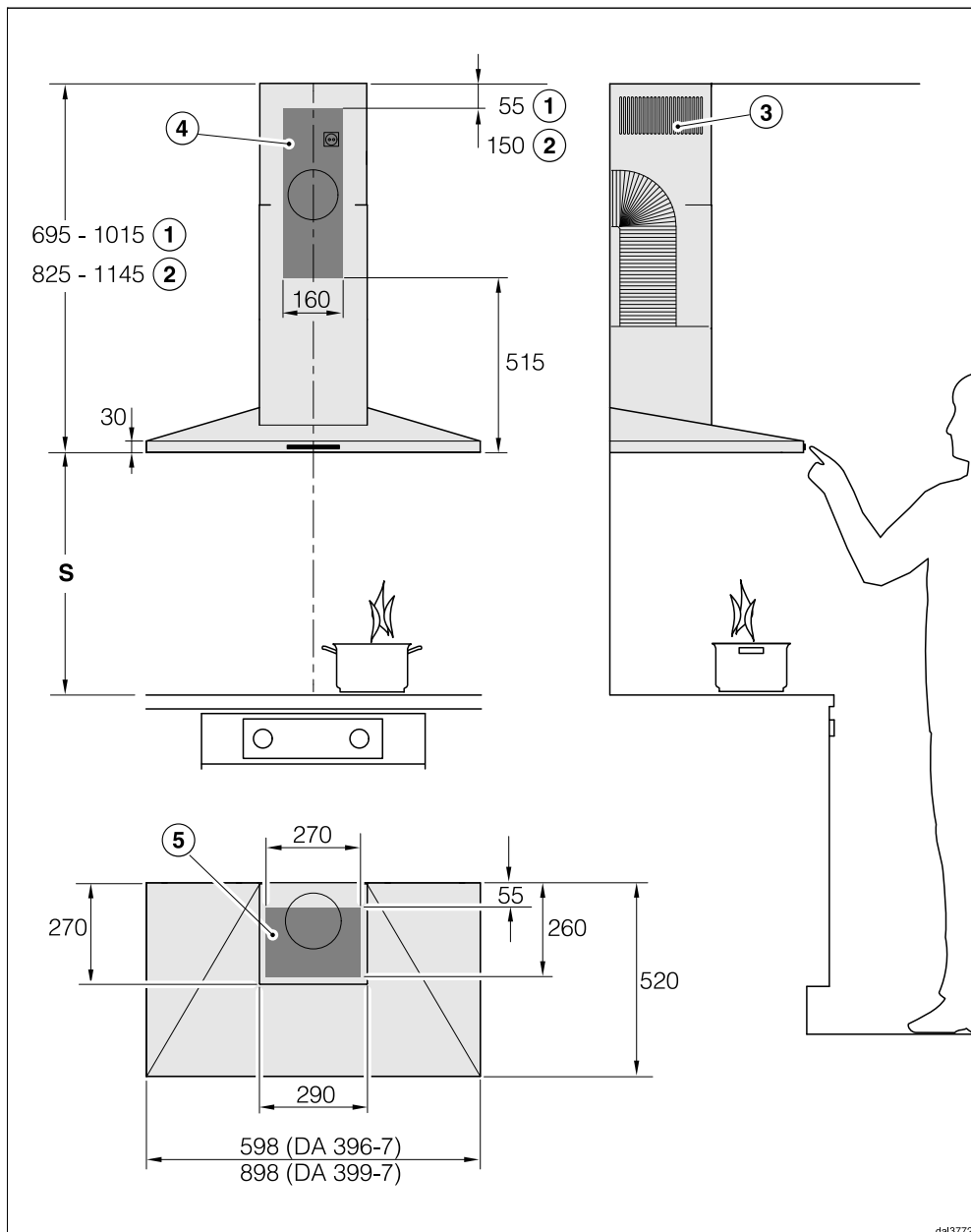

dal3772

The drawing is not to scale.

- ① Extraction
- ② Recirculation
- ③ Ventilation grille positioned at the top for recirculation
- ④ ⑤ (only ④ is required for recirculation mode rangehoods): The shaded area represents the wall or ceiling area for the vent cut-out and for fitting the connection socket. Recirculation mode rangehoods only require an electrical connection socket.

Connection for air extraction \varnothing 150 mm, or \varnothing 125 mm with reducing collar.

Safety distance (S)

The minimum distances between the cooking surface of a cooktop (pan support(s) for gas models) and the bottom of the rangehood are as follows, unless a greater distance is specified by the manufacturer of your cooking appliance. See also “Warning and Safety instructions”.

Installation

Cooking appliance	Minimum distance S
Electric cooktop	600 mm (AU, NZ) 450 mm (HK, MY, SG, TH, TW)
Electric grill, deep fat fryer (electric)	650 mm
Multi-burner gas cooktop with maximum 45.4 MJ/h total output, with no burner having a greater output than 16.2 MJ/h.	650 mm
Multi-burner gas cooktop with total output greater than 45.4 MJ/h, but with a maximum of 77.8 MJ/h, with no burner having a greater output than 17.3 MJ/h.	760 mm
Multi-burner gas cooktop with total output greater than 77.8 MJ/h, with a single burner having a greater output than 17.3 MJ/h.	Not possible
Single burner gas cooktop with a maximum output of 21.6 MJ/h.	650 mm
Single burner gas cooktop with an output greater than 21.6 MJ/h, but with a maximum of 29.2 MJ/h.	760 mm
Single burner gas cooktop with an output greater than 29.2 MJ/h.	Not possible

Installation recommendations

- When deciding on the safety distance between the cooktop and rangehood, please note that a distance of 650 mm above electric cooktops may be preferable to give more working space under the rangehood.
- Account should also be taken of the height of the person who will be using the rangehood most often. They should have sufficient space to work comfortably at the cooktop, and be able to reach the rangehood controls with ease.
- If positioned too high, extraction will be inefficient.
- To achieve optimum vapour extraction, the rangehood must be positioned centrally over the cooktop, not to the side.
- The cooktop should be no wider than the rangehood and, if possible, it should be narrower, especially for safety distances greater than 750 mm.
- The installation area must be easily accessible. The rangehood should be easily accessible and easy to dismantle in the event that service is required. This should be taken into consideration when planning the position of cupboards, shelves, ceilings or features in the vicinity of the rangehood.

Drilling diagram for wall mounting

- Please follow the directions given in the installation instructions supplied for drilling.

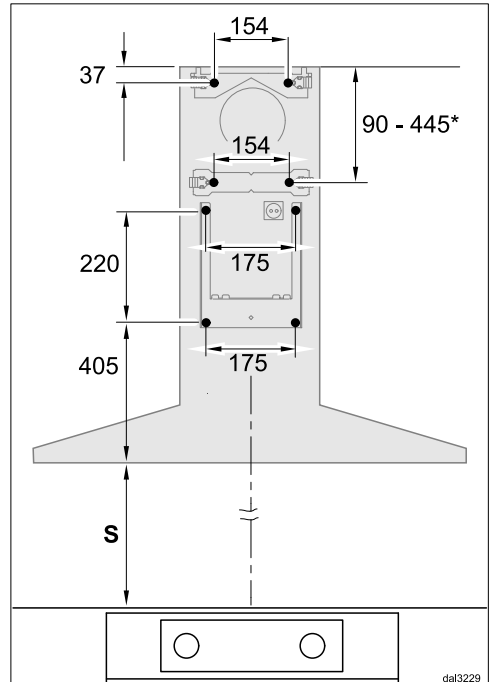

- For pre-installation of a back wall where the holes have to be pre-drilled, please refer to the drilling distances in the drawing above (screws \varnothing 5 mm).

*The dimension for the middle wall bracket is variable. It will depend on the position of the wall vent and the socket. It should be set as low as possible.

Installation

Connection for air extraction

 Before installation, it is important to read the information given on the following pages as well as the “Appliance dimensions” and the “Warning and Safety instructions” at the beginning of this booklet. This is particularly crucial when using the rangehood at the same time as a heating appliance that relies on oxygen from the same room, which could result in the build-up of toxic fumes.

The rangehood should be installed according to local and national building regulations. Seek approval from the building inspector where necessary.

Only use smooth pipes or flexible ducting made from approved non-flammable materials for exhaust ducting.

When using an external motor, make sure that the exhaust ducting is sufficiently rigid. The external motor can cause an underpressure which can result in the exhaust ducting distorting.

To achieve the greatest possible air extraction with the lowest noise level, please note the following:

- The diameter of the exhaust ducting should not be less than 150 mm.
- If flat ducting is being used, the cross-sectional area must not be smaller than the cross-sectional area of the exhaust connection.

- The exhaust ducting should be as short and straight as possible.
- Only use wide radius bends.
- The exhaust ducting must not be kinked or compressed.
- Ensure that all connections are strong and airtight.

Remember that any constriction of the airflow will reduce extraction performance and increase operating noise.

- If the exhaust is ducted through an outside wall, a telescopic wall vent or a roof vent (available as an optional accessory) is recommended.

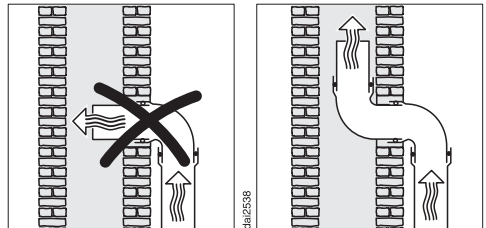

- If the exhaust air is to be ducted into a vent flue, the ducting must be directed in the flow direction of the flue.
- Where ducting is horizontal, it must be laid to slope away at at least 1 cm per metre. This is to ensure that condensate cannot drain back into the rangehood.
- If the exhaust ducting is to run through rooms, ceiling space etc. there may be great variations in temperature between the different areas. The problem of condensation

will need to be addressed. The exhaust ducting will need to be suitably insulated.

Condensate trap

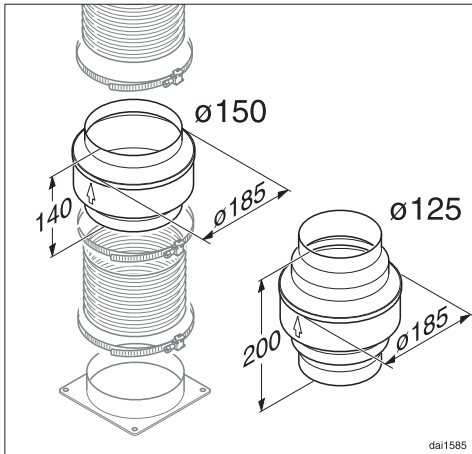

In addition to insulating the exhaust ducting, we recommend that a suitable condensate trap is also installed to collect and evaporate any condensate which may occur.

Condensate traps are available for 125 mm or 150 mm ducting.

- When installing a condensate trap, ensure that it is positioned vertically and, if possible, directly above the exhaust socket. The arrow on the housing indicates the direction of airflow.

Silencer

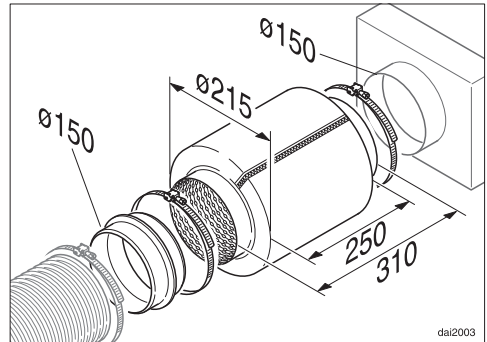

To achieve even further reductions in noise levels, a special silencer (optional accessory) can be fitted in the ducting system.

Air extraction mode

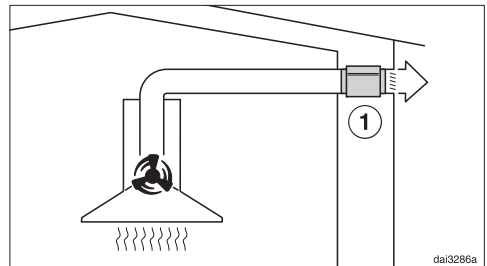

The silencer not only reduces noise from the motor outside the house, but also sounds from outside (e.g. traffic noise). For this reason, the silencer must be positioned as close as possible to the ducting exit ①.

Installation

Recirculation mode

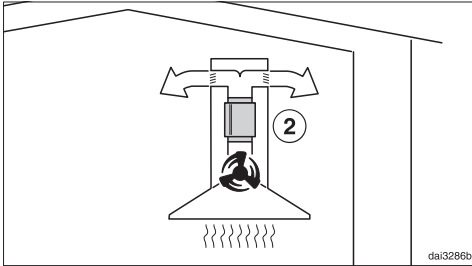

The silencer needs to be positioned between the exhaust connection and the directional unit ②. Ensure there is adequate space in the tower for fitting it.

Electrical connection

The rangehood must only be connected to a properly installed AC 230 V ~ 50 Hz earthed socket.

The electrical installation must be in compliance with current local and national safety regulations.

For extra safety, it is advisable to protect the appliance with a suitable residual current device (RCD) with a trip current of 30 mA.

Connection via a socket is recommended as it facilitates customer service (according to VDE 0701). The socket should be easily accessible after the appliance has been installed.

If the socket is no longer accessible after installation, an additional means of disconnection must be provided for all poles. Suitable means of disconnection include switches with an all-pole contact gap of at least 3 mm.

These include isolator switches, fuses and relays (EN 60335).

The relevant connection data can be found on the data plate (see "Service"). Ensure that this data matches the voltage and frequency of your household mains supply.

Technical data

Fan motor	120 W
Cooktop lighting	2 x 3 W
Total rated load	126 W
Voltage, frequency	AC 230 V, 50 Hz
Fuse rating	10 A
Mains connection cable length	1.5 m
Weight	
DA 396-7	21 kg
DA 399-7	26 kg

Optional accessory for recirculation mode

DUW 20 kit to convert from extraction mode to recirculation mode and charcoal filter DKF 12-1 or DKF 12-R (reactivatable).

**Miele Australia Pty. Ltd.**

ACN 005 635 398
ABN 96 005 635 398

Miele Experience Centre and
Head Office Melbourne:
1 Gilbert Park Drive
Knoxfield, VIC 3180

1300 464 353 (1300 4 MIELE)

www.miele.com.au

Miele (Hong Kong) Limited

41/F - 4101, Manhattan Place
23 Wang Tai Road
Kowloon Bay
Hong Kong
Tel.: (852) 2610 1025
Fax: (852) 3579 1404
E-mail: customerservices@miele.com.hk
Website: www.miele.hk

Singapore

Miele Pte. Ltd.
163 Penang Road
04 - 03 Winsland House II
Singapore 238463
Tel.: +65-67351191
Fax: +65-67351161
E-mail: info@miele.com.sg
Internet: www.miele.sg

Miele Global Headquarters Germany

Miele & Cie. KG Carl-Miele-Straße 29, 33332 Gütersloh, Federal Republic of Germany

Miele New Zealand Limited

IRD 98 463 631

Head Office:

Level 2, 10 College Hill
Freemans Bay, Auckland 1011

0800 464 353 (0800 4 MIELE)

www.miele.co.nz

Malaysia

Miele Sdn Bhd
Suite 12-2, Level 12
Menara Sapura Kencana Petroleum
Solaris Dutamas No. 1, Jalan Dutamas 1
50480 Kuala Lumpur, Malaysia
Phone: +603-6209-0288
Fax: +603-6205-3768

Thailand

BHIRAJ TOWER at EmQuartier
43rd Floor Unit 4301-4303
689 Sukhumvit Road
North Klongton Sub-District
Vadhana District
Bangkok 10110, Thailand

DA 396-7, DA 399-7

en-AU, NZ

M.-Nr. 11 468 970 / 01