

Operating and installation instructions

Rangehood

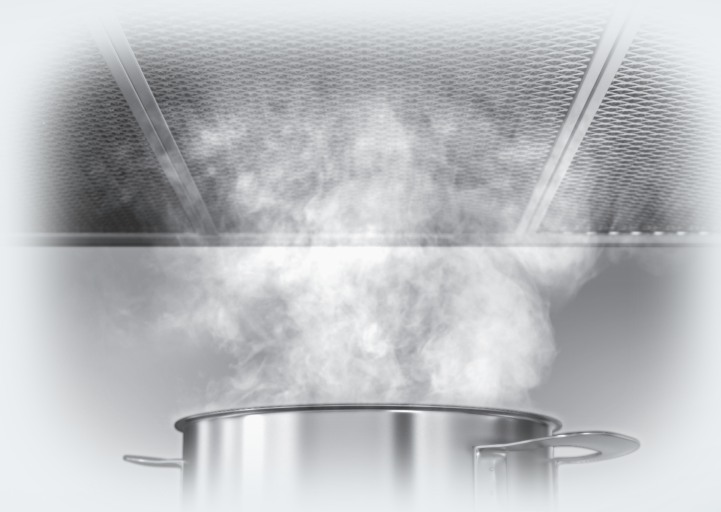

To prevent the risk of accidents or damage to the appliance, it is **essential** to read these instructions before it is installed and used for the first time.

Contents

Warning and Safety instructions	4
Caring for the environment	13
Guide to the appliance	14
Description of the functions	16
Before using for the first time	17
Selecting extraction mode or recirculation mode.....	17
Setting up Miele@home	17
Connecting via the App.....	18
Connecting via WPS	19
Signing out of Wi-Fi (reset to factory settings).....	20
Setting up Con@ctivity	21
Con@ctivity via the home Wi-Fi network (Con@ctivity 3.0).....	22
Con@ctivity via a direct Wi-Fi connection (Con@ctivity 3.0).....	22
Con@ctivity with radio frequency connection (Con@ctivity 2.0)	23
Operation (automatic mode)	27
Cooking with Con@ctivity (automatic mode)	27
Leaving automatic mode temporarily	29
Returning to automatic mode.....	29
Operation (manual mode)	30
Cooking without Con@ctivity (manual mode)	30
Switching the fan on.....	30
Selecting a power setting.....	30
Selecting the run-on time	30
Switching the fan off	30
Dimming/switching the cooktop lighting on/off	31
Power management	31
Safety switch-off	32
Operation (automatic and manual modes)	33
Operating hours counter	33
Altering the grease filter operating hours counter	33
Altering or deactivating the charcoal filter operating hours counter	34
Reading the filter operating hours counter.....	34
Energy saving tips	35
Cleaning and care	36
Housing	36
Grease filters	37

NoSmell active charcoal filter.....	39
Resetting the charcoal filter operating hours counter	40
Disposing of the charcoal filter.....	40
Reactivatable charcoal filter	40
Installation.....	41
Before installation.....	41
Protective foil.....	41
Installation instructions.....	41
Dismantling.....	41
Assembly parts.....	42
Appliance dimensions	44
Safety distance (S)	45
Installation recommendations	47
Drilling diagram for wall mounting.....	47
Connection for air extraction	48
Condensate trap.....	49
Silencer.....	49
Electrical connection	51
After sales service and warranty	52
Position of the data plate	52
Warranty	52
Technical data.....	53
Optional accessory for recirculation mode	53

Warning and Safety instructions

This appliance complies with all relevant local and national safety requirements. Inappropriate use can, however, lead to personal injury and damage to property.

To avoid the risk of accidents and damage to the appliance, please read these instructions carefully before using it for the first time. They contain important notes on the safety, installation, use and maintenance of the appliance. Miele cannot be held liable for non-compliance with these instructions.

Keep these instructions in a safe place and ensure that all users are familiar with the contents. Pass them on to any future owner of the appliance.

Correct application

- ▶ This rangehood is designed for domestic use and for use in similar environments by guests in hotel or motel rooms, bed & breakfasts and other typical living quarters. This does not include common/shared facilities or commercial facilities within hotels, motels or bed & breakfasts.
- ▶ The appliance is not suitable for outdoor use.
- ▶ It must only be used to extract vapours and remove odours from cooking.
Any other usage is at the owner's risk. Miele cannot be held liable for damage resulting from incorrect or improper use or operation.
- ▶ Where a recirculation rangehood is fitted above a gas cooktop, please ensure that there is an adequate supply of fresh air into the room in which it is installed. Please seek the advice of a qualified gas fitter if necessary.

Warning and Safety instructions

▶ This appliance is not intended for use by persons (including children) with reduced physical, sensory or mental capabilities, or lack of experience and knowledge, unless they have been given supervision or instruction concerning its use by a person responsible for their safety, and are able to recognise the dangers of misuse.

Safety with children

▶ Young children must not be allowed to use this appliance.

▶ Older children may only use the appliance when its operation has been clearly explained to them and they are able to use it safely, recognising the dangers of misuse.

▶ Cleaning work may only be carried out by older children under the supervision of an adult.

▶ Children should be supervised near the appliance. Ensure that they do not play with the appliance.

▶ The cooktop lighting is very intense.

Ensure, in particular, that babies/small children do not look directly at the light.

▶ Danger of suffocation! Children may be able to wrap themselves in packing material or pull it over their head with the risk of suffocation. Keep children away from any packing material.

Warning and Safety instructions

Technical safety

- ▶ Repairs and other work by unqualified persons could be dangerous. Installation, maintenance work and repairs to electrical appliances must only be carried out by a Miele approved service technician.
- ▶ A damaged appliance can be dangerous. Check it for visible signs of damage. Do not use a damaged appliance.
- ▶ The electrical safety of this appliance can only be guaranteed when continuity is complete between it and an effective earthing system. It is most important that this basic safety requirement is present and tested regularly and, where there is any doubt, the household wiring system should be inspected by a qualified electrician.
- ▶ Reliable and safe operation of this rangehood can only be assured if it has been connected to the mains electricity supply.
- ▶ The connection data (voltage and frequency) on the data plate of the rangehood must match the mains electricity supply in order to avoid the risk of damage to the rangehood.
Compare this before connecting the appliance to the mains electricity. If in doubt, consult a qualified electrician.
- ▶ Do not connect the appliance to the mains electricity supply by a multi-socket unit or an extension lead. Extension leads are a fire hazard and do not guarantee the required safety of the appliance.
- ▶ EXT model rangehoods are connected to their external motor using a special connection cable and plug connectors.
These appliances may only be combined with a Miele external motor.

Warning and Safety instructions

▶ For safety reasons, this appliance may only be used after it has been built in.

▶ This rangehood must not be installed and operated in mobile installations (e.g. on a ship).

▶ Tampering with electrical connections or components and mechanical parts is highly dangerous to the user and can cause operational faults.

Only open the housing as described in the instructions given in the installation sheet and in the “Cleaning and care” section of this booklet. Under no circumstances should any other parts of the housing be opened.

▶ The manufacturer's warranty will be invalidated if the appliance is not repaired by a Miele approved service technician.

▶ Faulty components must only be replaced by genuine Miele spare parts. The manufacturer can only guarantee the safety of the appliance when Miele replacement parts are used.

▶ If the mains connection cable is damaged, it must only be replaced by a Miele authorised service technician or suitably qualified electrician in order to avoid a hazard.

▶ During installation, maintenance and repair work, the appliance must be disconnected from the mains electricity supply. It is only completely isolated from the electricity supply when:

- the mains circuit breaker is switched off, or
- it is switched off at the wall socket and the plug is withdrawn from the socket. Do not pull the mains connection cable but the mains plug to disconnect your appliance from the mains electricity supply.

Warning and Safety instructions

Using at the same time as another heating appliance that depends on the air from the room

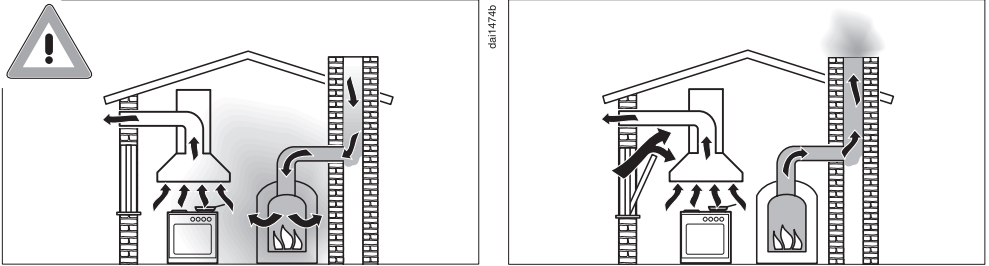

Danger of toxic fumes!

Great care should be taken when using the rangehood in the same room or the same area of the house as another heating appliance that depends on the air from the room.

Such heating appliances draw in air from the room and duct exhaust gases out through a chimney or extraction ducting. They include gas, oil, wood and coal-fired boilers and heaters, continuous flow or other water heaters, gas cooktops and ovens.

The rangehood draws in air from the kitchen and from neighbouring rooms. This applies to the following modes of operation:

- extraction mode,
- extraction mode with an external motor,
- recirculation mode with a recirculation box installed outside the room.

If there is insufficient air, an underpressure will occur. The heating appliance may be starved of oxygen. This impairs combustion. Harmful gases could be drawn from the chimney or extraction ducting back into the room, with potentially fatal consequences. Risk of death!

Warning and Safety instructions

In order to ensure safe operation and to prevent gases given off by a heating appliance from being drawn back into the room, when the rangehood and the heater are both operated simultaneously, an underpressure in the room of 0.04 mbar (4 Pa) is the maximum permissible.

Sufficient ventilation can be maintained by air inlets which cannot be blocked, e.g. in windows, doors and outside wall vents. The diameter of the inlet openings must enable sufficient ventilation. A ventilation brick alone is not generally sufficient to ensure safe ventilation.

The overall ventilation condition of the dwelling must be taken into account. If in any doubt, the advice of a competent builder, or for gas, a qualified gas fitter should be sought.

If the rangehood is being operated in recirculation mode, whereby the air is redirected into the room in which it is installed, the above restrictions do not apply.

Warning and Safety instructions

Correct use

- ▶ Never use an open flame beneath the rangehood. To avoid the danger of fire, do not flambé or grill over an open flame. When switched on, the rangehood could draw flames into the filter. Fat deposits could ignite, presenting a fire hazard.
- ▶ The rangehood can become damaged when exposed to excessive heat.
 - When using the rangehood over a gas cooktop, ensure that any burners in use are always covered by a pan. Switch the cooking zone off when a pan is removed, even for a short time.
 - Select a pan which is suitable for the size of the burner.
 - Regulate the flame so that it does not burn up the sides of the pan.
 - Avoid overheating the pan (e.g. when cooking with a wok).
- ▶ Always switch the rangehood on when a cooking zone is in use, otherwise condensation may collect in the rangehood, which could cause corrosion.
- ▶ Overheated oil and fat can ignite, causing fire damage to the rangehood. When cooking with oil or fat, chip pans and deep fat fryers etc., do not leave the pans unattended. Similarly, never leave an open grill unattended when grilling.

Warning and Safety instructions

- ▶ Do not use the rangehood without the filters in place. This way you will avoid the risk of grease and dirt getting into the appliance and hindering its smooth operation.
- ▶ The rangehood can get very hot during cooking due to heat rising from the cooktop.
Do not touch the housing or the grease filters until the rangehood has cooled down.
- ▶ This rangehood is not suitable for placing objects on.

Correct installation

- ▶ Refer to the cooktop manufacturer's instructions as to whether a rangehood may be operated above the cooktop.
- ▶ Safety regulations prohibit the fitting of a rangehood over solid fuel stoves.
- ▶ An insufficient safety distance between the stovetop and the rangehood can result in damage to the rangehood.
The minimum safety distances between the top of the stovetop and the bottom of the rangehood given in the “Installation” section of this booklet must be observed, unless the stovetop manufacturer states that a greater safety distance is required.
If more than one cooking appliance is fitted beneath the rangehood, and they have different minimum safety distances to the rangehood, select the greater distance.
- ▶ The distances given in “Installation” must be observed when fitting the rangehood.
- ▶ Metal parts can have sharp edges which may cause injury.
Wear gloves to protect your hands from being cut.
- ▶ All ducting, pipework and fittings must be of non-flammable material. These can be obtained from builders' merchants.

Warning and Safety instructions

- ▶ The appliance must not be connected to a chimney or vent flue which is in current use for exhausting fumes from appliances burning gas or other fuels. Neither should it be connected to ducting which ventilates rooms with fireplaces.
- ▶ If exhaust air is to be extracted into a chimney or ventilation duct no longer used for other purposes, seek professional advice.

Cleaning and care

- ▶ There is a risk of fire if cleaning is not carried out as described in these operating instructions.
- ▶ Do not use a steam cleaning appliance to clean this appliance. The steam could reach electrical components and cause a short circuit.
- ▶ In areas which may be subject to infestation by cockroaches or other vermin, pay particular attention to keeping the machine and its surroundings in a clean condition at all times. Any damage which may be caused by cockroaches or other vermin will not be covered by the machine warranty.

Accessories

- ▶ Use only genuine original Miele spare parts. If spare parts or accessories from other manufacturers are used, the warranty will be invalidated, and Miele cannot accept liability.

Disposal of the packing material

The transport and protective packaging has been selected from materials which are environmentally friendly for disposal, and can normally be recycled.

Recycling the packaging reduces the use of raw materials in the manufacturing process and also reduces the amount of waste in landfill sites. Ensure that any plastic wrappings, bags etc. are disposed of safely and kept out of the reach of babies and young children. Danger of suffocation.

Disposing of your old appliance

Electrical and electronic appliances often contain valuable materials. They also contain specific materials, compounds and components, which were essential for their correct function and safety. These could be hazardous to human health and to the environment if disposed of with your domestic waste or if handled incorrectly. Please do not, therefore, dispose of your old appliance with your household waste.



Please dispose of it at your local community waste collection / recycling centre for electrical and electronic appliances. You are also responsible for deleting any personal data that may be stored on the appliance prior to disposal. Please ensure that your old appliance poses no risk to children while being stored prior to disposal.

Guide to the appliance

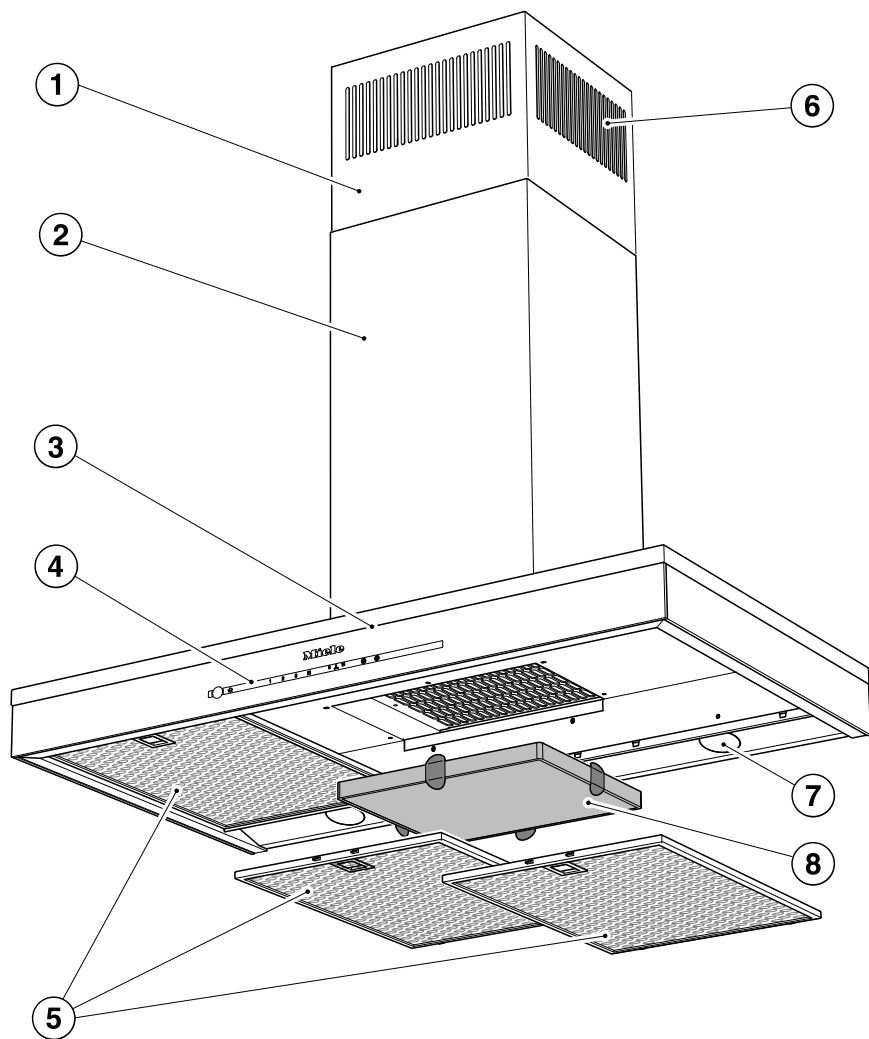

- ① Telescopic extension piece
- ② Tower
- ③ Canopy
- ④ Touch controls
- ⑤ Grease filters
- ⑥ Recirculation grilles
(only for recirculation mode)
- ⑦ Cooktop lighting
- ⑧ NoSmell active charcoal filter
(special accessory for recirculation mode)
- ⑨ Touch control for switching the fan on and off
- ⑩ Touch control for cooktop lighting
- ⑪ Touch controls for selecting the fan power setting
- ⑫ Touch control for the run-on option
- ⑬ Operating hours control for the grease filters
- ⑭ Operating hours control for the charcoal filter

Description of the functions

Depending on the model of the rangehood, the following options are available:

Air extraction mode

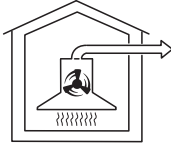

da100494a

The air is drawn in and cleaned by the grease filters and directed outside.

Non-return flap

The non-return flap is designed to prevent the exchange of room and outside air taking place.

The flap is closed when the rangehood is switched off.

When the rangehood is switched on, the non-return flap opens for the cooking vapours to be blown directly outside.

If the on-site ventilation system does not have a non-return flap, the non-return flap supplied must be fitted.

Recirculation mode

(available as an optional extra with a conversion kit and charcoal filter: see “Technical Data”)



da100494b

The air is drawn in and cleaned first by the grease filters and then by a charcoal filter. The cleaned air is then recirculated back into the kitchen.

Operation with an external motor

(...EXT model rangehoods)

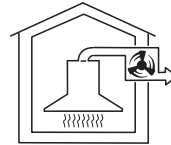



da100494c

Rangehoods designed for use with an external motor have to be connected to a Miele external motor located in a position of your choice outside the room. The external motor is connected to the rangehood by means of a control cable and is operated via Con@ctivity or by the controls on the rangehood.

Selecting extraction mode or recirculation mode

The rangehood can be operated with either extraction mode or recirculation mode. The power of the fan is adapted to suit the selected mode of operation. The rangehood is set up at the factory for recirculation mode. It has to be re-set for extraction mode.

To re-set it for extraction mode the operating hours counter for the charcoal filter(s) has to be deactivated.

- Switch off the fan and the lighting.
- Touch the run-on control  and the charcoal filter control  at the same time.

The charcoal filter symbol  and one of the fan power settings will flash.

- Touch the **B** control.
- Confirm your choice by touching the charcoal filter touch control .

All the indicator lights will go out.

Extraction mode has now been set.

If you do not confirm your selection within 4 minutes, the rangehood will automatically revert to the previous setting.

Setting up Miele@home

Prerequisite:

- Home Wi-Fi network

Your rangehood is equipped with an integrated Wi-Fi module. The rangehood can be connected to the household Wi-Fi network.

You will then be able to operate the rangehood via the Miele@mobile App.

If your Miele cooktop is connected to a home Wi-Fi network, you can control the rangehood automatically via the Con@ctivity function.

Before installing the rangehood in its final location, ensure that the signal of your Wi-Fi network is strong enough.

Please note that you cannot set up a Wi-Fi connection at the same time as the radio frequency Con@ctivity 2.0 system.

Before using for the first time

Miele@mobile App

You can download the Miele@mobile App from the Apple App Store® or the Google Play Store™ free of charge (only functional in selected countries).



Connecting via the App

The Miele@mobile App can be used to connect to your network.

- Install the Miele@mobile App on your mobile device.

To log in you will need:

1. Your Wi-Fi network password
2. Your rangehood password



The password for your rangehood consists of the last nine digits of the serial number. This can be found on the appliance's data plate.

The data plate is visible after removing the grease filters.



- Start signing the appliance on in the App. Follow the signing in instructions.

If requested to activate Wi-Fi on the rangehood, proceed as follows:

Before using for the first time

- Manually switch the rangehood off.



- Press and hold the **B** control.

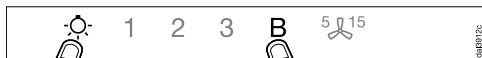

- Touch the lighting control at the same time .

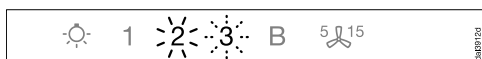

2 will light up constantly, **3** will flash.

The rangehood is ready for connection during the next two minutes.



- Follow the instructions in the App.

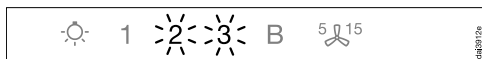

When successfully connected **2** and **3** will light up constantly.



- Quit connection mode on the rangehood by touching the run-on control .

The rangehood can now be operated via the App.

Connecting via WPS

Your Wi-Fi router must support WPS (Wi-Fi Protected Setup).

- Manually switch the rangehood off.

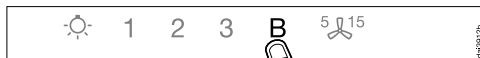

- Press and hold the **B** control.

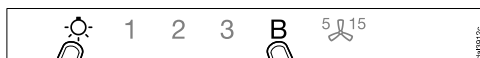

- Touch the lighting control at the same time .

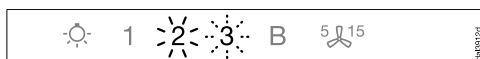

2 will light up constantly, **3** will flash.

The Wi-Fi connection must be started on the rangehood at the same time as on the Wi-Fi router.

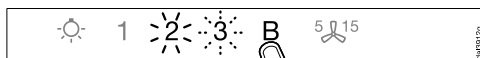

- Press the **B** control on the rangehood after a few seconds.

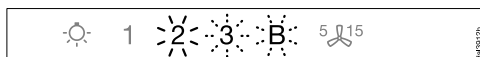

After a short while **2** will light up constantly, and **3** and **B** will flash on and off.

The rangehood is ready for connection during the next two minutes.

Before using for the first time



- Start the Wi-Fi connection on your Wi-Fi router.

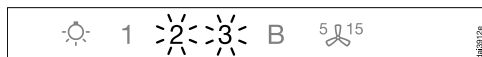

When successfully connected **2** and **3** will light up constantly.



- Quit connection mode on the rangehood by touching the run-on control **5** with a paperclip icon.

The rangehood can now be operated via the App.

If the connection fails, you have probably not connected WPS to your router quickly enough. Repeat the steps above.

Useful tip: If your Wi-Fi router does not support WPS, please connect via the Miele@mobile App.

Signing out of Wi-Fi (reset to factory settings)

To set up a new Wi-Fi connection, the existing Wi-Fi connection must first be disconnected.

- Manually switch the rangehood off.



- Press and hold the **1** control.



- Touch the lighting control **1** at the same time.

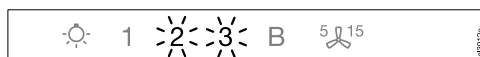

With an existing Wi-Fi connection **2** and **3** will light up constantly.

The rangehood is ready for disconnection during the next two minutes.

Before using for the first time



- Touch the **1** control.

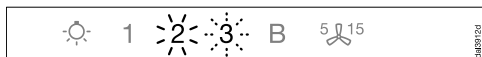

2 will light up constantly, **3** will flash on and off.

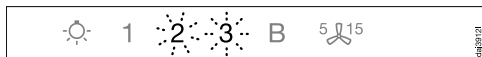

After a few seconds **2** and **3** will flash on and off. The connection has now been disconnected.



- Quit disconnection mode on the rangehood by touching the run-on control **5** .

The Wi-Fi connection has been disconnected. A new connection can now be set up.

Setting up Con@ctivity

Con@ctivity is the direct communication system between an electric Miele cooktop and a Miele rangehood. It enables the rangehood to operate automatically depending on the operational state of a Miele cooktop with onset controls.

- When the cooktop is switched on, the cooktop lighting on the rangehood comes on independently and, after a short time, the fan also switches on.
- The rangehood selects the power setting automatically during cooking. The power level selected by the rangehood depends on the number of cooking zones being used and their power levels.
- After switching the cooktop off, the fan and the cooktop lighting will switch off automatically after a specified period of time.

See “Operation” for detailed information about this function.

Before using for the first time

This rangehood can be operated with the Con@ctivity function via a Wi-Fi connection (Con@ctivity 3.0) or via a radio frequency connection (Con@ctivity 2.0).

Con@ctivity via the home Wi-Fi network (Con@ctivity 3.0)

Prerequisite:

- Home Wi-Fi network
- Wi-Fi enabled Miele cooktop

- Connect the rangehood and cooktop to your home Wi-Fi network (see “Setting up Miele@home”).

The Con@ctivity function will be activated automatically.

Con@ctivity via a direct Wi-Fi connection (Con@ctivity 3.0)

Prerequisite:

- Wi-Fi enabled Miele cooktop

If you do not have a home network, you can establish a direct connection between the cooktop and the rangehood.

See the cooktop operating instructions for details on how to connect them.

Instructions on how to connect the rangehood are repeated in detail below.

- Manually switch the rangehood off.



- Press and hold the **B** control.



- Touch the **1** control at the same time.

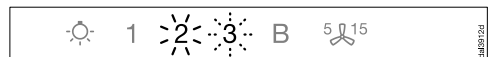

2 will light up constantly, **3** will flash on and off.

The rangehood is ready for connection during the next two minutes.

Before using for the first time

- Start the Wi-Fi connection on the cooktop. For further details, see the cooktop operating instructions.

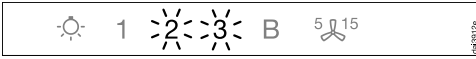

When successfully connected **2** and **3** will light up constantly.



- Quit connection mode on the rangehood by touching the run-on control ⁵15.

Con@ctivity has now been activated.

With a direct Wi-Fi connection, it is not possible to connect the cooktop and the rangehood to a home network. Should this be required at a later date, the direct Wi-Fi connection between the cooktop and the rangehood must be disconnected (see “Signing out of Wi-Fi”).

Con@ctivity with radio frequency connection (Con@ctivity 2.0)

Prerequisite:

- Con@ctivity 2.0 enabled Miele cooktop

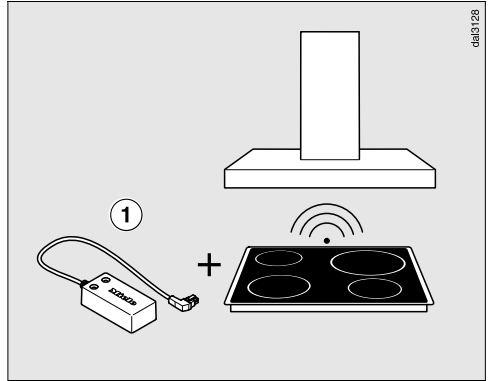

This rangehood is supplied with a Con@ctivity 2.0 radio frequency stick ①.

The radio frequency stick can only be used with cooktops that are fitted with a slot for the radio frequency stick to operate the Con@ctivity function.

- Check the installation instructions for the Con@ctivity 2.0 stick to ensure that it is compatible with your cooktop.

Please note that you cannot set up a Wi-Fi connection at the same time as the radio frequency Con@ctivity 2.0 system.

Before using for the first time

Installing the Con@ctivity 2.0 stick

- See the relevant installation instructions provided with the Con@ctivity 2.0 stick.

Activating the radio frequency connection

The rangehood and the cooktop must be installed and operational.

Radio frequency connection must be activated on the rangehood and the cooktop at the same time. Activation on the rangehood is described below.

Activation on the cooktop is described in the relevant operating and installation instructions. Please refer to the operating instructions before starting. Activate the rangehood first, then the cooktop.

Activating the rangehood

- The cooktop and rangehood must be switched off.

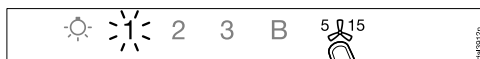

- Touch the run-on control 5 15 for approx. 10 seconds until **1** lights up.

- Then touch in turn



- the **1** control,

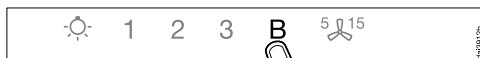

- then the **B** control,



- then the lighting control .

The rangehood is now in signing on/off mode.

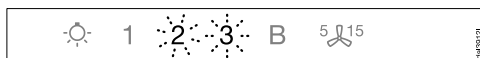

If a radio frequency connection has not yet been established, **2** and **3** will flash at the same time.

If a radio frequency connection has already been established, **2** and **3** will light up constantly (Con@ctivity 2.0 is already activated or a remote control is signed on).

Before using for the first time



- Touch the **B** control to activate Con@ctivity 2.0.

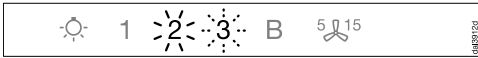

2 will light up constantly, **3** will flash on and off.

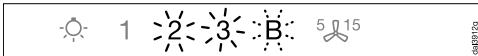

After a few seconds **2** and **3** will light up constantly, **B** will flash on and off.

The search for a radio frequency connection will start.

Activating the cooktop



- **While** the rangehood is searching for a signal, start activating the cooktop. For further details, see the cooktop operating instructions.
- When the cooktop registers that a connection has been established, exit activation on the cooktop.

Finishing activation on the rangehood

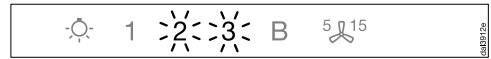

When successfully connected **B** will go out, and **2** and **3** will light up constantly.



- Confirm activation with the run-on control **5 15**. All the indicator lights will go out.

The Con@ctivity 2.0 function is now ready for use.

If you do not confirm your selection within 4 minutes, activation will not take place.

You only need to carry out the activation procedure once. If the appliances are disconnected from the electricity supply, for example during a power cut, they will still remain activated.

Before using for the first time

Activation failed

If connection cannot be established despite activating the rangehood and cooktop, the function must be deactivated on both appliances and then the procedure repeated.

Deactivating the radio frequency connection

- The cooktop and rangehood must be switched off.



- Touch the run-on control 5 15 for approx. 10 seconds until 1 lights up.

- Then touch in turn



- the **1** control,



- then the **B** control,



- then the lighting control ☀.

The rangehood is now in signing on/off mode.

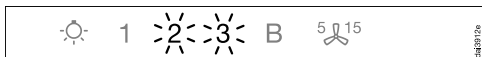

If a radio frequency connection has been established, 2 and 3 will light up constantly.



- Touch the **1** control to deactivate Con@ctivity 2.0.

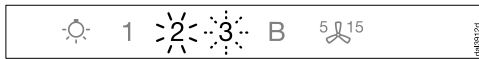

2 will light up constantly, **3** will flash on and off.

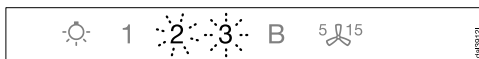

After a few seconds **2** and **3** will start flashing on and off.

The radio frequency connection has been deactivated.

- To deactivate the cooktop, please refer to the operating instructions supplied with it.

Please bear in mind that disabling the signal will also disable any remote control function and this will have to be activated again.

Operation (automatic mode)

When Con@ctivity 2.0 is active, the rangehood always operates in automatic mode (see “Setting up Con@ctivity 2.0”).

If you wish to manually operate the rangehood, see “Cooking without Con@ctivity”.

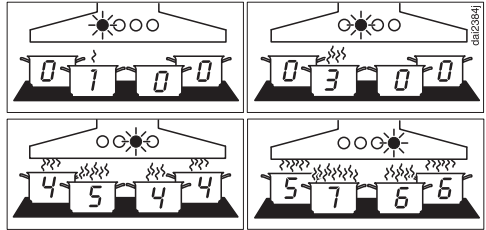

Examples for power levels **1** to **B**

Cooking with Con@ctivity (automatic mode)

- Switch a cooking zone on at the power setting you want.

The cooktop lighting will come on.

After a few seconds the fan will switch on, first at power setting **2**, then it will switch immediately to power setting **1**.

The rangehood selects the power setting automatically during cooking.

This is determined by the total output of the cooktop, i.e. the number of cooking zones in operation and the power settings selected.

- If you select a higher power setting or are using several cooking zones, the rangehood will switch to a higher power setting.
- When you reduce the power setting or the number of cooking zones being used, the rangehood power setting will also be reduced.

Reaction time

The rangehood reacts with a slight delay because altering the power setting on the cooktop does not immediately result in a reduction or increase in cooking vapours.

Because the cooktop transmits the information to the rangehood at intervals, this can also cause delays.

The reaction can vary from a few seconds to a few minutes.

Operation (automatic mode)

Cooking process

- If for example you switch on a cooking zone at the highest power level to heat a pan for frying and reduce the power level after approx. 10 seconds to 4 minutes *, a cooking process is recognised. (*60 seconds to 5 minutes for a HiLight cooktop.)

The rangehood switches itself on and when the cooktop power level has been reduced, the rangehood switches to power setting 3 and remains at that level for approx. 5 minutes.

After that the rangehood power setting is determined automatically by the Con@ctivity function.

- You can select another power setting manually before then.

Switching off

- Switch off all cooking zones.

The rangehood fan will reduce its power level in stages over the next few minutes and will then switch itself off.

This helps to neutralise any lingering vapours and odours in the air.

- From the Booster setting, the fan switches immediately to level 3.
- From level 3, it will switch to level 2 after approx. 1 minute.
- From level 2, it will switch to level 1 after 2 minutes.
- After 2 minutes at Level 1, the fan switches itself off.
- After another 30 seconds, the cooktop lighting switches off.

The cooking process is then finished.

Leaving automatic mode temporarily

To leave automatic mode temporarily during cooking:

- Manually select a different power setting, or
- Manually switch the rangehood off, or
- Activate the run-on function  on the rangehood. The fan will switch itself off after the selected run-on time, and the lighting will remain on.

The rangehood functions can now be operated manually (see “Cooking without Con@ctivity”).

Returning to automatic mode

The rangehood returns to automatic mode:

- if the rangehood has not been used for approx. 5 minutes after selecting a power setting manually, or
- if the manually selected power setting corresponds to the automatic one again, or
- if the rangehood fan and the cooktop have been switched off for at least 30 seconds.
Automatic mode will resume next time the cooktop is switched on.

You can also operate the rangehood manually for a complete cooking process.

- To do so switch the rangehood fan on **before** the cooktop.

If the rangehood fan and the cooktop have been switched off for at least 30 seconds after cooking, automatic mode will resume next time the cooktop is switched on.

Operation (manual mode)

Cooking without Con@ctivity (manual mode)

The rangehood can be operated manually if:

- the Con@ctivity function is not activated.
- you have temporarily deactivated the Con@ctivity function (see “Temporarily exiting automatic mode”).

Switching the fan on

Switch the fan on as soon as you start cooking. This is to ensure that vapours are captured right from the start.

- Touch the On/Off control .

The fan will come on at power setting **2**.

Selecting a power setting

For light to heavy cooking vapours and odours, select from power settings **1** to **3**.

For short periods of cooking food with intensive vapours and a strong aroma, e.g. when searing meat, select Booster setting **B**.

- Select the power setting required by touching a control from **1** to **B**.

Reducing power down from the Booster setting





If Power management is activated (default setting), the fan automatically switches back to level **3** after 5 minutes.

Selecting the run-on time

It is advisable to run the fan for a few minutes after cooking has finished. This helps to remove any lingering vapours and odours from the air.

It also reduces the risk of residues accumulating in the rangehood and any resultant odours.

The run-on function allows the fan to continue to run for a pre-determined time before switching itself off automatically.

- After you have finished cooking, touch the run-on control  with the fan still switched on:
 - Once: the fan will switch itself off after 5 minutes (**5**  lights up).
 - Twice: The fan will switch itself off after 15 minutes ( **15** lights up).
 - If you touch the run-on control  again, the fan will remain switched on ( will go out).

Switching the fan off



- Press the On/Off touch control  to switch the fan off.

Dimming/switching the cooktop lighting on/off

The cooktop lighting can be switched on and off and dimmed independently of the fan.

- Press the lighting sensor  briefly to switch it on or off.

The lighting will switch on at maximum brightness.

- To change the brightness, press and hold the lighting control  with the lighting switched on. The brightness will gradually dim until you release the control.
- To increase the brightness, press and hold the lighting  control again until the desired level has been reached and then release it.

Power management

The rangehood features a Power management system to help save energy. The fan power setting is reduced and the lighting is switched off automatically.



- If the Booster setting has been selected, the fan will automatically switch to setting 3 after 5 minutes.
- From settings 3, 2 or 1 the power will be reduced by one setting after 2 hours and then in 30-minute stages until the fan finally switches off.
- The cooktop lighting will switch off automatically after 12 hours.

You can deactivate Power management.

This can, however, result in increased electricity consumption.

Operation (manual mode)

Switching Power management on/off

- Switch off the fan and the lighting.
- Touch the run-on control  for approx. 10 seconds, until **1** lights up in the power settings display.
- Then touch in turn
 - the lighting control ,
 - the **1** control and then again
 - the lighting control .

If Power management is switched on, the **1** and **B** indicators light up constantly.

When it is switched off, the **1** and **B** indicators flash.

- Touch the **1** control to switch Power management off.

The **1** and **B** indicators will flash.

- Touch the **B** control to switch it on.

The **1** and **B** indicators will light up constantly.



- Confirm the setting by pressing the run-on control .

All the indicator lights will go out.

If you do not confirm your selection within 4 minutes, the rangehood will automatically revert to the previous setting.

Safety switch-off



If Power management has been deactivated, the rangehood will switch itself off automatically after 12 hours if it has been left on (fan and cooktop lighting).

- To switch it back on press the On/Off  control or the lighting control .

Operation (automatic and manual modes)

Operating hours counter

The rangehood registers the length of time it has been operated.



When the grease filter symbol  or the charcoal filter symbol  lights up, the operating hours counters are signalling that the filters need to be cleaned or replaced. Further information about cleaning and replacing the filters and resetting the operating hours counters can be found under “Cleaning and care”.

Altering the grease filter operating hours counter

You can set the operating hours counter to suit the type of cooking you do.

It is set at the factory for 30 hours.

- Select a shorter time of 20 hours if you fry a lot.
- If you only cook occasionally, we recommend that you still select a short time for the counter. This is to prevent grease from hardening on the filters and making cleaning more difficult.
- If you use very little fat for cooking, you can select a longer time (40-50 hours).

- Switch off the fan and the lighting.
- Touch the run-on control ⁵ and the grease filter control  at the same time.

The grease filter symbol  and one of the fan power setting indicators will flash.

The fan power setting indicators **1** to **B** show the time set:

1	20 hours
2	30 hours
3	40 hours
B	50 hours

- Touch the relevant control to select the duration required.
- Confirm your choice by touching the grease filter control .

All the indicator lights will go out.

If you do not confirm your selection within 4 minutes, the rangehood will automatically revert to the previous setting.

Operation (automatic and manual modes)



Altering or deactivating the charcoal filter operating hours counter

The charcoal filter is needed for recirculation mode.

You can set the operating hours counter to suit the type of cooking you do.

It has to be deactivated for extraction mode.

It is set at the factory for 180 hours of use before it needs to be replaced.

- Switch off the fan and the lighting.
- Touch the run-on control  and the charcoal filter control  at the same time.

The charcoal filter symbol  and one of the fan power settings will flash.

The fan power setting indicators **1** to **B** show the time set:

- 1**..... 120 hours
- 2**..... 180 hours
- 3**..... 240 hours
- B**..... deactivated



- Touch the relevant control to select the duration required.
- Confirm your choice by touching the charcoal filter touch control .

All the indicator lights will go out.

If you do not confirm your selection within 4 minutes, the rangehood will automatically revert to the previous setting.

Reading the filter operating hours counter

You can check the percentage of time set already used before the filters need replacing.

- Switch the fan on with the On/Off touch control .
- Press and hold the grease filter control  or the charcoal filter control .

One or more of the power setting indicators will flash.

The number of flashing indicators shows the percentage of the operating time which has already been used up.

- 1** 25 %
- 1 and 2** 50 %
- 1 to 3** 75 %
- 1 to B** 100 %

The number of operating hours used remains in the memory even when the appliance is switched off or there is a power cut.

This rangehood operates very efficiently and economically. The following will help you to save even more energy when using it:

- Ensure that there is sufficient ventilation in the kitchen when cooking. In extraction mode, if there is insufficient air flow the rangehood cannot operate efficiently and this causes increased operating noise levels.
- Always cook with the lowest possible setting. This produces fewer cooking vapours, so you can use a lower rangehood power level and therefore benefit from reduced energy consumption.
- Clean or change the filters at regular intervals. Heavily soiled filters reduce performance, increase the risk of fire and are unhygienic.
- Use the Con@ctivity function. The rangehood will switch on and off automatically at the optimum power level for the cooking you are doing, which ensures low energy consumption.
- If you are operating the rangehood manually, please note the following:
 - Check the power level selected on the rangehood. A low power level is usually sufficient. Only use the Booster setting when necessary.
 - When a large volume of cooking vapours are being produced, switch to a high power level in good time. This is more efficient than operating the rangehood for longer to try to capture cooking vapours which have already been distributed throughout the kitchen.
 - Make sure that you switch the rangehood off after use. If cooking vapours and odours still need to be removed from the kitchen air after cooking, use the run-on function. The fan will switch off automatically after the selected run-on time.

Cleaning and care

 Before proceeding with any maintenance or cleaning task, the rangehood must be disconnected from the power supply (see “Warning and Safety instructions”).

Housing

General

 The surfaces and controls are susceptible to scratches and abrasion.

Please observe the following cleaning instructions.

- All external surfaces and controls can be cleaned using warm water with a small amount of washing-up liquid applied with a well wrung-out soft sponge or cloth.
- After cleaning, wipe the surfaces dry using a soft cloth.

Do not use:

- cleaning agents containing soda, acids, chlorides or solvents,
- abrasive cleaning agents, e.g. powder cleaners or cream cleaners and abrasive sponges, as well as pot scourers or sponges which have been used previously with abrasive cleaning agents. These will damage the surface material.

Important for appliances with stainless steel surfaces

- Stainless steel surfaces can be cleaned with a proprietary non-abrasive cleaning agent designed specifically for use on stainless steel, e.g. Original Miele ceramic and stainless steel cooktop cleaner.
- To help prevent re-soiling, a proprietary conditioning agent for stainless steel (Original Miele Care product for stainless steel) can also be used.
Apply sparingly with a soft cloth following the instructions on the packaging.

Important for appliances with lacquered housing

- Observe the general notes on cleaning earlier in this section.

Minor scratches on the surface are inevitable when cleaning the housing. Depending on the lighting in the kitchen, this may negatively affect the appliance's appearance.

Important for appliances with glass surfaces

- Glass surfaces can be cleaned using a proprietary non-abrasive cleaning agent designed specifically for use on glass.

Grease filters

⚠ Fire hazard!

Oversaturated grease filters are a fire hazard.

Clean the grease filters at regular intervals.

The re-usable metal grease filters in the appliance remove solid particles (grease, dust, etc.) from the kitchen vapours, preventing soiling of the rangehood.

The grease filters must be cleaned at regular intervals.

Heavily soiled grease filters hinder air extraction and will lead to increased levels of soiling in the rangehood and in the kitchen.

Grease filter cleaning intervals

Accumulated grease solidifies over a longer period of time and makes cleaning more difficult. The grease filters should therefore be cleaned every 3 to 4 weeks.

The operating hours control reminds you to regularly clean the grease filters by illuminating the grease filter symbol .

- You can set the operating hours counter interval to suit the type of cooking you do (see “Operation”).

Removing the grease filter

⚠ When handling the grease filter, be careful not to drop it.

This can result in damage to the filter and the cooktop below.

Make sure you hold the filter securely at all times when handling it.

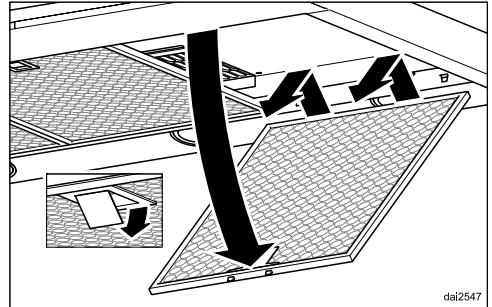

- To take out the grease filter, release the locking clip on the filter, lower the filter approx. 45°, unhook it at the back and remove it.

Cleaning the grease filters by hand

- Clean the filters with a soft nylon brush in a mild solution of hot water and a small amount of washing-up liquid. Do not use undiluted washing up liquid.

Cleaning and care

Unsuitable cleaning agents

Unsuitable cleaning agents can cause damage to the surface of the filters if used regularly.

Do not use:

- cleaning agents containing descaling agents,
- powder cleaners or cream cleaners,
- aggressive all-purpose cleaning agents or spray cleaners for grease,
- oven sprays.

Cleaning the grease filters in the dishwasher

- Place the grease filters upright or slightly inclined in the lower basket. Ensure the spray arm is not obstructed.
- Use a standard household dishwasher detergent.
- Select a dishwasher programme with a wash temperature between 50 °C and 65 °C.

Depending on the detergent used, cleaning the filters in the dishwasher may cause the inside filter surfaces to become discoloured. This will not affect the functioning of the grease filters in any way.

After cleaning

- After cleaning, leave the filters to dry on an absorbent surface before refitting them.
- When removing the filters for cleaning, also clean off any residues of oil or fat from the now accessible housing to prevent the risk of these catching fire.
- Replace the grease filters, making sure that the locking clips are facing down towards the cooktop.

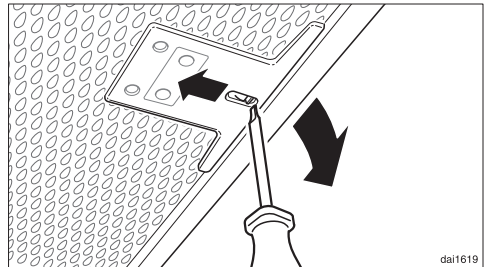

- If a grease filter is inadvertently refitted upside down, insert a small screwdriver blade into the slit to disengage the clip.

Resetting the grease filter operating hours counter

After cleaning, the operating hours counter needs to be reset.

- With the fan is switched on, press the grease filter control  for approx. 3 seconds, until only **1** is flashing.

The grease filter symbol  goes out.

If the grease filters are cleaned before the operating hours counter has reached its maximum:

- Touch the grease filter control  for approx. 6 seconds, until only **1** is flashing.

NoSmell active charcoal filter

With recirculation mode, a charcoal filter must be fitted in addition to the grease filters. The charcoal filter is designed to absorb cooking odours.

The charcoal filter is fitted in the canopy above the grease filters.

Fitting/replacing the charcoal filter

- Remove the grease filters before fitting or replacing the charcoal filter.
- Take the charcoal filter out of its packaging.

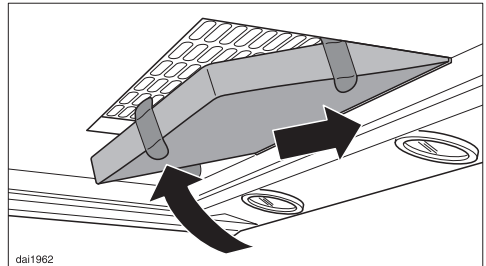

- Insert the charcoal filter into the back of the charcoal filter frame, then push up into the frame at the front.
- Refit the grease filters.

Cleaning and care

When to change the NoSmell active charcoal filter

- Replace the charcoal filter when it no longer absorbs kitchen odours effectively.
It should be replaced at least every 6 months.

The operating hours counter will remind you to replace the charcoal filter by lighting up the charcoal filter symbol .

Resetting the charcoal filter operating hours counter

After changing the charcoal filter, the operating hours counter needs to be reset.

- Touch the charcoal filter control  for approx. 3 seconds with the rangehood switched on until only the indicator light for setting **1** is flashing.

The charcoal filter symbol  goes out.

If you want to replace the charcoal filter **before** the operating hours counter has reached its maximum:

- Touch the charcoal filter control  for approx. 6 seconds until only the indicator light for setting **1** is flashing.

Disposing of the charcoal filter

- The used charcoal filter can be disposed of with the normal household waste.

Reactivatable charcoal filter

A reactivatable charcoal filter is available for this rangehood. By reactivating it in an oven, it can be reused several times.

- It is supplied with its own installation and usage instructions which must be observed.

Charcoal filters are available to order via the Miele online shop (see end of this booklet for contact details) or directly from Miele.

The charcoal filters are listed under “Technical data” at the back of this booklet.

Before installation

 Before installation, it is important to read the information given on the following pages as well as the “Warning and Safety instructions” at the beginning of this booklet.

Protective foil

The housing components have protective foil around them to prevent them from transport damage.

- Please remove this foil before fitting the housing components. It can be peeled off easily.

Installation instructions

See enclosed installation sheet for instructions on how to install this appliance.

 Failure to install the screws or fixing device in accordance with these instructions may result in electrical hazards.

Dismantling

Should the appliance ever need to be dismantled, follow the installation instructions in reverse order as described on the installation sheet. A lever is supplied to assist with the removal of the tower.

- Unscrew the two fixing screws on the tower.

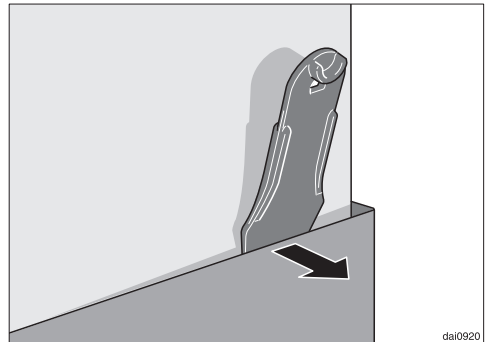

- Push the lever between the tower and the extension piece.
- Lever the tower out of its fixings.

Installation

Assembly parts

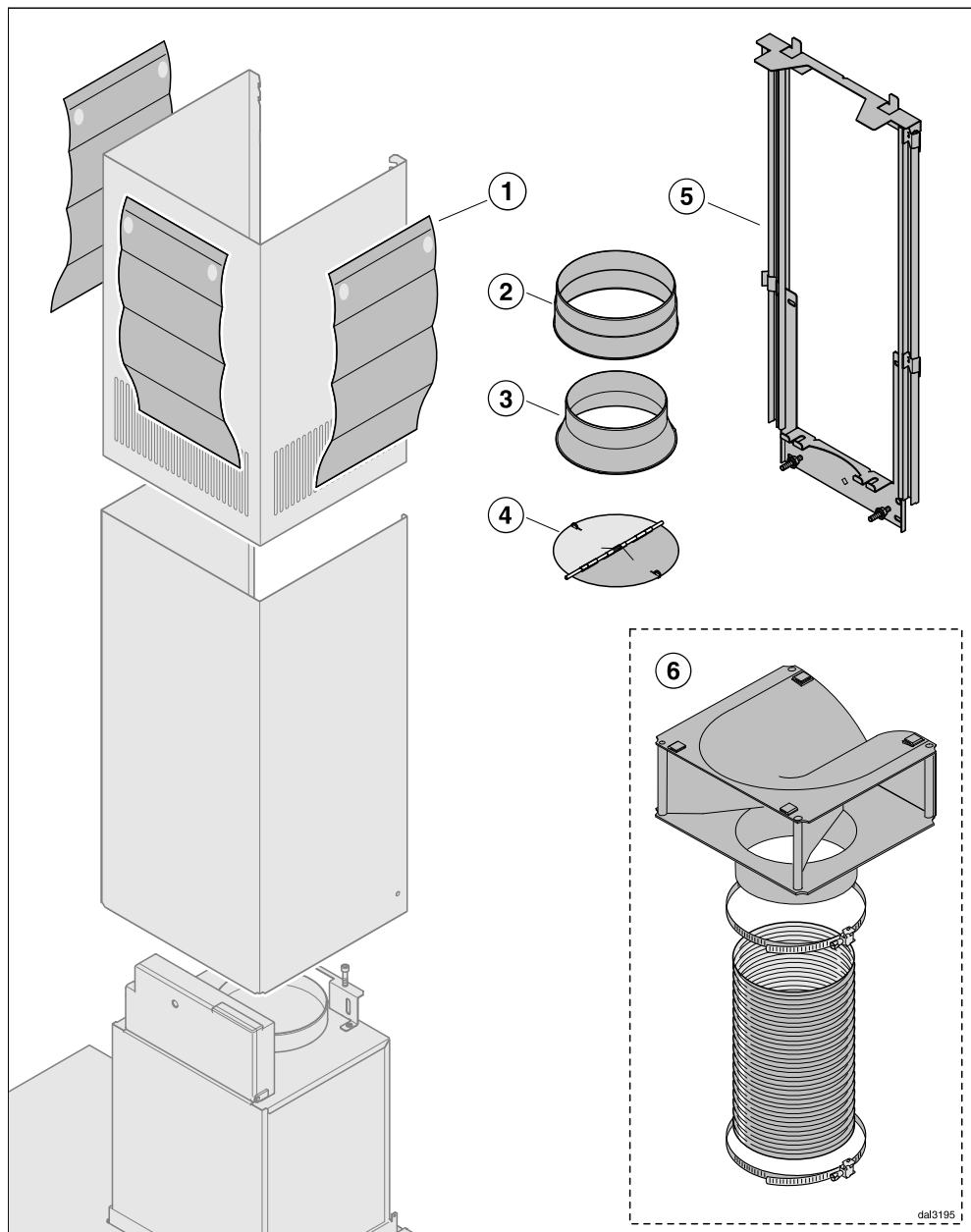

- ① **3 protective sheets**
for use when fitting the tower.
- ② **1 exhaust connection**
for exhaust ducting \varnothing 150 mm.
- ③ **1 reducing collar**
for exhaust ducting \varnothing 125 mm.
- ④ **1 non-return flap**
for installation in the exhaust connection on the motor unit (not for recirculation mode). The non-return flap may already be fitted depending on model.
- ⑤ **Telescopic wall bracket**
for securing the rangehood to the wall.
- ⑥ **Conversion kit for recirculation mode**
including directional unit, flexible aluminium hose and hose clips (the conversion kit is not supplied. It is available as an optional accessory - see "Technical data").



5x60mm-DIN9135

6 screws 5 x 60 mm and
6 plugs 8 x 50 mm
for securing the rangehood to the wall.

⚠ The screws and plugs are designed for use in solid walls only. For other types of wall construction, alternative fixings will be required. Make sure the wall is able to take the weight of the rangehood.



0001682

2 x M 6 self-tapping nuts
for securing the appliance.



02256130

2 screws 3.9 x 7.5 mm
for securing the tower.

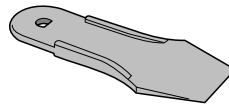

00033716

1 lever
for dismantling the tower.

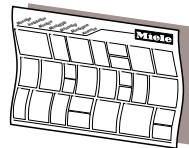

dinaSmile

Installation instructions

Installation

Appliance dimensions

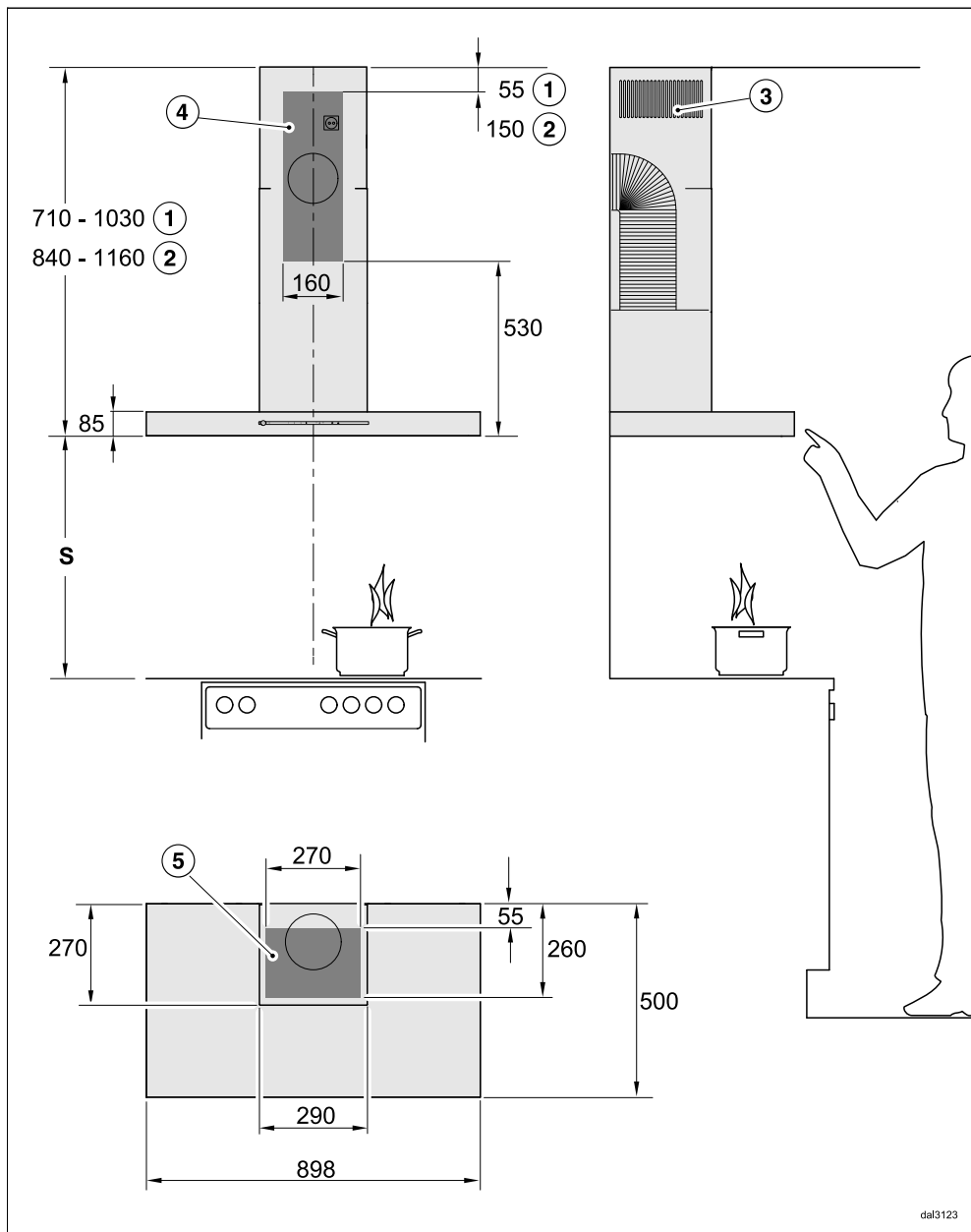

dal3123

The drawing is not to scale.

- ① Extraction
- ② Recirculation
- ③ Ventilation grille positioned at the top for recirculation
- ④ ⑤ (only ④ is required for recirculation mode rangehoods): The shaded area represents the wall or ceiling area for the vent cut-out, for fitting the connection socket and on EXT models for feeding the connection cable through to the external motor. Recirculation mode rangehoods only require an electrical connection socket.

Connection for air extraction \varnothing 150 mm, or \varnothing 125 mm with reducing collar.

Safety distance (S)

The minimum distances between the highest part of a cooktop (including trivets, dials - depending on model) and the bottom of the rangehood are as follows, unless a greater distance is specified by the manufacturer of your cooking appliance. See also "Warning and Safety instructions".

Installation

Cooking appliance	Minimum distance S
Electric cooktop	600 mm (AU, NZ) 450 mm (HK, MY, SG, TH)
Electric grill, deep fat fryer (electric)	650 mm
Multi-burner gas cooktop with maximum 45.4 MJ/h total output, with no burner having a greater output than 16.2 MJ/h.	650 mm
Multi-burner gas cooktop with total output greater than 45.4 MJ/h, but with a maximum of 77.8 MJ/h, with no burner having a greater output than 17.3 MJ/h.	760 mm
Multi-burner gas cooktop with total output greater than 77.8 MJ/h, with a single burner having a greater output than 17.3 MJ/h.	Not possible
Single burner gas cooktop with a maximum output of 21.6 MJ/h.	650 mm
Single burner gas cooktop with an output greater than 21.6 MJ/h, but with a maximum of 29.2 MJ/h.	760 mm
Single burner gas cooktop with an output greater than 29.2 MJ/h.	Not possible

Installation recommendations

- When deciding on the safety distance between the cooktop and rangehood, please note that a distance of 650 mm above electric cooktops may be preferable to give more working space under the rangehood.
- Account should also be taken of the height of the person who will be using the rangehood most often. They should have sufficient space to work comfortably at the cooktop, and be able to reach the rangehood controls with ease.
- If positioned too high, extraction will be inefficient.
- To achieve optimum vapour extraction, the rangehood must be positioned centrally over the cooktop, not to the side.
- The cooktop should be no wider than the rangehood and, if possible, it should be narrower, especially for safety distances greater than 750 mm.
- The installation area must be easily accessible. The rangehood should be easily accessible and easy to dismantle in the event that service is required. This should be taken into consideration when planning the position of cupboards, shelves, ceilings or features in the vicinity of the rangehood.

Drilling diagram for wall mounting

- Please follow the directions given in the installation instructions supplied for drilling.

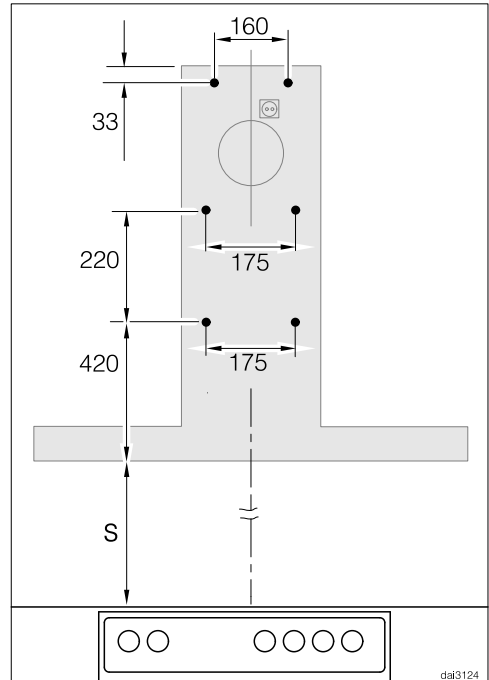

- For pre-installation of a back wall where the holes have to be pre-drilled, please refer to the drilling distances in the drawing above (screws \varnothing 5 mm).

Connection for air extraction

⚠ Before installation, it is important to read the information given on the following pages as well as the “Appliance dimensions” and the “Warning and Safety instructions” at the beginning of this booklet. This is particularly crucial when using the rangehood at the same time as a heating appliance that relies on oxygen from the same room, which could result in the build-up of toxic fumes.

The rangehood should be installed according to local and national building regulations. Seek approval from the building inspector where necessary.

Only use smooth pipes or flexible ducting made from approved non-flammable materials for exhaust ducting.

When using an external motor, make sure that the exhaust ducting is sufficiently rigid. The external motor can cause an underpressure which can result in the exhaust ducting distorting.

To achieve the greatest possible air extraction with the lowest noise level, please note the following:

- The diameter of the exhaust ducting should not be less than 150 mm.
- If flat ducting is being used, the cross-sectional area must not be smaller than the cross-sectional area of the exhaust connection.
- The exhaust ducting should be as short and straight as possible.

- Only use wide radius bends.
- The exhaust ducting must not be kinked or compressed.
- Ensure that all connections are strong and airtight.

Remember that any constriction of the airflow will reduce extraction performance and increase operating noise.

- If the exhaust is ducted through an outside wall, a telescopic wall vent or a roof vent (available as an optional accessory) is recommended.

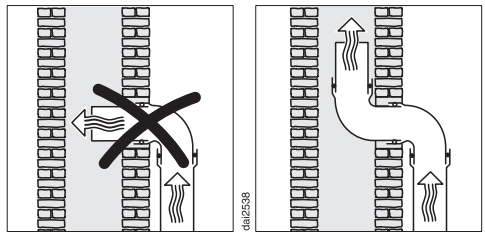

- If the exhaust air is to be ducted into a vent flue, the ducting must be directed in the flow direction of the flue.
- Where ducting is horizontal, it must be laid to slope away at at least 1 cm per metre. This is to ensure that condensate cannot drain back into the rangehood.
- If the exhaust ducting is to run through rooms, ceiling space etc. there may be great variations in temperature between the different areas. The problem of condensation will need to be addressed. The exhaust ducting will need to be suitably insulated.

Condensate trap

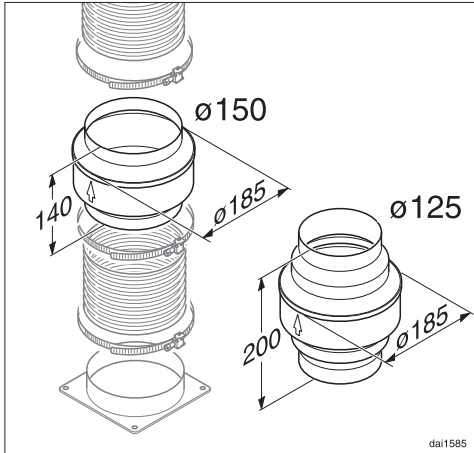

In addition to insulating the exhaust ducting, we recommend that a suitable condensate trap is also installed to collect and evaporate any condensate which may occur.

Condensate traps are available for 125 mm or 150 mm ducting.

- When installing a condensate trap, ensure that it is positioned vertically and, if possible, directly above the exhaust socket.

The arrow on the housing indicates the direction of airflow.

The condensate trap will be integrated in rangehoods which are designed to be connected to an external motor (...EXT models).

Silencer

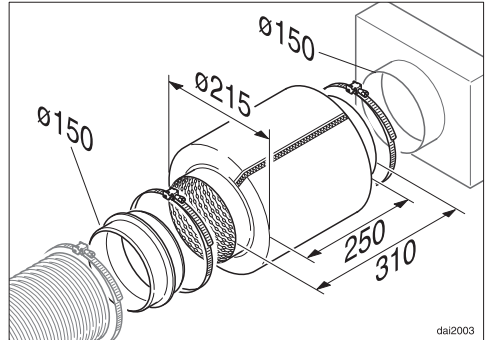

To achieve even further reductions in noise levels, a special silencer (optional accessory) can be fitted in the ducting system.

Air extraction mode

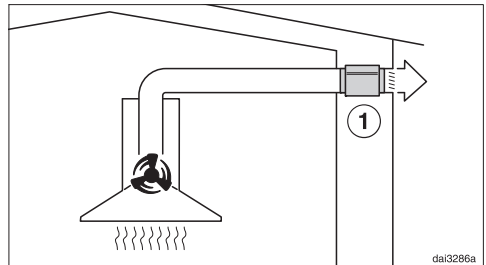

The silencer not only reduces noise from the motor outside the house, but also sounds from outside (e.g. traffic noise). For this reason, the silencer must be positioned as close as possible to the ducting exit ①.

Connection for air extraction

Recirculation mode

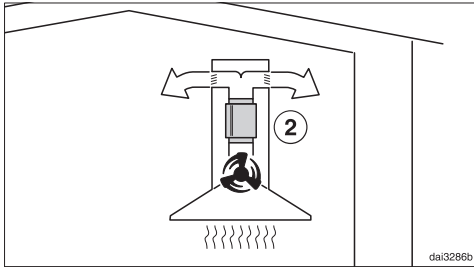

The silencer needs to be positioned between the exhaust connection and the directional unit ②. Ensure there is adequate space in the tower for fitting it.

Air extraction with external motor

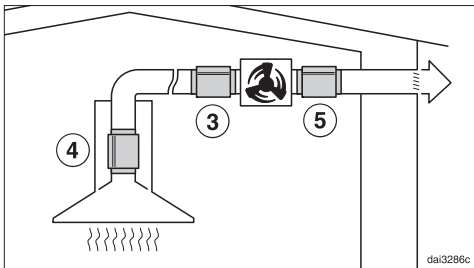

To minimise noise from the motor in the kitchen, the silencer should be positioned in front of the external motor ③ if possible, or, if the ducting is long, above the exhaust connection inside the rangehood ④. In the case of an external motor located inside the house, fitting a silencer behind the external motor ⑤ reduces the noise of the motor outside the house.

All electrical work must be undertaken by a suitably qualified and competent person in strict accordance with current national and local safety and building code regulations. Installation, repairs and other work by unqualified persons could be dangerous, for which the manufacturer cannot be held liable. Ensure power is not supplied to the appliance until after installation or repair work has been carried out.

The rangehood must be connected to a suitably earthed socket (AC 230 V, 50 Hz).

For extra safety it is advisable to install a residual current device (RCD) with a trip current of 30 mA.

Connection of this appliance must be made via a suitable isolator switch which provides disconnection on all poles and which complies with national and local safety regulations. The isolator switch should be easily accessible after the appliance has been built in.

If the mains socket is not accessible after installation, an additional means of disconnection must be provided for all poles. There must be an all-pole contact gap of 3 mm in the switch (including switch, fuses and relays).

The connection data is given on the data plate (See "After sales service"). Ensure that this data matches the household mains supply.

After sales service and warranty

In the event of a fault which you cannot remedy yourself, please contact Miele.

The contact details for Miele are given at the back of these instructions.

When contacting Miele, please quote the model and serial number of your appliance.

These can be found on the data plate.

Position of the data plate

The data plate is visible after removing the grease filters.

Warranty

AU, NZ:

The manufacturer's warranty for this appliance is 2 years.

For further information, please refer to your warranty booklet.

Other countries:

For information on the appliance warranty specific to your country please contact Miele. See the end of this booklet for contact details.

Technical data

Fan motor*	230 W
Cooktop lighting	3 x 3 W
Total rated load*	239 W
Voltage	AC 230 V, 50 Hz
Fuse rating	10 A
Mains connection cable length	1.5 m
Weight	
DA 6698 W	26 kg
DA 6698 W EXT	23 kg

* For EXT models, the rated load will depend on the type of external motor fitted.
Length of connection cable to external motor: 1.7 m

Wi-Fi module

Frequency band	2.412 - 2.462 GHz
Maximum transmitting power	< 100 mW

Radio frequency module (ZigBee)

Frequency band	2.405 - 2.48 GHz
Maximum transmitting power	< 10 mW

Optional accessory for recirculation mode

Conversion kit DUW 20 and one charcoal filter DKF 12-1 or DKF 12-R
(reactivatable)

Miele

Miele Australia Pty. Ltd.

ACN 005 635 398
ABN 96 005 635 398

Miele Experience Centre and
Head Office Melbourne:
1 Gilbert Park Drive
Knoxfield, VIC 3180



www.miele.com.au

Miele (Hong Kong) Limited

41/F - 4101, Manhattan Place
23 Wang Tai Road
Kowloon Bay
Hong Kong
Tel.: (852) 2610 1025
Fax: (852) 3579 1404
E-mail: customerservices@miele.com.hk
Website: www.miele.hk

Singapore

Miele Pte. Ltd.
163 Penang Road
04 - 03 Winsland House II
Singapore 238463
Tel.: +65-67351191
Fax: +65-67351161
E-mail: info@miele.com.sg
Internet: www.miele.sg

Miele Global Headquarters Germany

Miele & Cie. KG Carl-Miele-Straße 29, 33332 Gütersloh, Federal Republic of Germany

Miele New Zealand Limited

IRD 98 463 631

Head Office:

Level 2, 10 College Hill
Freemans Bay, Auckland 1011

Telephone:

0800 464 353 (0800 4 MIELE)
www.miele.co.nz

Malaysia

Miele Sdn Bhd
Suite 12-2, Level 12
Menara Sapura Kencana Petroleum
Solaris Dutamas No. 1, Jalan Dutamas 1
50480 Kuala Lumpur, Malaysia
Phone: +603-6209-0288
Fax: +603-6205-3768

Thailand

BHIRAJ TOWER at EmQuartier
43rd Floor Unit 4301-4303
689 Sukhumvit Road
North Klongton Sub-District
Vadhana District
Bangkok 10110, Thailand

DA 6698 W, DA 6698 W EXT

en-AU, NZ

M.-Nr. 10 910 680 / 00