

CROCK·POT®

Express Crock Multi-Cooker

User Guide

CPE200





Contents

Crock-Pot's Safety Precautions	1 - 2
Features of your Express Crock	3 - 4
Things to know about your Express Crock	5 - 6
Using your Express Crock	7
Time Delay Function	8
Pressure Cooking	9 - 11
Slow Cooking	12
Cooking Guide	13
Steaming	14 - 15
Brown/Sauté	16
Rice/Risotto	16 - 17
Care & Cleaning	18 - 20
Troubleshooting & Notification Codes	21-22
Hints & Tips	23

Important Instructions - retain for future use

تأكد من تفهم احتياطات السلامة المذكورة اعلاه

請務必理解上述的安全預防措施。

Assurez-vous que les précautions ci-dessus relatives à la sécurité sont bien comprises

Versichern Sie sich daß die obenstehenden Sicherheitsmaßnahmen Verstanden werden

Βεβαιώνετε πως οι παραπάνω προφυλάξεις ασφαλείας γίνονται κατανοητές

Pastikan bahwa tindakan-tindakan keselamatan seperti di atas dimengerti anda

Accertatevi che le suddette norme di sicurezza siano comprese a dovere

上記の注意事項をよくお読みになり、安全を御確認ください

Уверете се дека погоре споменатите мерки на претпазливост се добро разбрани

Asegúrese de que las precauciones de seguridad precedentes sean bien comprendidas

کاری بکنید کہ احتیاطهای بالا حتماً درک بشوند

ต้องแน่ใจว่า ข้อควรระวังเรื่องความปลอดภัยข้างต้น เป็นที่เข้าใจกันดี

Yukarda belirtilen güvenlik önlemlerinin anlaşıldığından emin olunuz

Xin kiểm chắc rằng những biện pháp làm an toàn kể trên được hiểu rõ

Crock-Pot's Safety Precautions

SAFETY PRECAUTIONS FOR YOUR MULTI COOKER.

- Do not plug in or switch on the unit without having the cooking pan inside the unit.
- Do not operate the unit on an inclined surface
- Use your unit well away from walls and curtains, and don't use in confined spaces.
- Check the pressure and steam release valve before use, and if clogged clean as necessary.
- Do not operate the unit without food or liquid in the cooking pan. Never exceed the maximum markings on the inside of the cooking pan, or maximum and minimum quantities stated in the recipes provided. Some foods expand during cooking, and it may result in developing excess pressure.
- Place the unit so that the pressure and steam release valve is positioned away from the body.
- Ensure the lid is locked before use. Brown/Sauté function does not require the lid to be used.
- Never use any lid except the lid provided with your Express Crock.
- Never place any part of the body including face, hands and arm over the Steam Release Valve. Steam can result in serious burns.
- Do not move or cover the unit whilst in operation
- Do not touch any metal surfaces of the unit while it is in use as they will be hot.
- **After pressure cooking, do not open the lid until the internal pressure has been released. If the lid will not turn to unlock, this is because there is pressure inside the unit. Do not force the lid open.**
- Do not cook more than 4 cups of dried beans/legumes with 8 cups of water. Cooking with more beans or water may result in the build up of excess pressure. Leave for ten minutes after cooking before releasing the pressure valve.
- Be careful when lifting and removing lid after cooking. Always tilt the lid away from you as steam is hot and can result in serious burns. Never place face over the unit.
- The pressure cooker operates under pressure. Incorrect use may result in injury.
- Use handles and oven mitts to move the unit, the cooking pan and the lid when hot.
- Unplug the unit when not in use and before cleaning. Allow the unit to cool before putting on or taking off parts to clean.
- Certain foods are not suited for pressure cooking as they can foam, froth, splatter and clog the pressure and steam release valve. Noodles, macaroni, spaghetti, cranberry, apple sauce, rhubarb, split peas, pearl barley, oatmeal and other cereals should not be cooked with pressure cook mode.
- Do not immerse the base of the unit in water or any other liquid.
- Do not use the cooking pan for food storage or place in the freezer.
- To prevent damage to the unit do not use alkaline cleaning agents when cleaning, use a soft cloth and a mild detergent.
- Do not operate the unit when placed directly onto a bench top. Place a heat proof mat or chopping board underneath to protect the surface.
- Avoid spillage on the connector.
- The heating element surface is subject to residual heating after use.
- Misuse may potentially cause injury or physical damage to the user.

Crock-Pot's Safety Precautions

Crock-Pot is very safety conscious when designing and manufacturing consumer products, but it is essential that the product user also exercise care when using an electrical appliance. Listed below are precautions which are essential for the safe use of an electrical appliance:

- Read carefully and save all the instructions provided with an appliance.
- Always turn the power off at the power outlet before you insert or remove a plug. Remove by grasping the plug - do not pull on the cord.
- Turn the power off and remove the plug when the appliance is not in use and before cleaning.
- Do not use your appliance with an extension cord unless this cord has been checked and tested by a qualified technician or service person.
- Always use your appliance from a power outlet of the voltage (A.C. only) marked on the appliance.
- This appliance is not intended for use by persons (including children) with reduced physical, sensory or mental capabilities, or lack of experience and knowledge, unless they have been given supervision or instruction concerning use of the appliance by a person responsible for their safety.
- Children should be supervised to ensure that they do not play with the appliance.
- The temperature of accessible surfaces may be high when the appliance is operating.
- Never leave an appliance unattended while in use.
- Do not use an appliance for any purpose other than its intended use.
- Do not place an appliance on or near a hot gas flame, electric element or on a heated oven.
- Do not place on top of any other appliance.
- Do not let the power cord of an appliance hang over the edge of a table or bench top or touch any hot surface.
- Do not operate any electrical appliance with a damaged cord or after the appliance has been damaged in any manner. If damage is suspected, return the appliance to the nearest Sunbeam Appointed Service Centre for examination, repair or adjustment.
- The appliance should be supplied through a residual current device (RCD) having a rated residual operating current not exceeding 30 mA.
- Do not immerse the appliance in water or any other liquid unless recommended.
- Appliances are not intended to be operated by means of an external timer or separate remote control system.
- This appliance is intended to be used in household and similar applications such as: staff kitchen areas in shops, offices and other working environments; farm houses; by clients in hotels, motels and other residential type environments; bed and breakfast type environments.
- The supply cord should be regularly examined for signs of damage and the appliance is not to be used if the cord is damaged.

If you have any concerns regarding the performance and use of your appliance, please visit www.crockpot.com or contact the Consumer Service Line.

Ensure the above safety precautions are understood.

Features of your Express Crock

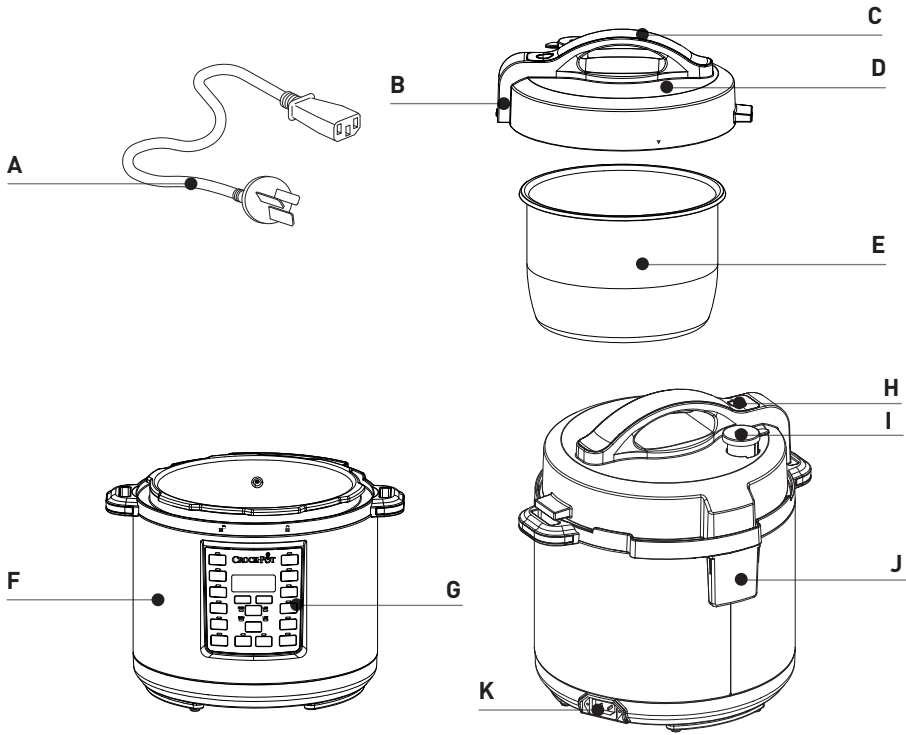

Control Panel

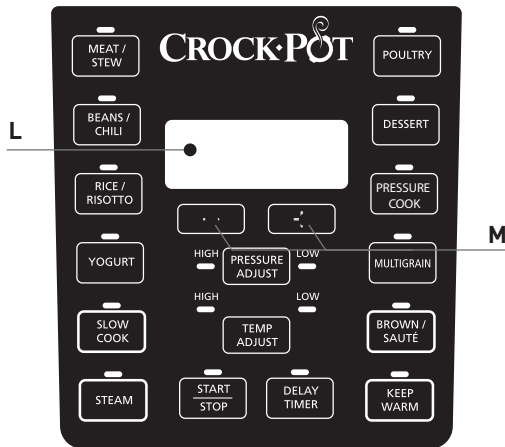

Underside of Lid

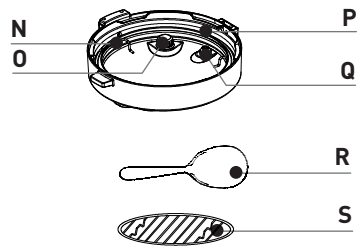

Features of your Express Crock

A. Power Cord

Removable power cord for added flexibility and ease of storage.

B. Lid Lock Pin

Acts as safety feature to ensure lid is secured properly before pressure starts to build during cooking.

C. Lid Handle

Comfortable and easy to grip handle allows removal of the lid and convenient way to carry the Express Crock.

D. Lid

Locks securely to the Heating Base during cooking. Cannot be unlocked until all pressure inside the unit has been released. Not required when using Brown/Sauté mode.

E. Cooking Pot

5.7L capacity easy clean non-stick coated cooking pot with volume markings on the inside as a handy capacity indicator.

F. Heating Base

The Cooking Pot is placed into the Heating Base during cooking. Helps maintain an even temperature throughout cooking process.

G. Control Panel

Use these buttons to select a cooking mode or a 1-touch meal then adjust the time, pressure and temperature options to suit.

H. Bobber Valve

The Express Crock will naturally release pressure through this valve at the end of the cooking cycle.

I. Steam Release Valve

Use this valve to quickly release pressure at the end of the cooking cycle. The extended finger tab on the cover is designed to keep the hand away from the top of the valve. Always use a kitchen utensil to turn this valve.

J. Condensation Collector

Collects excess condensation during the cooking and cooling process. Easy to remove and empty.

K. Power Cord Port

Connect the Power Cord here to use your Express Crock.

L. Display Screen

Shows the remaining cooking time.

M. Time Selection Buttons

Adjust the total cooking time or time delay using these buttons. Total time will be displayed on the Display Screen.

N. Gasket Fixing Ring

Holds the Sealing Gasket tightly in place during cooking.

O. Steam Release Valve Cover

Located on the underside of the lid to keep food in the Cooking Pot during quick pressure release through the Steam Release Valve. Ensure free from debris before cooking.

P. Sealing Gasket

Helps to create a tight seal between the Cooking Pot and Lid when building pressure. Always examine before each use for debris and deterioration.

Q. Bobber Valve

The Express Crock will naturally release pressure through this valve at the end of the cooking cycle.

R. Plastic Spoon

Use to serve cooked food from the Express Crock without damaging the Cooking Pot.

S. Steaming Rack

Use to elevate food off the bottom of the Cooking Pot during cooking. Used primarily for Dessert and Steam functions.

Before First Use of the Express Crock

Step 1. Remove Packaging

Ensure all packaging has been removed.

Step 2. Position Machine

Place the Heating Base facing you on a dry, level surface.

Step 3. Wash Parts

Wash the Cooking Pot and Lid and Condensation Collector in warm water using a mild detergent. Dry each part thoroughly before use.

Step 4. Assembly

Insert the Power Cord into the Power Cord Port and insert the Cooking Pot into the Heating Base.

Step 5. Lid Assembly

Place Lid upon Multi-Cooker and align ▼ with ■. To lock, twist counterclockwise, aligning ▼ with ■. To unlock, twist Lid clockwise and align ▼ with ■.

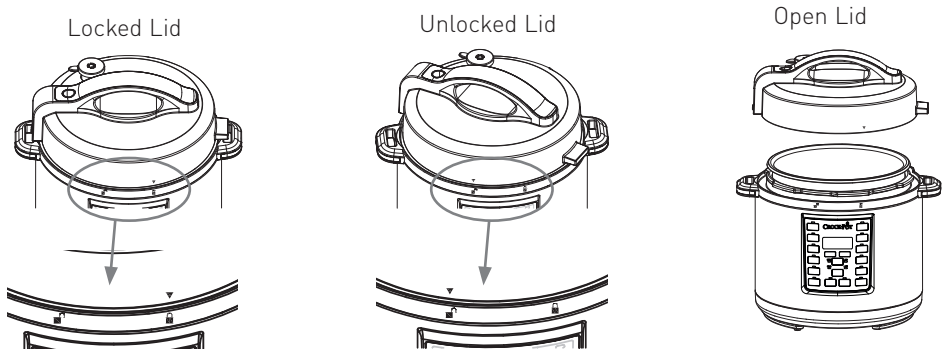

Step 6: Sealing Gasket

Remove the Lid by turning clockwise to unlock, aligning ▼ with ■. Remove the Sealing Gasket from the Lid and wash the gasket and the Lid in warm soapy water. Dry the Sealing Gasket and Lid thoroughly before reattaching the Sealing Gasket to the Lid. Ensure the Sealing Gasket is smoothly and securely in place in the gasket holder. If the Sealing Gasket is not in the correct position the Lid will not be able to form a seal and will not be able to gain pressure.



Things to know about your Express Crock

The Express Crock Multi-Cooker has been designed with safety in mind and has various safety measures.

- Pressure will not build if the Lid is not shut correctly and has not sealed.
- Ensure Lid is in the completely locked position and the ▼ is aligned with .
- Pressure will not build if the Steam Release Valve has not been switched to the Seal  position.
- Over filling may cause a risk of clogging the vent pipe and developing excess pressure.
- The gasket and the valves can be removed for cleaning. (See page 19).
- Once the pressure increases, the Lid cannot be opened. Safety sensors ensure the pressure remains within the set range.
- The Steam Release Valve has an extended finger tab, designed to keep the hand away from the top of the valve. Always use a kitchen utensil when operating this tab. See RELEASING PRESSURE Instructions on page 11.
- The pressure cooking functions require liquid to work. If the inside of the Cooking Pot does not have enough liquid, an notification will appear in the Display Screen. See NOTIFICATION CODES chart on page 22.
- At the end of cooking, the Lid cannot be unlocked until all the pressure is released. This can be done using the Natural Pressure Release Method or Quick Pressure Release Method, explained on page 11.



- The Time Selection Buttons (+ and -) are used to set the cooking time. To advance slowly, simply press the + or - button and release. To advance quickly, press and hold the + or - button. If you have passed the desired time, simply press the opposite arrow button to return to the desired time.

Note: The timer can be selected for all programs and can be changed at any time during cooking by pressing START/STOP and selecting a new function.

- The PRESSURE ADJUST button is used to select desired cooking pressure (HIGH or LOW). Each pre-set cooking setting automatically selects the optimum pressure for that selection, but it can be manually selected with this button (see the Cooking Guide on page 13 for available adjustments).
- The TEMP ADJUST button is used to select desired temperature (HIGH or LOW). The temperature may only be adjusted on the SLOW COOK, YOGURT, and BROWN/SAUTÉ functions (see the Cooking Guide on page 13 for available adjustments).
- The START/STOP button starts and stops a cooking function. It must be pressed to change from one cooking function to another after cooking has begun.
- The Display Screen shows how much longer the food needs to cook from the selected time in hours and minutes once the Multi-Cooker is preheated. While the Multi-Cooker is preheating, the display screen will show, "HEAT".

Using your Express Crock

Note: The Multi-Cooker beeps as each button is pressed.

- Add desired ingredients to Cooking Pot. Place Lid on top of Multi-Cooker and align ▼ with . To lock, twist counterclockwise, aligning ▼ with .
- Plug provided Power Cord into the Power Cord Port of the Multi-Cooker.
- Plug other end of the Power Cord into a wall power outlet.
- Select the cooking function you would like to use.
- The START/STOP button and the time on the screen will flash.
- Select the desired cook time by using the + and - buttons. Select the desired temperature using the TEMP ADJUST button (if applicable). Select the desired pressure using the PRESSURE ADJUST button. (Please refer to the Cooking Guide chart on page 13 for time and temperature recommendations.)
- Press the START/STOP button. For pressure cooking functions, the word "HEAT" will appear on the Display Screen during preheating time. Once the Multi-Cooker is preheated, the selected cooking time will appear on Display Screen.

Note: For Pressure Cooking functions, the average pre-heat time can vary depending on the volume and temperature of the food being cooked. This can range from 5-30 minutes.

- This Multi-Cooker allows you to delay the start of your cooking so that cooking finishes when you need it. See page 7 for instructions on the DELAY TIMER function.
- After the set cooking time has elapsed, the Multi-Cooker will beep again and will automatically switch to the KEEP WARM setting. The Display Screen will then change from the cook time to a new timer that will count up to 4:00 (4 hours) or until you press the START/STOP button. After 4 hours in the KEEP WARM setting, the Multi-Cooker will turn off.
- To end a cooking function at any time, press the START/STOP button.
- When finished, unplug the Multi-Cooker and wait for it to cool completely before attempting to clean.

CAUTION: The Cooking Pot and Heating Base will get very hot while using this Multi-Cooker. Do not touch hot surfaces. Always use pot holders or oven-mitts when using this Multi-Cooker. Always lift the Lid by tilting away from you to avoid the steam.

Time Delay Function

This Multi-Cooker allows you to delay the start of your cooking so that cooking finishes when you need it.

Note: The DELAY TIMER function is not available on the BROWN/SAUTÉ, KEEP WARM, or YOGURT settings.

Note: Do not use the DELAY TIMER function when the recipe has perishable ingredients such as meat, fish, eggs, or dairy, as these may spoil.

- Adjust the Multi-Cooker settings using the instructions on pages 9-17.
- After setting the cooking time, press the DELAY TIMER button. The DELAY TIMER and START/STOP buttons will flash, and "0:30" will flash on the Display Screen, to indicate the Multi-Cooker is being programmed on the delay setting.
- Press the + and - buttons until you reach the number of hours and minutes you want the cooking process to be delayed [i.e., set the amount of time you wish to delay the cooking cycle]. The maximum delay is 4 hours.
- Press START/STOP button to begin the delay feature. The timer and DELAY TIMER button will stop flashing, while the START/STOP button will continue flashing. This will indicate that the Multi-Cooker has been set on the DELAY TIMER setting. The Display Screen will countdown the delay time until 0:00 is reached. When 0:00 is reached, the DELAY TIMER light will turn off and the START/STOP light will stop flashing to show that time delay has finished. The word "HEAT" will appear on the display screen until the Multi-Cooker is fully pressurized. When the selected pressure has been reached, the timer will start counting down.

Example:

It's 4pm and you want to have a soup cooked and ready in 2 hours' time for dinner at 6pm. You want to set the machine now so you are free to do other things.

The Pressure Cook function (if unchanged) will cook for 30 minutes at HIGH pressure.

Time to gain pressure varies according to humidity and water temperature, but let's assume it takes 15 minutes to gain pressure. Therefore total time is 45 minutes. To have the soup ready by 6pm, you will need to delay the start of your cooking by approximately 1 hour and 15 minutes.

1. Press PRESSURE COOK
2. The Display Screen will flash "0:30"
3. Press the DELAY TIMER button and set for "1:15"
4. Press START/STOP

Cooking Pot Markings

Inside the removable Cooking Pot are markings to guide the fill level of the Cooking Pot. The word MAX indicates the maximum fill line.

The 1/3, 1/2, and 2/3 markings are handy guides to use in your recipes.

CAUTION: Never load the Cooking Pot above the maximum ingredient level line marked MAX on the inside of the Cooking Pot.

Foods that expand during cooking (e.g. rice) should never go above the 1/2 mark.

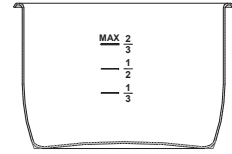

Note: The Multi-Cooker cannot pressure cook without liquid. Ensure a minimum of 250ml of liquid is used inside the removable Cooking Pot.

Pressure Cooking

Pressure cooking is an ideal way to create quick, flavorful meals. Pressure cooking is a method of cooking food in liquid (water, stock, wine, etc.) in a sealed Cooking Pot. The sealed Multi-Cooker retains steam and builds pressure, raising the temperature of the liquid inside the pot above boiling point. The increased temperature of the liquid and the steam results in reduced cooking times.

HIGH Pressure Setting is 6.5 - 10 PSI (45 - 70 kPa). It is suitable for a wide range of foods.

LOW Pressure Setting is 3.3 - 6.5 PSI (23 - 45 kPa). It is more suited to delicate foods like chicken fillet, fish and some vegetables.

KEEP WARM Setting: When cooking time is completed, the Multi-Cooker automatically switches to the KEEP WARM setting to prevent overcooking and to keep your cooked food warm until serving - perfect for busy families, those on the run and those who need flexible meal times. This setting is not hot enough to cook and should only be used to keep warm, cooked food for serving.

Ideal Meals to Pressure Cook: Soups, stocks, casseroles, sauces (e.g. pasta sauces), meat, rice, firm vegetables (beetroot, potatoes) and desserts (e.g., pudding).

Capacity: Never fill the Cooking Pot above the MAX line. Foods that expand during cooking should never go above the 1/2 mark. The Multi-Cooker cannot pressure cook without liquid. Ensure a minimum of 250ml of liquid is used inside the removable Cooking Pot.

Note: There are 8 functions which use pressure to cook. These are Meat/Stew, Beans/Chili, Rice/Risotto, Poultry, Dessert, Multigrain, Pressure Cook and Steam.

IMPORTANT: Do not cook more than 4 cups of dried beans/legumes with 8 cups of water. Cooking with more beans or water than this may result in the build up of excess pressure. Wait at least 10 minutes after cooking before releasing the pressure valve.

Using the Pressure Cooking functions

Place the Multi-Cooker on a flat, level surface. Place Cooking Pot inside Heating Base. Plug the Multi-Cooker into a wall outlet. The Multi-Cooker will beep, and the Display Screen will illuminate with four dashes (- - - -).

- Place your food and liquid inside the removable Cooking Pot.
- Place the Lid onto the Multi-Cooker and align ▼ with ■. To lock, rotate counterclockwise to the LOCKED 🔒 position.
- Using the finger tab, rotate the Steam Release Valve to the "Seal" position.
- Select the desired cooking function
- Adjust the cooking time and pressure if necessary.

Note: See the Cooking Guide on page 13 to find the possible time and pressure adjustments.

- Once you have made the desired adjustments, if any, press START/STOP.
- The Multi-Cooker needs to gain pressure before pressure cooking can begin. When the Multi-Cooker is gaining pressure, "HEAT" will appear on the Display Screen and the time will not count down. The amount of time the Multi-Cooker takes to gain pressure varies according to humidity and water temperature, but average pressurization time is 5-30 minutes. When pressure has been reached, "HEAT" will disappear on the Display Screen, and the time will begin to count down.
- After the set cooking time has elapsed, the Multi-Cooker will beep and will automatically switch to the KEEP WARM setting. The Display Screen will therefore change from the cook time to a new timer that will count up to 4:00 (4 hours) or until you press the START/STOP button. After 4 hours in the KEEP WARM setting, the Multi-Cooker will go into stand-by mode, and the Display Screen will illuminate with four dashes (----).

TIP:

- The pressure cooking settings are in the Cooking Guide table on page 13.
- If the lid is not shut correctly or if the Steam Release Valve is not in the "Seal" position, the Multi-Cooker cannot gain pressure and an Notification message will appear in the Display Screen. Ensure that the Sealing Gasket is placed evenly in the lid. See the Notification Codes chart on page 22.
- It is common for some steam to release through the Bobber Valve during the cooking cycle. This is part of normal operation of the unit.

Note: The Multi-Cooker cannot pressure cook without liquid. Ensure a minimum of 250ml of liquid is used inside the removable Cooking Pot.

Caution: During cooking, steam will build up in the Multi-Cooker, so when lifting the lid use an oven glove to protect your hands.

Note: Foam may naturally form when pressure cooking beans or legumes. Add a small amount of oil to the water before cooking to reduce this.

Releasing Pressure at the End of Cooking

Natural Pressure Release Method:

After cooking cycle is complete, let Multi-Cooker naturally release pressure through the Bobber Valve. Unit will gradually cool down on its own. Wait at least 10 minutes after cooking has completed. If using a higher volume of food and liquid, this can take up to 20 minutes. And then, using a kitchen utensil, gradually flick the tab on the Steam Release Valve to the "Release" position (see Figure 4). Do not place any part of your hand or body over the steam outlet on top of the valve, as steam is very hot and can scald skin. The pressure has been released when steam is no longer escaping from the valve and the Lid opens freely with minimal force. Only then is it safe to remove the Lid and serve food.

Quick Pressure release method should be used with caution:

Using a kitchen utensil, gradually flick the tab on the Steam Release Valve to the "Release" setting (see Figure 4). Steam will release rapidly from the Steam Release Valve. Do not place any part of your hand or body over the steam outlet on the top of the valve, as steam is very hot and can scald skin. Use this method with caution when cooking liquid ingredients such as casseroles, soups, stocks, beans and pulses. Never use this method when cooking rice, as rice tends to be very delicate. The pressure has been released when steam is no longer escaping from the valve and the Lid opens freely with minimal force. Only then is it safe to remove the Lid and serve food.

CAUTION: Do not force the Lid to open. If it does not open easily this means that the Multi-Cooker is still under pressure.

CAUTION: During cooking, steam will build up in the Multi-Cooker, so when lifting the Lid use a kitchen glove or mitt to protect your hand.

Pressure Release Valve
Valve CLOSED ("Seal")

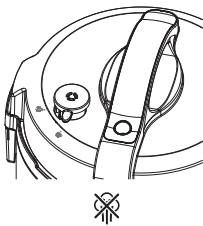

Valve OPEN ("Release")

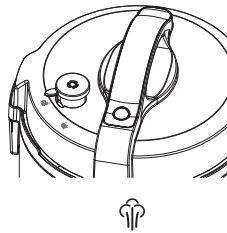
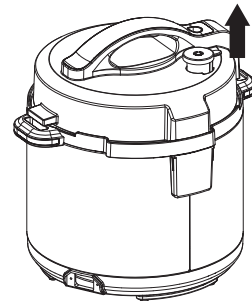

Figure 4

Valve REMOVE



Slow Cooking

LOW Setting: This is suitable for simmering and slow cooking. Recommended cooking times in LOW are from 6 to 8 hours.

HIGH Setting: This is for faster cooking. Recommended cooking times in HIGH are from 2 to 4 hours.

KEEP WARM Setting: When cooking time is completed, the Multi-Cooker automatically switches to the KEEP WARM setting to prevent overcooking and to keep your cooked

food warm until serving - perfect for busy families, those on the run and those who need flexible meal times. This setting is not hot enough to cook and should only be used to keep hot, cooked food warm for serving.

Note: When slow cooking, the ideal fill level for your ingredients is between the 1/2 and 2/3 marks. Never fill the Cooking Pot above the MAX line.

Using the SLOW COOK Function

The SLOW COOK function does not use pressure in the cooking process, but some pressure can build inside the unit during cooking. When using this function, ensure the Steam Release Valve is in the "Release" position. This function will cook similarly to standard slow cookers, using lower temperatures and longer cooking times to achieve tender, flavorful meals.

Place the Multi-Cooker on a flat, level surface.

Place Cooking Pot inside Heating Base. Plug the Multi-Cooker into a wall outlet. The Multi-Cooker will beep, and the Display Screen will illuminate with four dashes (- - - -).

1. Place your food and liquid inside the removable Cooking Pot.
2. Place the Lid onto the Multi-Cooker and align ▼ with ■. To lock, rotate counterclockwise to the LOCKED 🔒 position.
3. Using the finger tab, rotate the Steam Release Valve to the "Release" position.

Note: Although this setting will not use pressure in the cooking process, some pressure can build inside the unit during cooking. This is why it's important to keep the Steam Release Valve in the "Release" position.

4. Press the SLOW COOK button and adjust the time and temperature as needed.

Note: See the Cooking Guide on page 13 to find the possible time and temperature adjustments.

5. Press START/STOP. The time will begin to count down.
6. After the set cooking time has elapsed, the Multi-Cooker will beep and will automatically switch to the KEEP WARM setting. The Display Screen will therefore change from the cook time to a new timer that will count up to 4:00 (4 hours) or until you press the START/STOP button. After 4 hours in the KEEP WARM setting, the Multi-Cooker will turn off.

TIP: The SLOW COOK settings are in the Cooking Guide on page 13.

Caution: During slow cooking, steam may build up in the Multi-Cooker, so when lifting the Lid use a kitchen glove or mitt to protect your hand.

Cooking Guide

Cooking Function	Default Setting	Pressure Adjustments	Temperature Adjustments	Cook Time Range
SLOW COOK	High temp / 4 hours	N/A	Low-High	30 minutes – 20 hours
STEAM	High pressure / 10 minutes	Low-High	N/A	3 minutes - 1 hour
BROWN/ SAUTE	High temp / 30 minutes	N/A	Low-High	5 minutes - 30 minutes
KEEP WARM	Warm temp / 4 hours	N/A	Warm	30 minutes – 4 hours
MEAT/STEW	High pressure / 35 minutes	Low-High	N/A	5 minutes - 2 hours
BEANS/ CHILI	High pressure / 20 minutes	Low-High	N/A	5 minutes – 2 hours
RICE/ RISOTTO	Low pressure / 12 minutes	Low-High	N/A	6 minutes - 30 minutes
YOGURT	Low temp / 8 hours	N/A	Low-High	Low: 6 hours - 12 hours High: N/A
POULTRY	High pressure / 15 minutes	Low-High	N/A	15 minutes – 2 hours
DESSERT	Low pressure / 10 minutes	Low-High	N/A	5 minutes – 2 hours
MULTIGRAIN	High pressure / 40 minutes	Low-High	N/A	1 minute – 2 hours
PRESSURE COOK	High pressure / 30 minutes	Low-High	N/A	5 minutes - 2 hours

Steaming

The STEAM function is perfect for gently steaming fish and vegetables. It is pre-programmed to use the HIGH pressure cooking setting. When steaming, use the Steaming Rack.

Capacity:

When the Multi-Cooker is used with the STEAM function, the maximum capacity of liquid should be just under the rack wires, so that the liquid is not touching the food.

Note: The unit cannot pressure cook without liquid. Ensure a minimum of 250ml of liquid is used inside the removable Cooking Pot.

Using the STEAM Function

- Place the Multi-Cooker on a flat, level surface.
- Place Cooking Pot inside Heating Base. Plug the Multi-Cooker into a wall outlet. The Multi-Cooker will beep, and the Display Screen will illuminate with four dashes (- - - -).
- Add 250ml of water to the bottom of the removable Cooking Pot and insert the cooking rack. Ensure water is just under the wires of the rack so that food is not touching water.
- Place your food on the cooking rack.
- Place the Lid on and lock by rotating counterclockwise to the LOCKED  position.
- Using the finger tab, flick the Steam Release Valve to the "Seal" position.
- Press the STEAM button and adjust the time and pressure as needed.
Note: See the Cooking Guide on page 13 to find the possible time and pressure adjustments.
- Once you have made the desired adjustments, if any, press START/STOP.
- The Multi-Cooker needs to gain pressure before pressure cooking can begin. When the Multi-Cooker is gaining pressure, "HEAt" will appear on the Display Screen and the time will not count down. When pressure has been reached, "HEAt" will disappear on the Display Screen, and the time will begin to count down.
- After the set cooking time has elapsed, the Multi-Cooker will beep and will automatically switch to the KEEP WARM setting. The Display Screen will therefore change from the cook time to a new timer that will count up to 4:00 (4 hours) or until you press the START/STOP button. After 4 hours in the KEEP WARM setting, the Multi-Cooker will turn off.

TIP: See the Steaming Chart on page 15.

CAUTION: During cooking, steam will build up in the Multi-Cooker, so when lifting the Lid use a kitchen glove or mitt to protect your hand.

Steaming Chart

Food	Amount	Amount of water	Pre-prep	Cooking Time, minutes
Asparagus	250g	400ml	trim woody ends	2
Broccoli	300g	400ml	trim stalks	2
Brussel Sprouts	400g	400ml	peel outer leaves, leave whole	4
Butternut Squash	1 whole, 900g-1kg	400ml	cut in half, remove seeds, slice into 6	7
Carrots	500g	400ml	sliced into 1 cm rounds	5
Carrots and Swede	600g	400ml	peel and cut into similar sized pieces	6
Cauliflower	500g	400ml	cut into 5cm florets	3
Corn on the Cob	2	400ml	remove any outer leaves	3
Frozen Chunky Vegetables	500g	400ml	cook from frozen	3
Green cabbage	1 whole	400ml	cut into quarters	4
Leeks	500g	400ml	trim ends and cut into 2 cm rounds	4
New Potatoes	750g	400ml	leave whole	8
Sweet Potatoes	900g - 1kg	400ml	peel and cut into large chunks	5
White potatoes, ideal for mash	900g - 1kg	400ml	peel and cut into large chunks	9
Basmati Rice	400g (2 cups)	600ml	rinse rice before use	6
Brown Rice	400g (2 cups)	400ml	rinse rice before use	22
Eggs	6	400ml	whole in shell	7
Chicken fillet	2-4 fillets	400ml	season before cooking	8
Asparagus	2-4 fillets	400ml	season before cooking	3

Using the BROWN/SAUTÉ Function

This setting does not cook under pressure. It works similarly to standard cooking, requiring dry heat, and therefore does not need the Lid.

Important: Do not use the Lid with this function.

Place the Multi-Cooker on a flat, level surface.

Place Cooking Pot inside Heating Base. Plug the Multi-Cooker into a wall outlet. The Multi-Cooker will beep, and the Display Screen will illuminate with four dashes (- - - -).

- Select the BROWN/SAUTÉ function and adjust the time and temperature if necessary, using the + and - buttons.
- Press START/STOP.
- When the Multi-Cooker is pre-heating, "HEAT" will appear on the Display Screen. When the temperature has been reached, the timer will start counting down. Using plastic tongs, carefully add your food to the hot pot.

BROWN/SAUTÉ can be used for each of the following:

- A. Brown (sear) meats for casseroles and soups. Browning meat prior to pressure cooking and slow cooking not only gives your food great color, but it also seals in the juices and flavors and keeps the meat tender.
- B. Sauté onions or mirepoix (mixture of chopped onion, carrot, and celery), among many other foods, often used in pressure cooker and slow cooker recipes. Sautéing onions allows caramelization which contributes to flavor and color in the end dish.

Capacity:

When the Multi-Cooker is used to brown or sauté it may be best to cook in batches to ensure the food is evenly cooked.

Rice Cooking

When cooking rice, use the RICE/RISOTTO function. This is suitable for all types of rice, including white and/or brown rice.

The RICE/RISOTTO function cooks under pressure for faster cooking.

Capacity:

Since rice expands during cooking, do not fill Cooking Pot above the 1/2 mark when using the RICE/RISOTTO function.

Using the RICE/RISOTTO Function

Place the Multi-Cooker on a flat, level surface.

Place Cooking Pot inside Heating Base. Plug the Multi-Cooker into a wall outlet. The Multi-Cooker will beep, and the Display Screen will illuminate with four dashes (- - - -).

- Measure the desired quantity of rice.

Note: 1 cup uncooked white rice = 2 cups of cooked white rice (approximately). 1 cup uncooked brown rice = 2 cups cooked brown rice (approximately).

- Place the measured rice in a strainer and wash rice thoroughly under cold water. Wash until the water runs clear. This removes excess starch which helps to achieve fluffier rice, and prevents rice grains sticking to the Cooking Pot. Rinsing the rice reduces the build-up of starchy water and bubbles that sometimes form around the Valve Cover and Lid, which can cause spitting from the Steam Release Valve.
- Ensure the Cooking Pot is clean and dry before placing it inside the Heating Base.
- Place the washed rice in the Cooking Pot. Add the quantity of water needed for your recipe (Standard ratio -- 1 cup of uncooked rice : 1.5 cups of water). Ensure that a minimum of 250ml of liquid is placed inside the removable Cooking Pot.
- Place the Lid on and lock by rotating counterclockwise to the LOCKED  position.
- Using the finger tab, flick the Steam Release Valve to the "Seal" position.
- Press the RICE/RISOTTO button and adjust the time and pressure as needed.

Note: See the Cooking Guide on page 13 to find the possible time and pressure adjustments.

- Once you have made the desired adjustments, if any, press START/STOP.

- The Multi-Cooker needs to gain pressure before pressure cooking can begin. When the Multi-Cooker is gaining pressure, "HEAT" will appear on the Display Screen and the time will not count down. When pressure has been reached, "HEAT" will disappear on the Display Screen, and the time will begin to count down.
- After the set cooking time has elapsed, the Multi-Cooker will beep and will automatically switch to the KEEP WARM setting. The Display Screen will therefore change from the cook time to a new timer that will count up to 4:00 (4 hours) or until you press the START/STOP button. After 4 hours in the KEEP WARM setting, the Multi-Cooker will turn off.

Note: Do not keep rice in the pot for extended periods of time on the KEEP WARM setting, as the rice will become dry and the quality will deteriorate. Use the supplied plastic spoon to stir and serve the rice. Do not use metal utensils, as these will scratch the non-stick coating.

Note: As rice grains can be delicate, at the end of cooking wait until the pressure releases naturally. Do not use the Quick Pressure Release Method (see page 11 for instructions on the Natural Pressure Release Method).

Note: Standard ratio for cooking rice -- 1 cup of uncooked rice : 1.5 cups of water.

Caution: During cooking, steam will build up in the Multi-Cooker, so when lifting the Lid use a kitchen glove or mitt to protect your hand.

To Change a Setting

It's easy to switch functions during cooking. Press the START/STOP button and then select the new desired cooking function. A new timer will flash on the Display Screen, and the selected function will also flash. Select the desired time, pressure, and/or temperature. Press the START/STOP button and the new function will begin preheating.

To Change the Cooking Time

You can change the cooking time before cooking begins by pressing the + and - buttons before pressing START/STOP. Press and release to change slowly. Press and hold to change time quickly. If you pass the desired temperature or time, press the opposite button.

To Change the Pressure

You can change the pressure on certain pre-set functions before cooking begins by pressing the PRESSURE ADJUST button before pressing START/STOP.

To Change the Temperature

You can change the temperature on certain functions before cooking begins by pressing the TEMP ADJUST button before pressing START/STOP.

Care & Cleaning

Cleaning should only be carried out when the Express Multi-Cooker is cool and unplugged. Allow the Multi-Cooker to completely cool before cleaning. Do not use the removable Cooking Pot on the stovetop, inside a microwave oven or inside an oven. Use the pot only inside the Express Multi-Cooker Heating Base. Wash the Sealing Gasket and Lid by hand in warm, soapy water. Dry all parts thoroughly.

Cooking Pot

When removing the Cooking Pot from the Heating Base, always use two hands and lift directly upward. Failure to do so may result in scratching the outside of the Cooking Pot (see figure 5).

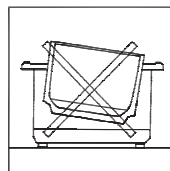
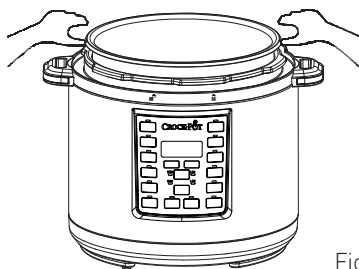

Figure 5

Care & Cleaning

If food sticks or burns to the surface of the Cooking Pot, then fill it with hot soapy water and let it soak before cleaning. Use a rubber or nylon spatula to remove stubborn residue. If scouring is necessary, use a non-abrasive cleaner and a nylon scouring pad or brush. Hand wash the Cooking Pot with mild detergent in warm water to protect the inner coating.

Note: Cooking Pot is dishwasher safe however the outer aluminium finish may discolour over time. This will not affect cooking performance.

If white spots form on surface of Cooking Pot, then soak it in a solution of vinegar or lemon juice and warm water for 30 minutes. Rinse and dry.

Note: Never use metal utensils or cleaning devices on the Cooking Pot, as this may result in scratching and damaging the non-stick coating.

Exterior

Wipe the exterior of the Heating Base with a damp cloth and polish dry. DO NOT use harsh abrasives, scourers or chemicals, as these will damage the surfaces. To prevent damage to the Multi-Cooker do not use alkaline cleaning agents when cleaning. Only use a soft cloth and mild detergent. Never immerse the heating base in water or any other liquid.

Condensation Collector

Empty any collected water from the Condensation Collector after each use. Wash in warm, soapy water.

Lid and Sealing Gasket

Always examine the gasket before each use. The silicon Sealing Gasket on the inside of your Multi-Cooker Lid may deteriorate over time. Remove Sealing Gasket for cleaning as needed. Hand clean using warm, soapy water, dry thoroughly, and replace Sealing Gasket in Lid before use. Leave the Lid upturned for storage, as this will also extend the life of the gasket. Sealing Gasket may need to be replaced every 1 – 2 years depending on regular use. Contact Crock-Pot® customer service to order replacement parts.

Steam Release Valve

Ensure the Steam Release Valve is clear from debris before you begin using the Multi-Cooker. Remove the valve and gently clean. Ensure it is completely dry before replacing.

Steam Release Valve Cover

The Steam Release Valve Cover is on the underside of the Lid. Ensure it is clear from debris before you begin using the Multi-Cooker. To clean, carefully pull the cover off and clean using warm, soapy water. Press the cover back into its place after cleaning is complete.

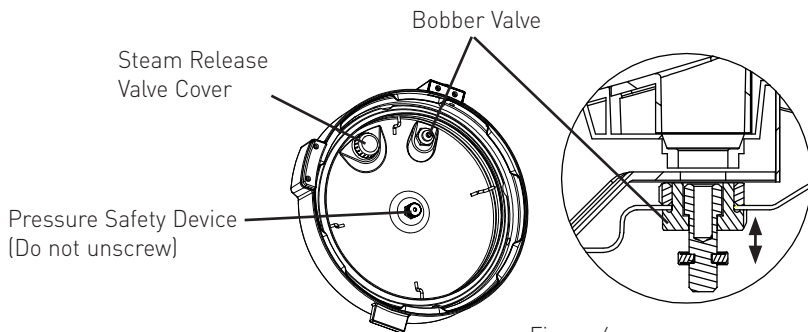

Figure 6
Underside of Lid

Care & Cleaning

Bobber Valve

Gently press the valve up and down 2-3 times and ensure it is clear from debris before you begin using the Multi-Cooker.

Lid Lock Pin

Gently press the pin and ensure it is clear from debris before you begin using the Multi-Cooker.





Note: Condensation may collect inside the Heating Base under the removable Cooking Pot. This is normal. Allow to cool, and then dry using kitchen cloth.

Note: Always make sure that each component (pot, valves, gasket, etc.) is completely dry before you put back into the Multi-Cooker.

Troubleshooting

Subject	Question	Solution
Power	My Multi-Cooker will not turn on	Make sure outlet is functioning properly
		Check that the Multi-Cooker is plugged in
		Call Customer Service on 1300 881 861 (Aus), 0800 786 232 (NZ)
Doneness of food	My food was undercooked	Make sure you selected the proper cooking setting
		Make sure the Lid is properly placed and locked, and that Steam Release Valve in "Seal" (closed) position.
		Check the recipe to see that the proper pressure, temperature, and time selection were made
		Be sure the power was not interrupted
	Make sure the Cooking Pot has enough liquid to create desired steam and build pressure. Minimum of 250ml of liquid should be used when pressure cooking. Never fill over the "MAX" line.	
My food was overcooked	Make sure the Cooking Pot was at least ½ full	
	Check that the proper pressure, temperature, and time were selected	
Programming	Can I set a time for the Brown/Sauté program?	Because sautéing is a function that generally requires your full attention this may not be necessary. However, if desired a time can be selected.
	Can I change the cooking function, time or temperature once the food is cooking?	Yes, to change the cooking function, press START/STOP and select a new cooking function. Change the time and temperature as required for the food. Press START/STOP again. The time and temperature can be changed at any time.
Cooking	Can the Cooking Pot and Lid be used on top of the stove or in the oven?	The Cooking Pot and Lid are not oven safe. Neither can be used on the stove or in the oven.
	I stopped the cooking process and changed pressure settings, and now the Multi-Cooker is preheating again.	If a cooking cycle is stopped and a new one is started, the Multi-Cooker may display "HEAt" until the new pressure is achieved.
Steam	Steam is leaking out of the Multi-Cooker	<ul style="list-style-type: none"> It is normal for a small amount of steam to come out of the Bobber Valve before the Multi-Cooker is pressurised. If steam is coming out from the perimeter of the Lid, the Lid has not been closed and locked completely or too much water has been added to the cooking pot.
Lid	I am having trouble removing the Lid.	There is a safety feature to keep Lid from being removed while the Multi-Cooker is under pressure. Please make sure to de-pressurize the unit by rotating the Steam Release Valve into the "Release" (open) position. Refer to Releasing Pressure section for further instructions.

Notification Codes

Error	Solution
"CLOSE LID" blinking light	Ensure that the Lid is closed completely and in the LOCKED  position, aligning  with  .
Display "E1"	The Multi-Cooker will stop the cooking cycle. Unplug Multi-Cooker and contact service center.
Display "E2"	The Multi-Cooker will stop the cooking cycle. Unplug Multi-Cooker and contact service center.
Display "E3"	The Multi-Cooker will stop the cooking cycle. Unplug Multi-Cooker, and allow to cool down completely. Once Multi-Cooker has cooled down, check all parts of the Lid (See page 19). Turn Lid to LOCKED  position. Ensure Steam Release Valve is in "Seal" (closed) position. If this notification code occurs again, unplug Multi-Cooker and contact service center.
Display "E4"	The Multi-Cooker will stop the cooking cycle. Unplug Multi-Cooker, and allow to cool down completely. Once Multi-Cooker has cooled down, check Cooking Pot to ensure there is enough liquid inside. Add more liquid if necessary (Minimum 250ml). Ensure no steam is coming out of Cooking Pot before placing Lid back on Multi-Cooker. Turn Lid to LOCKED  position. Ensure Steam Release Valve is in "Seal" (closed) position. Select a pressure cooking function, and then press START/STOP.
Display "E5"	The Multi-Cooker will stop the cooking cycle. Unplug Multi-Cooker and allow to cool. Once it is cooled down, remove the Lid and check the Cooking Pot. Do not use the Lid when using the BROWN/SAUTÉ function. When using the SLOW COOK function, make sure that the Steam Release Valve is in the "Release" (open) position before starting the cooking cycle.
Display "E6"	The Multi-Cooker will stop the cooking cycle. Unplug Multi-Cooker and allow to cool. Once it is cooled down, remove the Lid and check the Cooking Pot. Add liquid as necessary. Ensure a minimum of 250ml of liquid is used inside the removable Cooking Pot. If using a pressure cooking function, ensure that the Steam Release Valve is in the "Seal" (closed) position.

Hints & Tips

With your Express Crock you can create a large variety of delicious meals, snacks and desserts. Various foods take different times to cook perfectly, so sometimes it may take some trial and error to get the cooking times right for you.

- Please refer to your Express Crock user guide when using your Multi-Cooker.
- Never fill the Cooking Pot past the MAX line.
- Do not leave Multi-Cooker plugged in when not in use.
- Make sure Multi-Cooker is kept away from cabinets and walls when in use.

- The Cooking Pot is designed to be used only in this Multi-Cooker. Do not use on stovetop, in microwave, or in oven.
- The provided Steaming Rack is designed to be used in this Multi-Cooker. It should not damage the surface of the Cooking Pot.
- When removing the Lid, use a pot holder to grasp the Lid Handle and lift away from your body to allow steam to escape.
- Always place a trivet or pot holder under the Cooking Pot if it is removed from the Heating Base.

Hints & Tips For Slow Cooking

- If you are slow cooking, you can use the BROWN/SAUTÉ function first, which allows you to sear meats and vegetables at the beginning but also allows you to thicken sauces and make gravies at the end. Browning meat prior to slow cooking not only gives your food great color, but it also seals in the juices and flavors and keeps the meat tender.
- To thicken a casserole at the end of cooking, use the BROWN/SAUTÉ function and stir a small amount of corn flour with water. Allow to simmer, stirring until thickened.
- It is not uncommon for meat to cook faster than root vegetables. It is for this reason that we recommend chopping all vegetables to a similar small size. Meat can be cut into larger chunks because if it is cut too small, it will break up once cooked and tenderized.
- When using the SLOW COOK function, the Multi-Cooker does not recover lost heat quickly, so only lift the Lid if necessary or if instructed to do so in the recipe. It's a good idea to monitor your slow cooking results throughout the cooking cycle by quickly removing the Lid and checking, then quickly replacing the Lid. Different cuts and thickness of meats and vegetables can vary cooking times.
- When using the SLOW COOK function, make sure the Steam Release Valve is in the "Release" (open) position.
- Slow Cooking reduces evaporation, resulting in the flavors and juices being maintained. Keep this in mind when creating your own recipes, as you may not require as much liquid as you would when using other cooking methods.

Temperature	Temperature Suggestions	Recipes Ideas
High	Use this setting for recipes that require shorter cooking times, generally 4-6 hours.	Ideal for sauces, chili, potato dishes, cheese dishes, chicken wings and meatballs in sauce
Low	Use this setting for recipes that require longer cook times. This setting is used for recipes that usually require cooking for more than 8 hours. Perfect for less tender cuts of meats.	Ideal for less tender cuts of meat, braised meats, dried beans, soups and stews

12 Month Replacement Guarantee

This product is covered by a 12 month replacement or repair warranty, which is in addition to your rights under the Australian Consumer Law (if your product was purchased in Australia) or New Zealand Consumer Guarantees Act (if your product was purchased in New Zealand).

Upon receipt of your claim, Sunbeam will seek to resolve your difficulties or, if the product is defective, advise you on how to obtain a replacement or refund.

To assist us in managing warranty claims, we recommend you register your product as soon as practicable after purchase by creating a MySunbeam account on our website and uploading a copy of your original receipt.

In order to make a claim under our warranty, you must have the original proof of purchase documentation for the product and present it when requested (if not already uploaded to our website).

Should your product develop any defect within 12 months of purchase because of faulty materials or workmanship, we will replace or repair it, at our discretion, free of charge. A product presented for repair may be replaced by a refurbished product of the same type rather than being repaired. Refurbished parts may be used to repair the product.

Our replacement or repair warranty only applies where a defect arises as a result of faulty material or workmanship during the warranty period. Your warranty does not cover misuse or negligent handling (including damage caused by failing to use the product in accordance with this instruction booklet), accidental damage, or normal wear and tear.

Your warranty does not:

- cover freight or any other costs incurred in making a claim, consumable items, accessories that by their nature and limited lifespan require periodic renewal (such as filters and seals) or any consequential loss or damage; or

- cover damage caused by:
 - power surges, power dips, voltage supply problems, or use of the product on incorrect voltage;

- servicing or modification of the product other than by Sunbeam or an authorised Sunbeam service centre;
- use of the product with other accessories, attachments, product supplies, parts or devices that do not conform to Sunbeam specifications; or
- exposure of the product to abnormally corrosive conditions; or

- extend beyond 3 months if the product is used in commercial, industrial, educational or rental applications.

The benefits given to you by our warranty are in addition to other rights and remedies under law in relation to the product.

In Australia our goods come with guarantees that cannot be excluded under the Australian Consumer Law. You are entitled to a replacement or refund for a major failure and for compensation for any other foreseeable loss or damage. You are also entitled to have the goods repaired or replaced if the goods fail to be of acceptable quality and the failure does not amount to a major failure.

Our goods also come with guarantees that cannot be excluded under the New Zealand Consumer Guarantees Act.

If your warranty claim is not accepted, we will inform you and if requested to do so by you, repair the product provided you pay the usual charges for such repair. You will also be responsible for all freight and other costs.

Should your product require repair or service after the warranty period, contact your nearest Sunbeam service centre. For a complete list of Sunbeam's service centres, visit our website or call our customer service line for advice on 1300 881 861 in Australia, or 0800 786 232 in New Zealand.

Should you experience any difficulties with your product during the warranty period, please contact our customer service line for advice on 1300 881 861 in Australia, or 0800 786 232 in New Zealand.

Australia

www.crockpot.com.au
1300 881 861
Units 5 & 6,
13 Lord Street,
Botany NSW 2019
Australia

New Zealand

www.crockpot.co.nz
0800 786 232
Level 6, Building 5,
Central Park,
660-670 Great South Road,
Greenlane, Auckland
New Zealand

CROCK·POT®

Need help with your appliance?

Contact our Customer Care Team or visit our website for information and tips on getting the most from your appliance.

AUSTRALIA

Visit: www.crockpot.com.au
Phone: 1300 881 861
Mail: Units 5 & 6, 13 Lord Street,
Botany NSW 2019

NEW ZEALAND

Visit: www.crockpot.co.nz
Phone: 0800 786 232
Mail: Level 6, Building 5, Central Park,
660–670 Great South Road,
Greenlane, Auckland



— APPROVED BY —



Sunbeam Corporation PTY LTD | ACN 000 006 771
Crock-Pot and Sunbeam are registered trade marks.

Due to continued product improvements,
product illustrations and photographs in this User Guide
may differ slightly from the actual product.