



# FoodSaver®

by *Sunbeam*

## Home Vacuum Packaging System Lock & Seal

User Guide

VS4500



# Contents

Important Safeguards	1
Vacuum Packaging Tips	2
VS4500 FoodSaver® Lock & Seal	3
Using your FoodSaver®	5
Make a bag with FoodSaver® rolls	
Vacuum seal with FoodSaver® bags	
Vacuum seal with FoodSaver® accessories	
Food Preparation & Safety Tips	9
Care and Cleaning Instructions	10
Guidelines for Vacuum Packaging	11
Preservation Guidelines	14
Troubleshooting	16

## Important instructions – retain for future use.

تأكد من تفهّم احتياطات السلامة المذكورة أعلاه

請務必理解上述的安全預防措施。

Assurez-vous que les précautions ci-dessus relatives à la sécurité sont bien comprises

Versichern Sie sich, dass die obenstehenden Sicherheitsmaßnahmen Verstanden werden

Βεβαιώστε πως οι παραπάνω προφυλάξεις ασφαλείας γίνονται κατανοητές

Pastikan bahwa tindakan-tindakan keselamatan seperti di atas dimengerti anda

Accertatevi che le suddette norme di sicurezza siano comprese a dovere

上記の注意事項をよくお読みになり、安全を御確認ください

Уверете се дека погоре споменатите мерки на претпазливост се добро разбрани

Asegúrese de que las precauciones de seguridad precedentes sean bien comprendidas

کاری بکنید کہ احتیاط‌های بالا حتماً درک بشوند

ต้องแน่ใจว่า ข้อควรระวังเรื่องความปลอดภัยข้างต้น เป็นที่เข้าใจกันดี

Yukarda belirtilen güvenlik önlemlerinin anlaşıldığından emin olunuz

Xin kiểm chắc rằng những biện pháp làm an toàn kể trên được hiểu rõ

# Important Safeguards

Read the Instructions Carefully.

For Your Own Safety, Always Follow These Basic Precautions When Using the FoodSaver® Appliance:

---

**Sunbeam is very safety conscious when designing and manufacturing consumer products, but it is essential that the product user also exercise care when using an electrical appliance. Listed below are precautions which are essential for the safe use of an electrical appliance:**

- Read carefully and save all the instructions provided with an appliance.
- Always turn the power off at the power outlet before you insert or remove a plug. Remove by grasping the plug - do not pull on the cord.
- Turn the power off and remove the plug when the appliance is not in use and before cleaning.
- Do not use your appliance with an extension cord unless this cord has been checked and tested by a qualified technician or service person.
- Always use your appliance from a power outlet of the voltage (A.C. only) marked on the appliance.
- This appliance is not intended for use by persons (including children) with reduced physical, sensory or mental capabilities, or lack of experience and knowledge, unless they have been given supervision or instruction concerning use of the appliance by a person responsible for their safety.
- Children should be supervised to ensure that they do not play with the appliance.
- The temperature of accessible surfaces may be high when the appliance is operating.
- Never leave an appliance unattended while in use.
- Do not use an appliance for any purpose other than its intended use.
- Do not place an appliance on or near a hot gas flame, electric element or on a heated oven.
- Do not place on top of any other appliance.
- Do not let the power cord of an appliance hang over the edge of a table or bench top or touch any hot surface.
- Do not operate any electrical appliance with a damaged cord or after the appliance has been damaged in any manner. If damage is suspected, return the appliance to the nearest Sunbeam Appointed Service Centre for examination, repair or adjustment.
- For additional protection, Sunbeam recommend the use of a residual current device (RCD) with a tripping current not exceeding 30mA in the electrical circuit supplying power to your appliances.
- Do not immerse the appliance in water or any other liquid unless recommended.
- Appliances are not intended to be operated by means of an external timer or separate remote control system.
- This appliance is intended to be used in household and similar applications such as: staff kitchen areas in shops, offices and other working environments; farm houses; by clients in hotels, motels and other residential type environments; bed and breakfast type environments.

If you have any concerns regarding the performance and use of your appliance, please visit [www.sunbeam.com.au](http://www.sunbeam.com.au) or contact the Sunbeam Consumer Service Line.

Ensure the above safety precautions are understood.

# Vacuum Packaging tips

## When Vacuum Packaging:

1. Vacuum packaging is NOT a substitute for refrigeration.
2. Use only FoodSaver® bags, rolls and containers.
3. During the vacuum packaging process, small amounts of liquids, crumbs or food particles can be inadvertently pulled into the Vacuum Channel. Empty the Drip Tray after each use.
4. You can prevent liquids from being drawn into the appliance by placing a folded paper towel at the top of the bag, but below the seal area, before vacuum packaging.
5. Do not attempt to create your own side seals for a FoodSaver® Bag. These bags are manufactured with special side seams which are sealed all the way to the outer edge. Creating your own side seams can actually leave air channels exposed which will cause leakage and prevent a vacuum from being formed.
6. Always make sure you leave at least 2.5 cm of extra bag material for each time you plan to reuse the bag. To avoid possible illness, **do not reuse bags after storing meats, fish or greasy foods.**
7. If you are not sure whether you have achieved a complete seal, simply seal the bag again about 1cm above the first seal.
8. Bulky items sometimes make it difficult to achieve a smooth sealing surface. Gently stretch the bag flat along the Sealing Strip before closing the lid.
9. When packaging products with sharp edges (dry spaghetti, silverware, etc.), protect the bag from punctures by wrapping the products in a cushioning material, such as paper towels, styrofoam, tissue, etc. Products can also be vacuum packaged in containers to avoid any possibility of puncturing a bag.
10. Avoid drawing powdery or fine-grained products such as, flour, sugar and coffee grinds into the appliance. This will inhibit the vacuuming and sealing process and may clog the unit, preventing it from drawing a good vacuum. To prevent this from occurring, avoid overfilling the bags or alternatively use containers.
11. If using the FoodSaver® appliance to re-seal packets, ensure that these have been previously commercially heat sealed.

# VS4500 FoodSaver® Lock & Seal

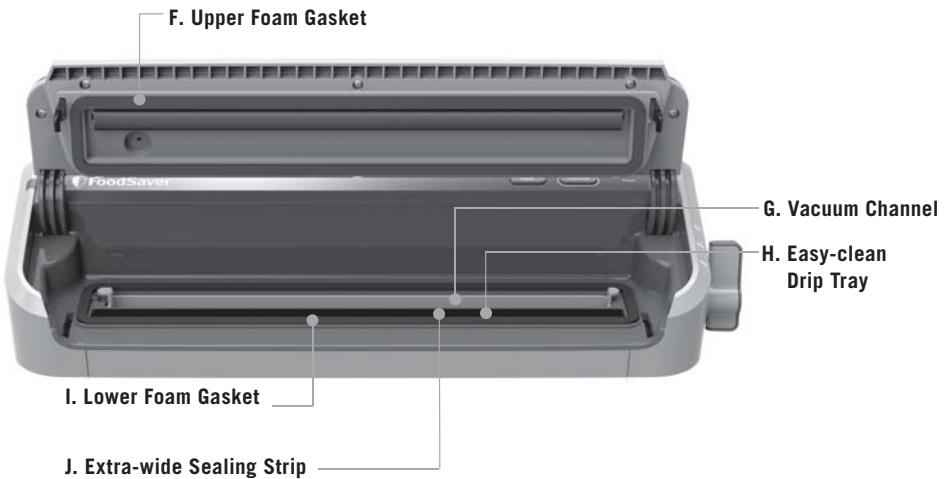
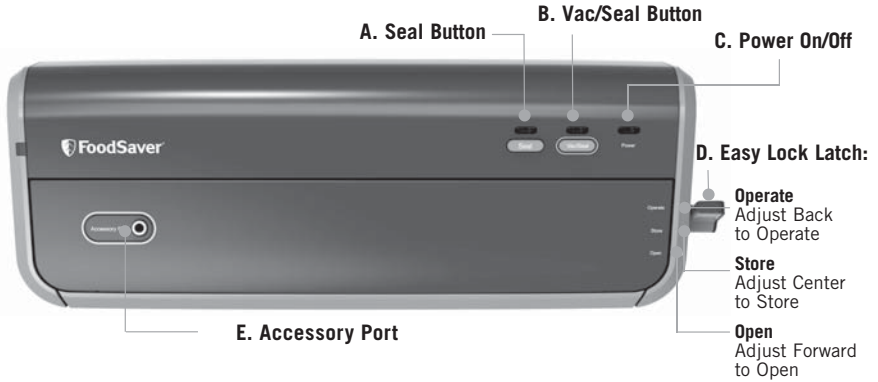

## K. Handheld Sealer

Use with zipper bags and containers, ideal for fresh food and snacks.



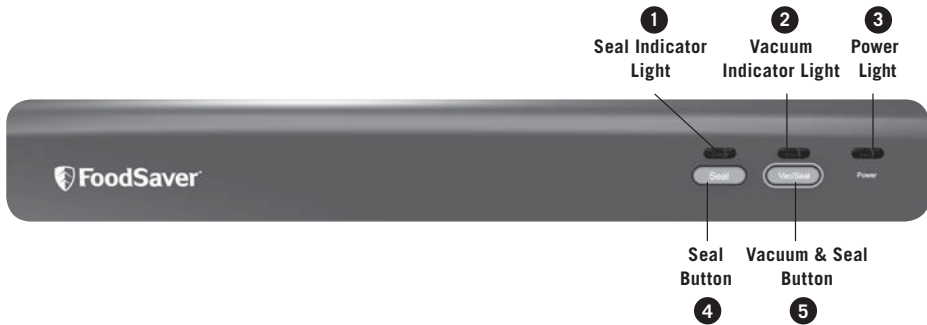

**1 Seal Indicator Light**

*This light has two uses:*

1. Constant light indicates Sealing process is engaged.
2. Flashes to indicate error.

**2 Vacuum Indicator Light**

Shows Vacuum and Seal process is engaged. Shuts off when the full process is finished.

**3 Power Light**

Illuminates when the unit is in the OPERATE position. Shuts off automatically when latch is not in OPERATE position.

**4 Seal Button**

*This button has three uses:*

1. Press to create a seal when making bags from a FoodSaver® Roll.
2. Press to immediately stop the vacuum process and begin sealing the bag. This prevents crushing delicate items such as bread, cookies and pastries.
3. Press to create a seal on multilayer film bags (such as a potato chip bag) to keep food sealed airtight.

**5 Vacuum & Seal Button**

*This button has two uses:*

1. Press to vacuum seal and seal food airtight. Appliance shuts off automatically.
2. Press to pause vacuum process at any point.

# Using your FoodSaver® Lock & Seal

## How to make a Bag from a FoodSaver® Roll

1. Using scissors, cut enough bag material from roll to hold item, plus 7.5cm. Be sure to cut straight.
2. Move Easy Lock Latch to the open position. Open appliance lid. Insert one end of bag material across Sealing Strip.
3. Close lid and turn Easy Lock Latch to OPERATE position.
4. Press Seal button.
5. When Seal Indicator Light turns off, sealing is complete. Turn latch to OPEN position, lift lid and remove bag.

Now you are ready to vacuum seal with your new bag (see page 6).

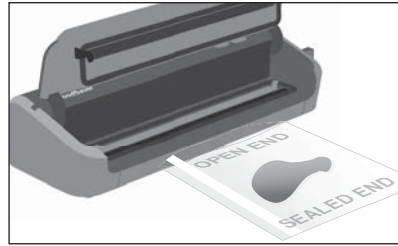

*Place Bag on Sealing Strip*

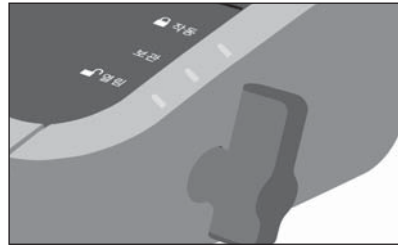

*Close and turn Easy Lock Latch to OPERATE position*

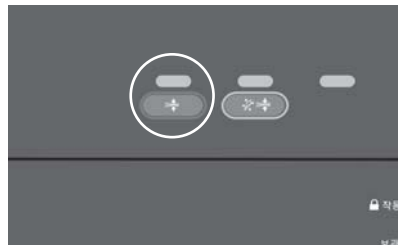

*Press Seal Button*

## How to Vacuum Seal FoodSaver® Bags

1. Place item(s) in bag, allowing at least 7.5cm of space between bag contents and top of bag.
2. Open appliance lid and place open end of bag into Vacuum Channel.
3. Close lid and turn Easy Lock Latch to OPERATE position.
4. Press Vacuum & Seal Button to begin vacuum and sealing process. Motor will continue to run until bag is fully vacuumed, then will automatically seal.
5. When Seal Indicator Light turns off, turn Latch to OPEN position, lift lid and remove bag. Refrigerate or freeze if needed. (See FoodSaver® Storage Guide, page 14, for safe food storage tips.)

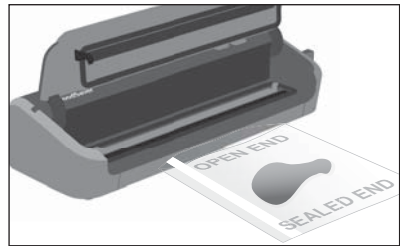

*Place Bag in Vacuum Channel*

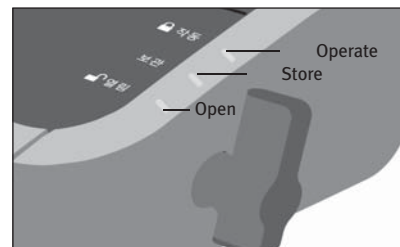

*Close and Latch Lid*

**NOTE:** Let appliance cool down for 20 seconds after each use. Always store appliance with the Easy Lock Latch in the center STORE position.

### Important Tips:

To minimize bag waste do not insert too much. Only insert bag over the edge of the removable drip tray.

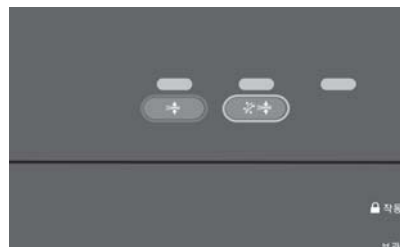

*Press Vacuum & Seal Button*



### Tips on sealing & vacuuming a bag

**Make sure you've securely locked the FoodSaver® appliance lid.** When making a bag from a roll, place bag material on the sealing strip, close and lock the lid.

**Prevent moisture or liquid from being pulled into the Vacuum Channel or trapped in the seal.** For very moist or wet foods either use Seal only, or pre-freeze for 1-2 hours before vacuum packaging. Alternatively place a folded paper towel between food and end of bag to absorb excess liquids. Just be sure to leave at least 7.5cm between food and end of bag so that bag seals properly with paper towel inside.

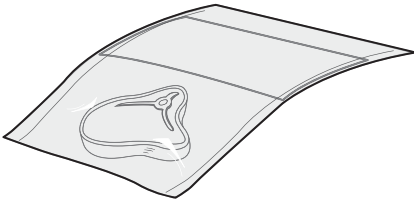

**Make sure you give FoodSaver® appliance time to cool down.** Under heavy usage, appliance will not operate to prevent overheating. If it does, wait 10 - 20 minutes to allow appliance to cool off.

### Vacuum packaging in bulk

To package a large number of bags at one time, it is recommended to:

- create bag
- place foods in bag
- vacuum & seal
- repeat

Following this process will prevent the appliance from overheating.

**Make sure you've securely locked the FoodSaver® appliance lid.** When vacuuming and sealing a bag or container ensure the lid has been fully closed and lid has locked into place.

**Check for wrinkles in the bag along the Sealing Strip.** Wrinkles in seal may cause leakage and allow air to come back into bag. Check for wrinkles in bag along Sealing Strip before closing lid and vacuum packaging. If you find wrinkles after sealing bag, simply cut bag open and vacuum seal again.

**If the motor runs for more than 2 minutes without stopping,** consider the following:

- adjust the bag and try again.
- if you are making an initial seal on a piece of bag material with two open ends, make sure the bag is placed on the sealing strip.
- if you are vacuum packaging with a bag, make sure the open end is placed down inside the vacuum channel.
- ensure the accessory hose is not attached.

# Vacuum Sealing Accessories

## For Containers

1. Prepare container according to FoodSaver® Accessory Guidelines (see manual that comes with your Accessory Kit).
2. Insert one end of Accessory Hose into Accessory Port on appliance. Press the Handheld Sealer over the accessory.

**NOTE:** For Containers and Bottle stoppers without green oval buttons on lid, remove the clear bottom portion of Handheld Sealer from top handle. Insert the green tip into the hole on top of the container lid or into the bottle stopper. Twist the green tip of the hose while inserting to ensure a tight fit.

3. Close lid, rotate Latch to OPERATE position, press Vacuum & Seal Button.
4. When motor and Indicator Light turn off, vacuum process is complete. Note that the appliance will still go through sealing cycle even when vacuuming an accessory. You will hear Motor shut off and then the sealing cycle will begin.
5. Gently twist and remove Handheld Sealer from accessory and appliance.
6. To test vacuum, simply tug on accessory lid. It should not move.

**NOTE:** For important tips on using accessories with different foods, please refer to the FoodSaver® Storage Guide on page 14.

## For Zipper bags

1. To use Handheld sealer with Vacuum Zipper Bags, lay bag flat with grey circle facing upwards. Squeeze air out of the bag and seal closed completely.
2. Place Handheld Sealer over grey circle on bag and press Vacuum & Seal button.

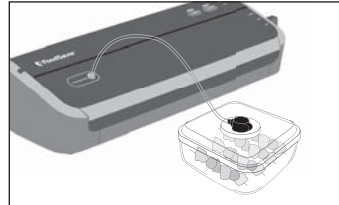

Connect Accessory Hose to both accessory port on appliance and port on accessory

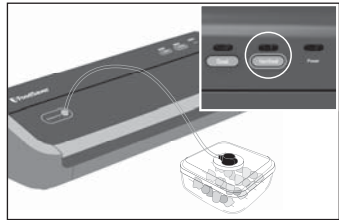
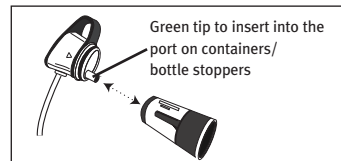

Press Vacuum & Seal Button

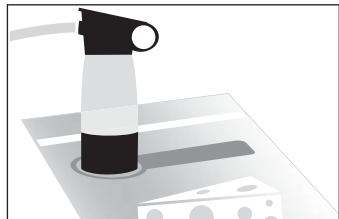

Vacuum sealing zipper bags

# Food Preparation & Safety Tips

## **Guidelines for Vacuum Packaging Food**

Vacuum packaging is not a substitute for canning nor can it reverse deteriorating quality; it can only slow down changes in quality. It is impossible to predict how long a specific food will have top-quality flavour, appearance and texture, because it depends on the age and condition of the food on the day it was vacuum packaged. Foods that are extremely fresh will last longer than foods that are already deteriorating.

Vacuum packaging extends the life of foods by removing nearly all the air in a sealed container, thereby reducing oxidation which affects nutritional value, flavour and overall quality. However, most foods contain enough water to support micro-organisms which can grow with or without air. While micro-organisms are present everywhere, only certain ones cause problems, and only under certain conditions:

- **Mould:** Easy to identify because of its characteristic fuzz. Moulds are virtually eliminated by vacuum packaging because they cannot grow in a low oxygen environment.
- **Yeast:** Results in fermentation, which can frequently be identified by smell or taste. Yeast requires water, sugar and a moderate temperature to grow, and can grow with or without air. Refrigeration slows the growth of yeast, and freezing stops it completely.

- **Bacteria:** Frequently results in discolouration, soft or slimy texture, and/or an unpleasant odour. 'Clostridium botulinum' (the organism that causes Botulism) can grow without air under the right conditions, cannot be detected by smell or taste, and although extremely rare, can be very dangerous.

## **Thawing and Heating Vacuum Packaged Foods**

Always thaw foods in either the refrigerator or microwave – do not leave “perishable” foods at room temperature to thaw.

To microwave in a FoodSaver® Bag, cut a corner of the bag and place on a microwave-safe dish.

## **The combination of vacuum packaging and freezing will extend food freshness and reduce the growth of bacteria in perishable foods.**

Maintaining low temperatures is a critical factor in preserving foods safely. Growth of micro-organisms is significantly reduced at temperatures of 4°C or below. Freezing at -17°C does not kill micro-organisms, but it stops them from growing. For long term storage, always freeze “perishable” foods that have been vacuum packaged.

**NOTE: Vacuum packaging is NOT a substitute for refrigeration or freezing. Any “perishable” foods that require refrigeration prior to vacuum packaging still must be refrigerated or frozen after vacuum packaging.**

# Care and Cleaning Instructions

## The FoodSaver® Appliance

1. Always unplug the appliance before cleaning.
2. Clean using a mild dishwashing soap and a warm, damp cloth. Do not immerse the appliance in water. Dry thoroughly before using.
3. Do not use abrasive products or materials to clean any of the appliance components.

## Drip Tray

Remove from appliance for easy clean.  
Clean drip tray in warm soapy water.

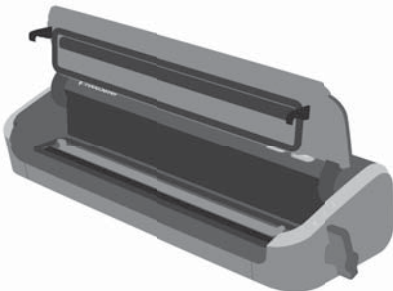

## FoodSaver® Bags

**IMPORTANT:** Do not reuse bags after storing meats, fish or greasy foods.

1. Wash bags in warm water using a mild dishwashing soap.
2. Bags can be washed in the dishwasher by carefully turning the bags inside out and spreading them over the top rack of the dishwasher so that all surfaces are exposed to the washing water.
3. Allow bags to dry thoroughly before reusing. To avoid possible illness, do not reuse bags after storing raw meats, fish or greasy foods. **Do not reuse bags that have been microwaved or simmered.**

## FoodSaver® Accessories

1. All FoodSaver® accessories should be washed in warm water using a mild dishwashing soap. Dry thoroughly before using.
2. The FoodSaver® Fresh Containers can be cleaned in the dishwasher but only in the top shelf. Items washed in bottom shelves can distort due to the heat from the dishwasher element. FoodSaver® Quick Marinator lids are NOT dishwasher safe

**IMPORTANT:** All plastic components deteriorate through the prolonged use of a dishwasher for cleaning. Hand washing of plastic components in warm soapy water is always recommended.

## To Store Appliance

Clean unit thoroughly.

After the unit has been cleaned and allowed to fully dry, close lid and push the Easy Lock Latch into the STORE (middle) position. This setting will keep the lid closed but avoid and pressure being applied to the gaskets.

Always leave lid latch in STORE position when not in use. **Never store lid in OPERATE position as gaskets may become compressed.** If gaskets become compressed the unit may not function properly.

# Guidelines for Vacuum Packaging

## Vacuum Packaging and Food Safety

The vacuum packaging process extends the life of foods by removing most of the air from the sealed container. This reduces oxidation, which affects nutritional value, flavour and overall quality.

Removing air can also inhibit growth of micro organisms, which can cause problems under certain conditions such as mould, yeast and bacteria.

### **IMPORTANT: Vacuum packaging is NOT a substitute for refrigeration or freezing**

Any perishable foods that require refrigeration must still be refrigerated or frozen after vacuum packaging.

## Thawing and Reheating Vacuum Packaged Foods

Always thaw foods in either refrigerator or microwave — do not thaw perishable foods at room temperature.



### **Reheating in a microwave**

To reheat foods in a microwave in a FoodSaver® Bag, always cut corner of the bag before placing it on a microwave-safe dish. However, to avoid hot spots, do not reheat bone-in meat or greasy foods in microwave within a FoodSaver® Bag.

### **Reheating in water**

You can also reheat foods in FoodSaver® Bags by placing them in water at a low simmer below 75°C.



## Vacuum Packaging Meat and Fish:

For best results, use a FoodSaver® bag to vacuum seal before freezing.

For very moist meat or fish, place a folded paper towel in the bag, between meat/fish and top of bag, below seal area. Leave paper towel in bag to absorb excess moisture and juices during vacuum packaging process.

**Note:** Beef may appear darker after vacuum packaging due to the removal of oxygen. This is not an indication of spoilage.



## Vacuum Packaging Hard Cheeses:

To keep cheese fresh, vacuum package it after each use. To continue using the same bag, when initially vacuum packaging the cheese, ensure the FoodSaver® Bag is extra long. Allow one inch of bag material for each time you plan to open and reseal the bag in addition to the 7.5cm space you normally leave between contents and seal. Simply cut sealed edge and remove cheese prior to use. When you're ready to repack the cheese, just drop it in bag and reseal.

**IMPORTANT: Due to the risk of anaerobic bacteria, Soft cheeses should never be vacuum packaged.**

## Guidelines for Vacuum Packaging continued



### **Vacuum Packaging Vegetables:**

It is recommended that vegetables are blanched before vacuum packaging.

This process stops the enzyme action that could lead to loss of flavour, colour and texture.

To blanch vegetables, place them in boiling water or in the microwave until they are cooked, but still crisp.

Approximate blanching times:

- 1 to 2 minutes for leafy greens and peas
- 3 to 4 minutes for snap peas, sliced zucchini or broccoli
- 5 minutes for carrots
- 7 to 11 minutes for corn on the cob.

After blanching, immerse vegetables in cold water to stop the cooking process.

Dry vegetables on a towel before vacuum packaging.

**Note:** All vegetables (including broccoli, Brussels sprouts, cabbage, cauliflower, kale, turnips) naturally emit gases during storage. Therefore, after blanching, they must be stored in freezer only.

**IMPORTANT:** Due to the risk of anaerobic bacteria, Fresh mushrooms, onions, & garlic should never be vacuum packaged.



### **Vacuum Packaging Leafy Vegetables:**

For best results, use a container to store leafy vegetables. First wash the vegetables, and then dry with a towel or salad spinner.

After they are dried, put them in a container and vacuum package. Store in refrigerator.



### **Vacuum Packaging Fruits:**

For best results, vacuum seal fruit in a FoodSaver® Container to protect the shape of berries and soft fruits. Alternatively pre-freeze fruit for 1-2 hours before vacuum sealing to help maintain the shape and flavour of the food.

If storing in the refrigerator, we recommend using a FoodSaver® Container.



### **Vacuum Packaging Baked Goods:**

To vacuum package soft or airy baked goods, we recommend using a FoodSaver® Container so they will hold their shape. If using a bag, pre-freeze for 1-2 hours or until solidly frozen. To save time, make cookie dough, pie shells, whole pies, or mix dry ingredients in advance and vacuum package for later use.

## Guidelines for Vacuum Packaging continued



### Vacuum Packaging Coffee and Powdery Foods:

To prevent food particles from being drawn into vacuum pump, place a coffee filter or paper towel inside the bag, above the coffee and below the top of the bag, before vacuum packaging.

You can also place the food in its original bag inside a FoodSaver® Bag.



### Vacuum Packaging Liquids:

Using a FoodSaver® Container is the easiest way to vacuum seal liquids. Pouring liquids into a FoodSaver® bag then using Seal only is a quick way to prepare liquids for storage.

Alternatively pre-freeze liquids until solid, remove from freezer and vacuum package in a FoodSaver® bag. Then return to the freezer. When you're ready to use, just cut corner of bag and place in a dish in microwave or drop into water at a low simmer, below 75°C.



### Vacuum Packaging Snack Foods:

Your snack foods will maintain their freshness longer when you vacuum package them. For best results, use a FoodSaver® Container for crushable items like crackers.

### Vacuum Packaging Non-Food Items

The FoodSaver® vacuum packaging system also protects non-food items from oxidation, corrosion and moisture. Simply follow the directions to vacuum package items using FoodSaver® Bags & Containers.



To vacuum package silver, wrap forks in soft cushioning material, such as a paper towel, to avoid puncturing bag.



Your FoodSaver® Bags are ideal for outdoor excursions. For camping and hiking, keep your matches, maps and food dry and compact.



To have fresh water for drinking, simply fill a FoodSaver® Bag with ice, seal it and when needed, let the ice pack melt.



If you're going sailing or boating, vacuum package your food, film and a dry change of clothes. Just remember to bring scissors or a knife to open the bag.



To keep emergency kits safe and dry, vacuum package flares, batteries, flashlights, matches, candles and other necessities. Your emergency items will stay dry and organized in your home, car or boat.

### Natural Gases in Foods

The release of natural gases or fermentation from foods, (such as fresh fruits and vegetables) can add air back into a vacuum packaged bag. To prevent this occurring, vegetables can be blanched prior to vacuum packing. See page 13 for more details. Pre-freezing meats prior to vacuum packaging can prevent natural gases being released.

# Preservation Guidelines

Foods	Where to Store	Recommended FoodSaver® Accessory	Storage Life with FoodSaver® Vacuum Packaging System	Normal Storage Life
<b>Meat</b>				
Beef, Pork, Lamb	Freezer	FoodSaver® Bag	2-3 years	6 months
Ground Meat	Freezer	FoodSaver® Bag	1 year	4 months
Poultry	Freezer	FoodSaver® Bag	2-3 years	6 months
Fish	Freezer	FoodSaver® Bag	2 years	6 months
<b>Hard Cheeses</b>				
Cheddar, Swiss	Refrigerator	FoodSaver® Bag, Container	4-8 months	1-2 weeks
Parmesan	Refrigerator	FoodSaver® Bag, Container	4-8 months	1-2 weeks
<b>Vegetables</b> (Vegetables, excluding leafy types, must be blanched before vacuum sealing.)				
Asparagus	Freezer	FoodSaver® Bag	2-3 years	8 months
Broccoli, Cauliflower	Freezer	FoodSaver® Bag	2-3 years	8 months
Cabbage, Brussels Sprouts	Freezer	FoodSaver® Bag	2-3 years	8 months
Corn (cob or kernel)	Freezer	FoodSaver® Bag	2-3 years	8 months
Green Beans	Freezer	FoodSaver® Bag	2-3 years	8 months
Lettuce, Spinach	Refrigerator	FoodSaver® Container	2 weeks	3-6 days
Snow Peas, Snap Peas	Freezer	FoodSaver® Bag	2-3 years	8 months
<b>Fruits</b>				
Apricots, Plums	Freezer	FoodSaver® Bag	1-3 years	6-12 months
Peaches, Nectarines	Freezer	FoodSaver® Bag	1-3 years	6-12 months
<b>Softer Berries</b>				
Raspberries, Blackberries	Refrigerator	FoodSaver® Container	1 week	1-3 days
Strawberries	Refrigerator	FoodSaver® Container	1 week	1-3 days
<b>Harder Berries</b>				
Blueberries	Refrigerator	FoodSaver® Container	2 weeks	3-6 days
Cranberries	Refrigerator	FoodSaver® Container	2 weeks	3-6 days



## Preservation Guidelines continued

Foods	Where to Store	Recommended FoodSaver® Accessory	Storage Life with FoodSaver® Vacuum Packaging System	Normal Storage Life
<b>Baked Goods</b>				
Bagels, Bread, Pastries	Freezer	FoodSaver® Bag	1-3 years	6-12 months
<b>Nuts</b>				
Almonds, Peanuts	Pantry	FoodSaver® Bag, Container	2 years	6 months
Sunflower Seeds	Pantry	FoodSaver® Bag, Container	2 years	6 months
<b>Coffee</b>				
Coffee Beans	Freezer	FoodSaver® Bag	2-3 years	6 months
Coffee Beans	Pantry	FoodSaver® Bag, Container	1 year	3 months
Ground Coffee	Freezer	FoodSaver® Bag	2 years	6 months
Ground Coffee	Pantry	FoodSaver® Bag, Container	5-6 months	
<b>Prepared Liquids</b>				
Sauces, Soups, Stews	Freezer	FoodSaver® Bag	1-2 years	3-6 months
<b>Bottled Liquids</b>				
Wine	Refrigerator	FoodSaver® Bottle Stopper	2-4 months	1-3 weeks
Oils	Pantry	FoodSaver® Bottle Stopper	1-1½ years	5-6 months
<b>Dry Foods</b>				
Beans, Grains	Pantry	FoodSaver® Bag, Container	1-2 years	6 months
Pasta, Rice	Pantry	FoodSaver® Bag, Container	1-2 years	6 months
<b>Powdery Foods</b>				
Dry Milk	Pantry	FoodSaver® Bag, Container	1-2 years	6 months
Dried Coconut	Pantry	FoodSaver® Bag, Container	1-2 years	6 months
Flour	Pantry	FoodSaver® Bag, Container	1-2 years	6 months
Sugar, Brown Sugar	Pantry	FoodSaver® Bag, Container	1-2 years	6 months
<b>Snack Foods</b>				
Chips	Pantry	FoodSaver® Container	3-6 weeks	1-2 weeks
Cookies, Crackers	Pantry	FoodSaver® Container	3-6 weeks	1-2 weeks

# Troubleshooting

<b>Problem</b>	<b>Solution</b>
Red Seal LED flashing	<ul style="list-style-type: none"><li>• Always wait 20 seconds between seals.</li><li>• Unit is overheated, wait for 20 minutes for unit to cool down</li><li>• If trying to seal an end of a roll to make a bag, make sure the bag is on the seal strip</li><li>• If storing unit, make sure that latch is in Store position and not Closed position. If in Closed position for extended period of time the gaskets become compressed.</li></ul>
Pump is running for more than 2 minutes without bag vacuuming (no visible air coming out of bag)	<ul style="list-style-type: none"><li>• Make sure bag is inserted curl down in the vacuum channel.</li><li>• Check to make sure top and bottom gaskets are inserted properly.</li><li>• Check to make sure that at least one end of bag is sealed.</li><li>• Open unit and check to make sure that there are no foreign objects, dirt or debris on the top or bottom gasket.</li><li>• Make sure there is enough room at top of bag (7.5cm) to fit to middle of drip tray with lid closed and latched.</li><li>• Make sure accessory hose is not attached.</li><li>• Make sure the lid is latched down all of the way.</li></ul>
Bag is not sealing properly	<ul style="list-style-type: none"><li>• There is too much liquid in bag, freeze bag contents before vacuuming.</li><li>• To prevent wrinkles in the seal, gently stretch bag flat while inserting bag into vacuum channel and continue to hold bag until vacuum pump starts.</li><li>• Create a second seal above the first seal on the bag to ensure a proper seal when sealing moist foods.</li></ul>
There are no lights on the control panel	<ul style="list-style-type: none"><li>• Make sure unit is plugged in.</li><li>• Make sure wall outlet is functional.</li><li>• Make sure latch is in Closed position.</li></ul>
Nothing happens when latch is closed and Vac/Seal or Seal button is pressed	<ul style="list-style-type: none"><li>• Make sure unit is plugged in.</li><li>• Make sure wall outlet is functional.</li><li>• Open latch, make sure lid is all the way down, re-latch lid.</li><li>• The appliance will shut off automatically if overheated. Allow to cool down for 20 minutes and try again.</li></ul>

Problem	Solution
Air was removed from the bag, but has come back into the bag	<ul style="list-style-type: none"> <li>• Leaks along the seal can be caused by wrinkles, crumbs, grease or liquids. Reopen bag, wipe the top inside of the bag and smooth it out along the sealing strip before resealing.</li> <li>• The release of natural gases or fermentation from foods, (such as fresh fruits and vegetables) may have occurred. Most vegetables require blanching prior to vacuum packing. See page 14 for more details. Open bag, if you think food has begun to spoil, discard food. Lack of refrigeration or fluctuating temperatures in the Refrigerator can cause food to spoil.</li> <li>• Check the bag for a puncture or hole, which may have released the vacuum. Cushion sharp edges in the contents of the bag with paper towels.</li> </ul>
The Bag Melts:	<ul style="list-style-type: none"> <li>• Should sealing strip overheat and melt the bag, it may be necessary to lift the lid and allow sealing strip to cool for a few minutes.</li> <li>• Built-in safety shut-off may shut the appliance off if it becomes overheated. Allow the unit to cool down for 20 minutes and try again.</li> </ul>
The FoodSaver® Container will not vacuum	<ul style="list-style-type: none"> <li>• Make sure the rubber gasket on the container lid is free from food materials, crumbs, coffee grinds, etc.</li> <li>• Make sure the rim of the container does not have any cracks or scratches. Any gaps can prevent a vacuum from forming.</li> <li>• Make sure you aren't filling the container too full prior to vacuum packaging. Never fill container past the MAX line marked.</li> </ul> <p><b>NOTE:</b> For all accessories, make sure the Accessory Hose is completely inserted into appliance and lid of accessory. Twist grey tab on Accessory Hose while inserting to ensure a tight fit.</p>
Gasket is loose or has a tear	<ul style="list-style-type: none"> <li>• Remove gasket, clean then reinsert into the vacuum channel.</li> <li>• Call customer service for a replacement.</li> </ul>

# Notes

# Notes

# Notes

# 12 Month Replacement Guarantee

This Sunbeam product is covered by a 12 month replacement or repair warranty, which is in addition to your rights under the Australian Consumer Law (if your product was purchased in Australia) or New Zealand Consumer Guarantees Act (if your product was purchased in New Zealand).

Upon receipt of your claim, Sunbeam will seek to resolve your difficulties or, if the product is defective, advise you on how to obtain a replacement or refund.

To assist us in managing warranty claims, we recommend you register your product as soon as practicable after purchase by creating a MySunbeam account on our website and uploading a copy of your original receipt.

In order to make a claim under our warranty, you must have the original proof of purchase documentation for the product and present it when requested (if not already uploaded to our website).

Should your product develop any defect within 12 months of purchase because of faulty materials or workmanship, we will replace or repair it, at our discretion, free of charge. A product presented for repair may be replaced by a refurbished product of the same type rather than being repaired. Refurbished parts may be used to repair the product.

Our replacement or repair warranty only applies where a defect arises as a result of faulty material or workmanship during the warranty period. Your warranty does not cover misuse or negligent handling (including damage caused by failing to use the product in accordance with this instruction booklet), accidental damage, or normal wear and tear.

Your warranty does not:

- cover freight or any other costs incurred in making a claim, consumable items, accessories that by their nature and limited lifespan require periodic renewal (such as filters and seals) or any consequential loss or damage; or
- cover damage caused by:
  - power surges, power dips, voltage supply problems, or use of the product on incorrect voltage;

- servicing or modification of the product other than by Sunbeam or an authorised Sunbeam service centre;
- use of the product with other accessories, attachments, product supplies, parts or devices that do not conform to Sunbeam specifications; or
- exposure of the product to abnormally corrosive conditions; or

- extend beyond 3 months if the product is used in commercial, industrial, educational or rental applications.

**The benefits given to you by our warranty are in addition to other rights and remedies under law in relation to the product.**

**In Australia our goods come with guarantees that cannot be excluded under the Australian Consumer Law. You are entitled to a replacement or refund for a major failure and for compensation for any other foreseeable loss or damage. You are also entitled to have the goods repaired or replaced if the goods fail to be of acceptable quality and the failure does not amount to a major failure.**

**Our goods also come with guarantees that cannot be excluded under the New Zealand Consumer Guarantees Act.**

If your warranty claim is not accepted, we will inform you and if requested to do so by you, repair the product provided you pay the usual charges for such repair. You will also be responsible for all freight and other costs.

Should your product require repair or service after the warranty period, contact your nearest Sunbeam service centre. For a complete list of Sunbeam's service centres, visit our website or call our customer service line for advice on 1300 881 861 in Australia, or 0800 786 232 in New Zealand.

Should you experience any difficulties with your product during the warranty period, please contact our customer service line for advice on 1300 881 861 in Australia, or 0800 786 232 in New Zealand.

## Australia

[www.sunbeam.com.au](http://www.sunbeam.com.au)  
1300 881 861  
Units 5 & 6,  
13 Lord Street,  
Botany NSW 2019  
Australia

## New Zealand

[www.sunbeam.co.nz](http://www.sunbeam.co.nz)  
0800 786 232  
Level 6, Building 5,  
Central Park,  
660-670 Great South Road,  
Greenlane, Auckland  
New Zealand

## Need help with your appliance?

Contact our customer service team or visit our website for information and tips on getting the most from your appliance.

**Australia** | visit [www.sunbeam.com.au](http://www.sunbeam.com.au)  
phone 1300 881 861  
mail Units 5 & 6, 13 Lord Street,  
Botany NSW 2019 Australia.

**New Zealand** | visit [www.sunbeam.co.nz](http://www.sunbeam.co.nz)  
phone 0800 786 232  
mail Level 6, Building 5,  
Central Park,  
660-670 Great South Road,  
Greenlane, Auckland.

Distributed by:  
Sunbeam Corporation Pty Ltd  
ACN 000 006 771

*Sunbeam* is a registered trade mark.

© 2017 Sunbeam Products Inc. doing business as  
Jarden Consumer Solutions. All rights reserved.  
FoodSaver® is a registered trademark of Sunbeam  
Products, Inc. Some images and text are copyrighted.