

Bar code

TOSHIBA

OWNER'S MANUAL

55Z770KP/55Z770KN/55Z770KV/55Z770KW
65Z770KP/65Z770KN/65Z770KV/65Z770KW

Owner's Record

You will find the model number and serial number on the back of the TV. Record these numbers in the spaces provided below. Refer to them whenever you call upon your Toshiba dealer regarding this product.

Model number:

Serial number:

Contents

Welcome to Toshiba

- Thank you for purchasing this Toshiba LED TV. This manual will help you use the exciting features of your new TV.
- Instructions in this manual are based on using the remote control.
- Please read all safety and operating instructions in this manual carefully, and keep this manual for future reference.
- LED TV is LCD Panel with LED Backlight.

Contents

Contents	1
Important Safety Precautions	2
Getting started	5
Accessories List	5
Installing the Stand or Wall Mount Bracket	5
TV Front	6
TV Rear	6
Terminals	7
Establishing a Wired Internet Connection	8
Establishing a Wireless Internet Connection	8
Connecting Bluetooth Devices	8
Using HDMI&CEC	9
Connecting a Digital Audio System to Use eARC/ARC	9
Connecting an AV device, a PC or a Game Console with an HDMI Cable ...	9
Connecting with an USB Cable	9
Remote Control	11
Buttons on the Remote Control	11
Installing Batteries in the Remote Control	13
Pairing the Remote Control	13
Remote Control Operation Range	13
Live TV	14
Channel Scan	14
Channel Edit	14
Channel List	14
Favourite	15
EPG(GUIDE)	15
PVR	16
Recording List	16
Timeshift	17
Multi-screen	18
Screen Sharing	18
Content Sharing	18

Smart Functions	19
Getting Familiar with the Home Screen	19
Apps	19
Using Far-Field Google Assistant to Control your TV	20
Installing Mobile App to Control your TV	20
Media	20
Picture and Sound	21
Adjusting the Picture Quality	21
Adjusting the Sound Quality	23
Accessibility and System	25
Using Parental Control	25
Configuring Device Preferences Settings	25
Configuring Advanced System Settings	26
Troubleshooting	28
Picture Problem	28
Sound Problem	28
Picture and Sound Problem	28
Internet Problem	28
Recording/Timeshift Function Isn't Working	29
My File Won't Play	29
Other Issues	29
Other Information	30
Specifications	30
Media Format List	31
License Information	34

Disclaimer:

Images throughout this document are for illustrative purposes only and may differ from the actual product.

Designs and specifications are subject to change without notice.

Important Safety Precautions

Be sure to observe the following instructions and precautions to ensure safe use of this TV.

Installation

1. **WARNING: To prevent injury, this apparatus must be securely attached to a stable surface/wall in accordance with the installation instructions.**

Install the TV in a horizontal, stable location.

- If the TV is not installed securely, it may lean or fall over and cause an injury.
- To prevent injury, use the exclusive optional stand or wall-hanging bracket to install this TV on a stable surface or wall securely in accordance with a qualified technician.
- To secure the TV, use a sturdy strap from the hook(s) on the rear of the TV to a wall stud, pillar, or other immovable structure. Make sure the strap is tight, secure, and parallel to the floor.

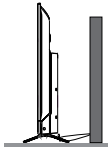

Only for the model with P-clip

2. **Never place the TV in an unstabilized location such as on a shaky table, incline or location subject to vibration.**

- Only use cabinets or stands recommended by the TV manufacturer.
- Only use furniture that can safely support the TV.
- Ensure that the TV is not hanging over the edge of the supporting furniture.
- Never place the TV on tall furniture (for example, cupboards or bookcases) without anchoring both the furniture and the TV to a suitable support.
- Never stand the TV on cloth or other material placed between the TV and supporting furniture.

The TV may drop or fall off, which may cause an injury or damage.

3. **Never stand or climb on the TV.**

- Educate children about the dangers of climbing on furniture to reach the TV or its controls.

Be especially careful in households with children to prevent them through climbing on top of the TV. It may move, fall over, break, become damaged or cause an injury.

4. **Always connect the power plug to an appropriate electrical outlet equipped with 100-240V AC, 50/60Hz.**

Never use the TV outside the specified voltage range. It may cause a fire or an electric shock.

About the fuse

In a three pin earthing-type, the fuse fitted in this plug is approved by ASTA or BSI to BS1362. It should only be replaced by a correctly rated and approved type and the fuse cover must be refitted.

About the use

- Make sure to insert the plugs firmly, when plugging the AC power cord into the TV set end and wall outlet end.
- Make sure to hold the plug, when unplugging the AC power cord.
- Never use other cord except for supplied AC power cord, and never use the supplied power cord for any other purpose.

5. **Never insert or remove the power plug with wet hands.**

This may cause an electric shock.

6. **Never block or cover the slots and openings in the cabinet.**

- Never place the TV so that it is facing upward or on its side.
- Never place the TV in a closet, bookcase or other similar area where the ventilation is poor.

- Never drape a newspaper, tablecloth or curtain on the TV.
- When installing the TV against a wall, always keep the TV at least 10cm away from the wall.
- Never place the TV on a soft unstable surface, such as a carpet, or a cushion.

The inside of this TV will overheat if the ventilation holes are covered, blocked or sealed, which may result in a fire.

7. **Never place the TV near a heater or in direct sunlight.**

The surface of the cabinet or power cord may melt and result in a fire or an electric shock.

8. **Never place the TV in an area exposed to high humidity levels, such as in a bathroom or close to a humidifier.**

This may cause a fire or an electric shock.

9. **Never place the TV next to a stove where it will be exposed to oil, smoke, or steam, or in a location where there is a large quantity of dust.**

This may cause a fire or an electric shock.

10. **Precautions for moving the TV.**

- When moving the TV, be sure to remove the plug from the wall outlet and disconnect the aerial cable and audio/video cables, any steady ties and mounting screw. A fire or an electric shock may result if the power cord is damaged.
- When carrying the TV, at least two people are needed. Be sure to carry it upright.
- Never carry the TV with the screen facing up or down.

11. **Precautions for installing on outdoor aerial.**

An outside aerial system should not be located in the vicinity of overhead power lines, or other electric light or power circuits.

If the aerial falls down or drops, it may cause an injury or an electric shock.

Use

1. **Never place hot objects or open flame sources, such as lighted candles or nightlights, on or close to the TV.**

High temperatures can melt plastic and lead to fires.

2. **The apparatus shall not be exposed to dripping or splashing and that no objects filled with liquids, such as vases, shall be placed on the apparatus.**

When liquids are spilled or small items are dropped inside the TV, this may cause a fire or an electric shock.

If small objects drop inside the TV, turn off the TV and remove the power plug from the outlet immediately and contact a service technician.

3. **Never insert objects (metal or paper) or pour water inside the TV through ventilation holes and other openings.**

These items may cause a fire or an electric shock. If these objects are inserted inside the TV, turn off the TV and remove the power plug from the outlet immediately and contact a service technician. Be especially careful that children do not insert objects in the TV.

4. **When the TV will not be used for a long period of time, such as during vacation or travel, remove the power plug from the wall outlet for safety.**

The TV is not completely disconnected from the power supply line, as minute current is consumed even when the Power switch is turned off.

The Mains plug or an appliance coupler is used as the disconnect device, therefore the disconnect device shall remain readily operable.

Important Safety Precautions

5. Never pull on the power cord when removing the plug from the wall outlet.

Always hold the plug firmly when removing it. If the power cord is yanked, the cord may become damaged and a fire or an electric shock may occur.

6. Never cut, break, modify, twist, bunch up or bent the cord or apply excessive force or tension to it.

Never place heavy objects on the cord or allow it to overheat as this may cause damage, a fire or an electric shock. Contact a service technician if the power cord is damaged.

7. If there is thunder or lightning, never touch the aerial cable or other connected cables.

You may suffer an electric shock.

8. Turn off the TV before unplugging the power cord.

Failure to do so, may cause a malfunction.

9. Listening to music at high volume levels and for extended durations can damage one's hearing.

In order to reduce the risk of damage to hearing, one should lower the volume to a safe, comfortable level, and reduce the amount of time listening at high levels.

10. In dry environment due to static electricity, the product may be restart and return to the main OSD interface, USB player interface or the previous source mode.

You can continue to use the TV when appear this phenomenon.

Service

1. Never repair, modify or disassemble the TV by yourself.

It may cause a fire or an electric shock.

Consult a service technician for inspection and repairs.

2. When a malfunction occurs, or if smoke or an unusual odor comes from the TV, turn off the TV and remove the power plug from the outlet immediately.

Make sure that the smoke or smell has stopped, then contact a service technician. If the TV is still used in this condition, it may cause a fire or an electric shock.

3. If the TV is dropped or the cabinet is broken, turn off the TV and remove the power plug from the outlet immediately.

If the TV has power in this condition, it may cause a fire or an electric shock. If the cabinet is broken, be careful when handling the TV to prevent an injury.

Contact a service technician for inspection and repair.

4. When the TV reaches the end of its useful life, ask a qualified service technician to properly dispose of the TV.

Cleaning

CAUTION: Avoid using chemicals (such as air refreshers, cleaning agents, etc.) on or near the TV pedestal. Studies indicate that plastics may weaken and crack over time from the combination effects of chemical agents and mechanical stress (such as weight of TV). Failure to follow these instructions could result in serious injury and/or permanent damage to TV and TV pedestal.

1. Remove the power plug before cleaning.

Never use solvents such as benzene or thinner to clean the TV.

- These solvents may distort the cabinet or damage its finish.
- If rubber or vinyl products remain in contact with the TV for a long time, a stain may result.

If the cabinet becomes dirty, clean it with a soft, dry cloth.

When cleaning the surface of the LED display, wipe the panel surface gently with a soft, dry cloth.

2. Periodically disconnect the power plug from the outlet and check it.

If dust has collected on the power plug connectors, clean off the dust with a dry cloth.

This dust may cause a fire due to reduced insulation on the plug.

Important information

1. About LCD screen

- If you have the LCD screen facing to the sun, the LCD screen will be damaged. Be aware of locating the TV close to a window or outdoors.
- Never press the LCD screen strongly or scratch it, and never put anything on it. These actions will damage the LCD screen.

2. About cabinet and LCD screen

Never spray volatile compounds such as insecticide on the cabinet and LCD screen. This may cause a discoloration or damage the cabinet and LCD screen.

3. About afterimage

If a still picture is displayed, an afterimage may remain on the screen, however it will disappear. This is not a sign of malfunction.

4. Some pixels of the screen do not light up

The LCD display panel is manufactured using an extremely high level of precision technology, however sometimes some pixels of the screen may be missing picture elements or have luminous spots. This is not a sign of malfunction.

5. About Interference

The LCD display may cause interference in image, sound, etc. of other electronic equipment that receives electromagnetic waves (e.g. AM radios and video equipment).

6. About using under the low temperature places

If you use the TV in the room of 0°C or less, the picture brightness may vary until the LCD monitor warms up. This is not a sign of malfunction.

7. When disposing of or transferring ownership of the TV

Before disposing of or transferring ownership of the TV, perform "Resetting the TV".

Important Safety Precautions

Recording using an USB storage device

- Be sure to select the correct country/region for use.
Use of the recording function may not be possible depending on the selected country/region.
Use with incorrect settings may violate certain laws or other regulations, and may result in criminal punishment.
In such cases, TOSHIBA CORPORATION and the Toshiba Group shall bear no responsibility whatsoever.
- The recording function has been designed for private use and entertainment in your home environment.
Please note that any commercial use of the recording function could lead to copyright infringement of authors' rights. Toshiba asks you to respect the intellectual property rights of third parties.
- Before recording to a device connected to the TV, make a test recording and check the recording performance.
- Toshiba shall not be liable for compensation or incidental damages of any kind whatsoever resulting from content that was not properly recorded on the recording device or that was modified or lost.
- Toshiba shall not be liable for damages of any kind whatsoever (breakdown of the recording device, modification or loss of the recorded content, etc.) resulting from malfunction, operating failure or incorrect operation due to combining with another connected device.
- Do not turn off the power supply to the USB storage device or disconnect the connecting cable while the USB storage device is operating. Doing so may result in loss of the recorded data or malfunction of the USB storage device.
- The recording function is not available in all countries/regions.
- Please note that recording on the USB storage device is no longer playable after the TV's main-board is exchanged during service.
- If the time information is incorrect, programed recording may not be performed properly.
Furthermore, if the time information differs according to the currently viewed channel, programed recording may not be performed properly depending on tuning operations.

Exemptions

- Toshiba is not liable for any damage caused by fires, natural disaster (such as thunder, earthquake, etc.), acts by third parties, accidents, owner's misuse, or uses in other improper conditions.
- Toshiba is not liable for incidental damaged (such as profit loss or interruption in business, modification or erasure of record data, etc.) caused by use or inability to use of product.
- Toshiba is not liable for any damage caused by neglect of the instructions described in the owner's manual.
- Toshiba is not liable for any damage caused by misuse or malfunction through simultaneous use of this product and the connected equipment.

When using a wireless network

CAUTION:

- Bluetooth™ and Wireless LAN devices operate within the same radio frequency range and may interfere with one another. If you use Bluetooth™ and Wireless LAN devices simultaneously, you may occasionally experience a less than optimal network performance or even lose your network connection.
- If you should experience any such problem, immediately turn off either your Bluetooth™ or Wireless LAN device.

- Actual performance can vary, including lower wireless network capacity, data throughput rate, range and coverage.
- Performance depends on many factors, conditions and variables, including distance from the access point, volume of network traffic, building materials and construction, operating system used, mix of wireless products used, interference and other adverse conditions.

Wireless LAN and your Health

Wireless LAN products, like other radio devices, emit radio frequency electromagnetic energy. The level of energy emitted by Wireless LAN devices, however, is far less than the electromagnetic energy emitted by wireless devices such as mobile phones.

Because Wireless LAN products operate within the guidelines found in radio frequency safety standards and recommendations, TOSHIBA believes Wireless LAN is safe for use by consumers. These standards and recommendation reflect the consensus of the scientific community and result from deliberations of panels and committees of scientists who continually review and interpret the extensive research literature.

In some situation or environments, the use of Wireless LAN may be restricted by the proprietor of the building or responsible representatives of the organization. Such restrictions may apply in environments where the risk of interference to other devices or services is perceived or identified as harmful.

If you are uncertain of the policy that applies to the use of wireless devices in a specific organization or environment, you are encouraged to ask for authorization to use the Wireless LAN device prior to turning on the equipment.



AC voltage: This symbol indicates that the rated voltage marked with the symbol is AC voltage.



This equipment is a Class II or double insulated electrical appliance. It has been designed in such a way that it does not require a safety connection to electrical earth.

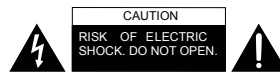

- This lightning flash with arrowhead symbol within an equilateral triangle is intended to alert the user to the presence of non-insulated "dangerous voltage" within the product's enclosure that may be of sufficient magnitude to constitute a risk of electric shock.
- Warning: To reduce the risk of electric shock, do not remove cover (or back) as there are no user serviceable parts inside. Refer servicing to qualified personnel.
- The exclamation point within an equilateral triangle is intended to alert the user to the presence of important operating and maintenance instructions in the literature accompanying the appliance.

Getting started

Accessories List

The following accessories are included with TV:

OWNER'S MANUAL × 1	Remote Control × 1	AAA Battery × 2
Base Stand Column × 2	Screw(M5×16) × 4	Screw(M4×8) × 4
Base Stand Panel × 1	RCA jack to AV Cable × 1	
Power Cord × 1 (only for 65")		

NOTE

- The accessories may be different from the list above due to different models, countries/regions, please refer to the actual accessory bag.

Installing the Stand or Wall Mount Bracket

CAUTION

- Be sure to disconnect the AC power cord before installing a stand or wall mount brackets.
- The display on your TV is fragile. Make sure the TV screen is not scratched or damaged by hard objects or from pressure.
- After the installation is complete, make sure the TV is steady on a table or firmly attached to a wall mount, before removing all protective film, if any.

Installing the Stand

- Carefully place your TV face-down on a soft, flat surface to prevent damage to the TV or scratching to the screen.
- Take out the Base Stand Columns from the accessory bag and then secure the columns to your TV with 4 screws(M5×16).

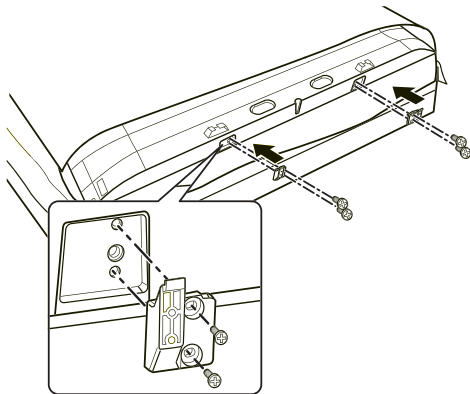

- Secure the Base Stand Panel to the Base Stand Columns with 4 screws(M4×8) in accessory tightly.

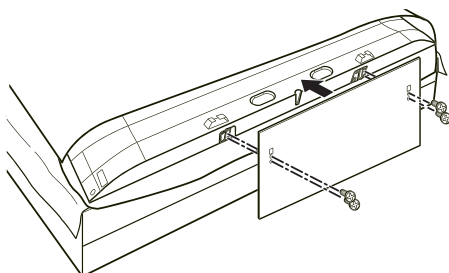

Installing the Wall Mount Bracket

Before mounting the TV, remove the TV stand if you have already attached it, and make sure the wall mount bracket supports the weight of your TV.

CAUTION

When mounting the TV on a wall, follow instructions provided with the wall mount bracket. If it is not correctly mounted, the TV may fall and cause property damage or personal injury.

- Place spacers between the TV and bracket.
- Make sure the tilt angle between the TV screen and the vertical surface is no more than 15 degrees.

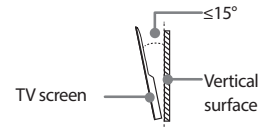

- Standard dimensions are shown below.

Wall mount hole pattern (mm)	400 × 200 (55") 400 × 400 (65")
Wall mount screw size	M6

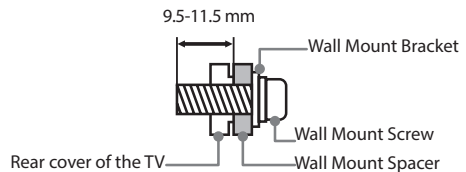

NOTE

- The diameter and length of the screws differ depending on the wall mount bracket model.
- Wall mount bracket is optional. Your TV may not have wall mount bracket. Please refer to the actual accessories.

Installing the P-Clip

The TV may fall back, please place the TV near the wall after the installation. Do not let children get close.

- Fix the P-Clip to the base stand by using the M4×6 screw.
- Secure the other side of P-Clip to the firm table by using the ST4×25C screw.

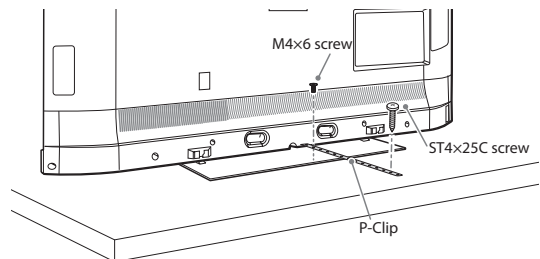





NOTE

- Insecure installation may cause the tilt or falling of the product, and further lead to personal injuries or product damages.
- P-clip and corresponding screws may not included with TV set, please purchase them by yourself if necessary.

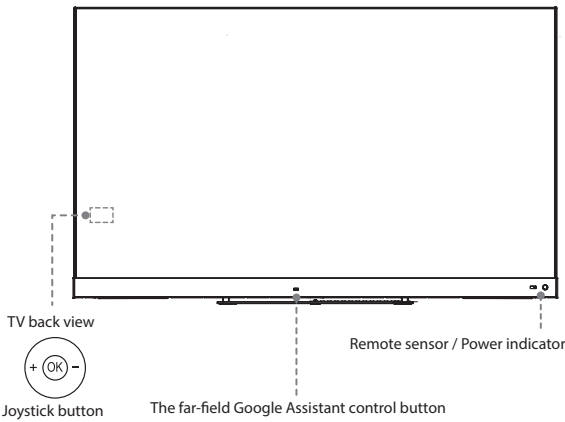
Getting started

TV Front

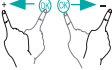

Item	Description
Remote sensor	Receive remote signals from the remote control. Do not put anything near the sensor, as its function may be affected.
Power indicator	The light is off when the TV is turned on. The light is red in standby mode.
The far-field Google Assistant control button	Switch the button to left to turn on the built-in microphone of far-field Google Assistant. Say "OK Google" to start a conversation. Before using this function, connect the TV to the Internet and sign in your Google account.
	Select among the different input signal sources or put the TV in standby mode, or you can turn on the TV when the TV in standby mode.
	Toggle the OK button left and right to adjust the volume.
	Toggle the OK button up and down to select the channel.

NOTE

- Powering on the TV requires several seconds to load program. Do not rapidly turn the TV off as it may cause the TV to work abnormally.
- The far-field Google Assistant and some of its features are only available in selected countries, regions and languages.

TV Rear

55"

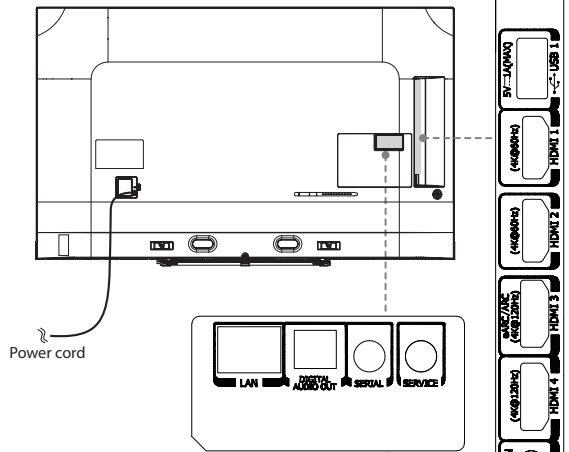

65"

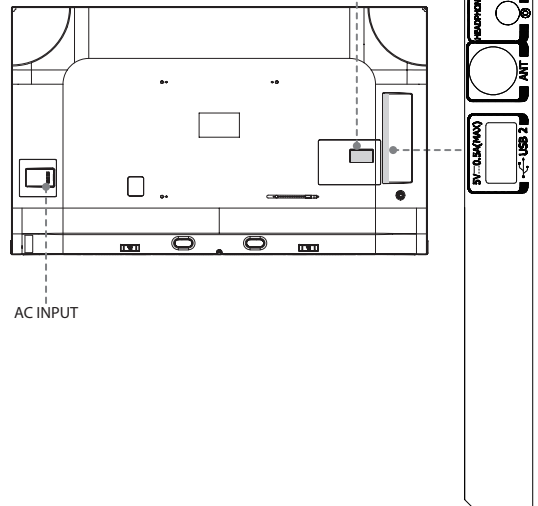











NOTE

- Check the jacks for position and type before making any connections. Loose connections can result in image or color problems. Make sure that all connections are tight and secure.
- Not all A/V devices have the ability to connect to a TV, please refer to the user's manual of your A/V device for compatibility and connections procedure.
- Before connecting external equipment, remove the mains plug from the wall socket. Otherwise, it may cause electric shock.

Getting started

Terminals

ANT		Connect an outdoor VHF/UHF antenna.
HDMI		Connect an HDMI cable from an external A/V equipment.
HDMI (eARC/ARC)		Connect an HDMI cable from an external digital audio system.
AV IN		Connect a composite video cable and left-right audio cables from an external AV device. The VIDEO can be used to connect a range of equipment, including video recorders, camcorders, decoders, satellite receivers, DVD players, or games consoles.
USB		Connect a USB device for browsing photos, music and movies.
DIGITAL AUDIO OUT		Connect an optical cable from an external digital audio system.
LAN		Connect an Ethernet cable to access a network or the Internet.
HEADPHONE		Connect headphones to listen to the sound coming from the TV. Note: Excessive sound pressure from earphones can cause hearing loss.
SERIAL		It may be used to connect to a home automation system or Custom Integrated Audio/Video (A/V) system. It is recommended that it only be completed by a professional custom installer.
SERVICE		This port is not available for you to connect an external device. It can only be used by our factory for testing purposes.

NOTE

- The location and names of the terminals on the TV may vary according to TV model, and not all terminals are available on all models.

Getting started

Establishing a Wired Internet Connection

Connecting to a wired (Ethernet) network

Press / / button to select icon, and select **Network & Internet**.

To get access to the Internet in a wired way, it is recommended to use a modem or router that supports Dynamic Host Configuration Protocol (DHCP). Modems and routers that support DHCP automatically provide the IP address, subnet mask, gateway, and DNS, so you don't have to enter them manually. Most home networks already have DHCP.

See the illustration below.

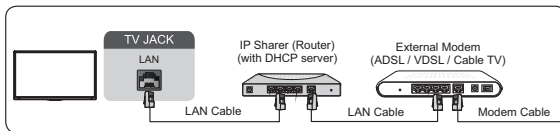

Using Wake on LAN

Press / / button to select icon, select **Network & Internet**, and set **Wake on LAN** and **Wake on Cast** to On.

Using an Ethernet connection and switching on Wake on LAN and Wake on Cast, you can turn on the TV from the standby mode, and push content to be broadcast on the TV with an app supporting the screencast feature in your mobile device.

NOTE

- To use this function, make sure your TV and mobile device are connected to the same network.
- Enabling this function may result in higher energy consumption.

Establishing a Wireless Internet Connection

Connecting to a wireless network

Press / / button to select icon, and select **Network & Internet > Wifi**.

To connect to an available wireless network, make sure that you have the wireless router's SSID and password before attempting to connect.

The TV's built-in Wireless LAN Adapter supports the IEEE802.11 ac/a/b/g/n communication protocols.

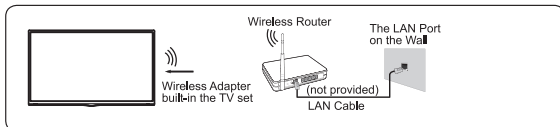

To get access to the Internet in a wireless way:

1. Turn on your Wi-Fi.
2. The list of networks will display automatically.
3. Select a wireless network from the list, input the password.
4. If the network connection does not appear in the list, select See all to display all the list, or select Add new network to input a Wi-Fi name, select the type of security mode, and enter password.

Using Wake on Wireless Network

Press / / button to select icon, select **Network & Internet**, and set **Wake on Wireless Network** and **Wake on Cast** to On.

Using a wireless network connection and switching on Wake on Wireless Network and Wake on Cast, you can turn on the TV from the standby mode, and push content to be broadcast on the TV with an app supporting the screencast feature in your mobile device.

NOTE

- To use this function, make sure your TV and mobile device are connected to the same network.
- Enabling this function may result in higher energy consumption.

Connecting Bluetooth Devices

Connecting a Bluetooth device

To pair a Bluetooth device, such as Bluetooth headphones, speakers, keyboards, mouse or even mobile devices:

1. Before pairing your Bluetooth devices, make sure they're in pairing mode and put devices within range of the TV. To put your Bluetooth devices in pairing mode, refer to the user manual of devices.
2. Press / / button to select icon, and select **Remotes & Accessories > Add accessory** to turn on the pairing mode.

A list of available Bluetooth devices will be displayed.

3. Select the desired device from the list, then follow the onscreen instructions.

If you are prompted to enter a passcode, refer to the instruction in user manual of the device.

After pairing is completed, the device is connected and is stored to the TV.

NOTE

- You need to unpair a paired device first if the maximum number of paired devices was reached.

Listening to the TV through Bluetooth devices

1. Pair the Bluetooth audio devices using the TV's Bluetooth function. Refer to the user manual of your audio device such as Bluetooth speaker, sound bar and headphones for detailed connection steps and usage.
2. Press / / button to select icon, select **Sound > Audio Output**, and then select the Bluetooth option to listen to the audio through bluetooth devices.

NOTE





- Compatibility issues may occur depending on the Bluetooth device.
- The TV and Bluetooth device may disconnect depending on the distance between them.

Getting started

Using HDMI&CEC





Use the TV's remote to control external devices that are connected to the TV by an HDMI cable. The external devices need to support HDMI&CEC function.

Connecting an external device through HDMI&CEC function

Press  /  /  button to select  icon, and select **Device Preferences > Inputs > HDMI control**.





1. Set **HDMI control** to On.
2. Connect an HDMI&CEC compliant device to the TV.
3. Turn on the connected external device. The device will be connected to the TV automatically. After connection is finished, you can access the menu of the connected device on your TV screen using your TV remote and control the device.

Enabling device auto power off

Press  /  /  button to select  icon, and select **Device Preferences > Inputs > Device auto power off**.



Set to On to turn off CEC compatible external devices when the TV is turned off.

Enabling TV auto power on

Press  /  /  button to select  icon, and select **Device Preferences > Inputs > TV auto power on**.

Set to On to turn on the TV when CEC compatible external devices are turned on.

Using HDMI 2.0 Format function

Press **INPUT** button on your remote to select **HDMI**, and then press  /  button to select **HDMI 2.0 Format**.

Please select the Enhanced format if your HDMI device supports 4K HDR and above. If it does not support 4K HDR, please select Standard format.

NOTE

- HDMI cables must be used to connect HDMI&CEC compatible devices to your TV.
- The HDMI&CEC feature of the connected device must be turned on.
- If you connect an HDMI device that is not HDMI&CEC compatible, all the HDMI&CEC control features do not work.
- Depending on the connected HDMI device, the HDMI&CEC control feature may not work.
- The HDMI&CEC feature supports One Touch Play, Routing Control, System Standby, Device OSD Name Transfer, Remote Control Pass Through, Give Device Power Status, System Audio Control.



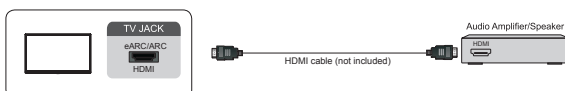

Connecting a Digital Audio System to Use eARC/ARC

If you'd like to use the Enhanced Audio Return Channel (eARC) / the Audio Return Channel (ARC) feature to send sound from the TV back down an HDMI cable to a digital sound system, you can connect it to the HDMI (eARC/ARC) port of your TV.



By using this feature, you can also control the sound system with your TV remote instead of using the remotes for each device.

After the connection:

1. Power on the sound system.
2. Press  /  /  button to select  icon, and select **Sound > Audio Output > eARC/ARC**.

If the device support eARC function, first select **Sound > eARC** to set it to On.

NOTE

- It works only when the TV is connected to the audio receiver that supports the eARC/ARC function.
- If the device has an Input Selector feature then make sure to change it to TV.
- When this port is used for eARC/ARC function, it can be used as signal input when DVD is connected to an amplifier and the amplifier is connected to the TV at the same time. (Some amplifiers may not support series connection.)

Connecting an AV device, a PC or a Game Console with an HDMI cable

You can connect an AV device, a PC or a Game Console with an HDMI cable.

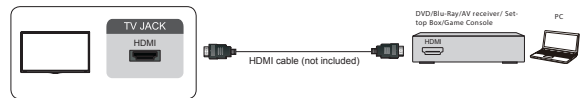

After the connection:

1. Power on the device.
2. Press **INPUT** button on your remote, select the corresponding HDMI as the input source.

NOTE

- Some devices such as DVD player require HDMI signal to be set to output in the device's settings. Please consult your device's user manual for instructions.
- If there is no sound from your TV, change the device's audio settings.

Connecting with an USB Cable

Connect the USB devices such as hard drives, USB sticks and digital cameras for browsing photos, listening to music.

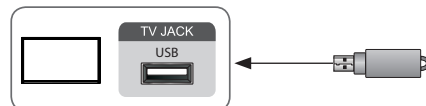

- Support the U disk 4G, 8G, 16G, 32G, 64G, 128G and other common market size, and 8T hard drive is currently supported.
- Support format: NTFS, FAT32, EXT4.

Getting started

Using the USB storage device function

The USB storage device function can be used to record and view digital broadcast programmes.

Read the precautions below before recording or viewing programmes using the USB storage device function.

NOTE

- Be sure to select the correct country/region for use.
Use of the recording function may not be possible depending on the selected country/region.
Use with incorrect settings may violate certain laws or other regulations, and may result in criminal punishment.
In such cases, TOSHIBA CORPORATION and the Toshiba Group shall bear no responsibility whatsoever.
- Recorded programmes saved on the USB storage device can only be viewed on this TV. They cannot be viewed when connected to another TV (including the same model of TV), a PC, or other device.
- You cannot watch one channel while recording another.
- If the recording time to the USB storage device is too short, no data may be saved.
- You cannot record video input signals on the USB device.
- Not all types of broadcast may be recordable.
- After programming the TV to record digital broadcasting, do not disconnect the power plug before recording starts.
- Should video or audio recording fail due to malfunction of the TV or poor reception, no compensation shall be paid.
- Certain digital cameras may not be compatible with the TV.

Remote Control

Buttons on the Remote Control



- ① POWER: Turn the TV on or into standby mode
- ② : Select input source
- ③ 0-9: Direct channel selection or numbers input
- ④ TEXT: Turn on/off the teletext function
- ⑤ TV: Enter the Live TV in the Home screen (TV mode)
- ⑥ Special function buttons
- ⑦ : Display the current programme information
- ⑧ : Display the quick setup menu
- ⑨ OK / Confirmation button
- ⑩ D-pad: Allow you to navigate the OSD menus and adjust the system settings to your preference
- ⑪ Back: Return to previous menu
- ⑫ GUIDE: Display the Electronic Programme Guide (DTV mode)
- ⑬ Google Assistant of TV
- ⑭ + / -: Adjust the volume
- ⑮ P / : Switch channel
- ⑯ : Display the Home screen
- ⑰ PVR: Record the current program (DTV mode)
- ⑱ SUBTITLE: Press to display the Subtitle Language menu
- ⑲ : Mute or restore the TV sound
- ⑳ S.MODE: Select the sound mode
- ㉑ P.MODE: Select the picture mode
- ㉒ : Media content control function buttons
- ㉓ APPS: Fast access to applications
- ㉔ MEDIA: Enter the media
- ㉕ : Fast access to all applications

NOTE

The included remote control will vary depending on model, country/region. Check information according to the actual remote control in the accessory bag.

Remote Control



- ① POWER: Turn the TV on or into standby mode
- ② : Select input source
- ③ 0-9: Direct channel selection or numbers input
- ④ TEXT: Turn on/off the teletext function
- ⑤ TV: Enter the Live TV in the Home screen (TV mode)
- ⑥ Special function buttons
- ⑦ : Display the current programme information
- ⑧ : Display the quick setup menu
- ⑨ OK / Confirmation button
- ⑩ D-pad: Allow you to navigate the OSD menus and adjust the system settings to your preference
- ⑪ Back: Return to previous menu
- ⑫ GUIDE: Display the Electronic Programme Guide (DTV mode)
- ⑬ Google Assistant of TV
- ⑭ + / -: Adjust the volume
- ⑮ P / V: Switch channel
- ⑯ : Display the Home screen
- ⑰ PVR: Record the current program (DTV mode)
- ⑱ SUBTITLE: Press to display the Subtitle Language menu
- ⑲ : Mute or restore the TV sound
- ⑳ AD: Set the Audio Description on or off
- ㉑ P.MODE: Select the picture mode
- ㉒ : Media content control function buttons
- ㉓ APPS: Fast access to applications
- ㉔ MEDIA: Enter the media
- ㉕ : Fast access to all applications

NOTE

The included remote control will vary depending on model, country/region. Check information according to the actual remote control in the accessory bag.

Remote Control

Installing Batteries in the Remote Control

Press the release button on the back of the remote control to remove the battery compartment cover.

1. Slide the back cover to open the battery compartment of the remote control.
2. Insert two AAA size batteries. Make sure to match the (+) and (-) ends of the batteries with the (+) and (-) ends indicated in the battery compartment.
3. Close the battery compartment cover.

- ❶ Gently push and slide

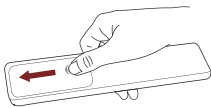

- ❷ Insert the batteries

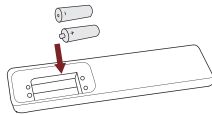

- ❸ Gently push and slide

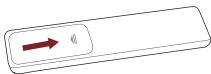

NOTE

- Product image is only for reference, actual product may vary in appearance.

Handling the Batteries

- Incorrect use of batteries may cause corrosion or battery leakage, which could cause fire, personal injury or damage to property.
- Only use the battery type indicated in this manual.
- Do not mix old and new batteries or different types of batteries.
- Do not dispose of used batteries as domestic waste. Dispose of them in accordance with local regulations.
- Battery chemicals can cause a rash. If the batteries leak, clean the battery compartment with a cloth. If chemicals touch your skin, wash immediately.
- If you do not intend to use the remote control for a long time, remove the batteries.
- Remove depleted batteries immediately to prevent battery acid from leaking into the battery compartment.

Pairing the Remote Control

1. Pair the remote to the TV after you power it on. Make sure your remote is close to this TV around 3 meters. Press and hold the [] button at least 3 seconds to start pairing.
2. If the remote pairs successfully, a confirmation will display on the screen. If it does not pair successfully, an unsuccessful message will display. Repeat step 1.

NOTE

- This function is only available on certain models and bluetooth remote control in some countries/regions.
- If an unknown error occurred with the remote then it could have been caused by interference. Try to remove what's causing the interference and pair it again.

- If an unknown error occurred in the remote control while the battery power is normal, you can take out the batteries and press any key for 1~2 seconds, then the remote control can work normally.
- The remote cannot be paired to the TV while the TV is in standby mode.

Remote Control Operation Range

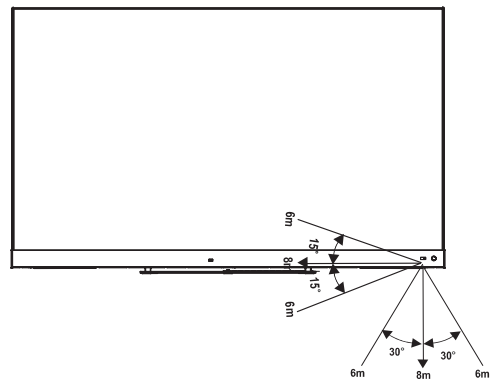

Channel Scan

Auto Scan

INPUT > Channels

If no TV channels were saved before, you will be prompted to do a channel search.

or

In Live TV, / / > Channels > Auto Scan

Automatically scan for channels to view programmes from your TV source.

Manual Scan

In Live TV, / / > Channels > Advanced Settings

- **DTV Manual Scan**
Manually scan for programmes in digital signals.
- **ATV Manual Scan**
Manually scan for programmes in analogue signals.

Channel Edit

In Live TV, / / > Channels > Channel Edit
Manually edit the channel list order to your preference.

Editing channels

Press button on the selected channel then a checkbox will appear. You can select multiple channels at the same time to move or delete.

- Delete: Press button to delete the selected channel.
- Move: Press button to move the selected channel.

NOTE

- Moving the channels could be restricted in some models/countries/regions.
- If channel scan has LCN option, LCN should be set to Off.
- Restore: Press **R/G/Y/B** / / button to call out the four-color menu to select the **RED** icon or press the **RED** button to enter the list of deleted channels. Press button to restore the deleted channel.
- **123** Go to: Select a channel by selecting the position number in this list.



Edit the channels

Editing favourite channels

You can add, move, and delete favourite channels.

Exporting to USB

Allow you to export the current channel list to a USB storage device.

Importing from USB

Allow you to import a previously exported channel list via a USB storage device.

Channel List

Displaying the channel list

In Live TV, press or button on the remote to display the Channel List menu.

Entering the sub-menu of channel list

or >

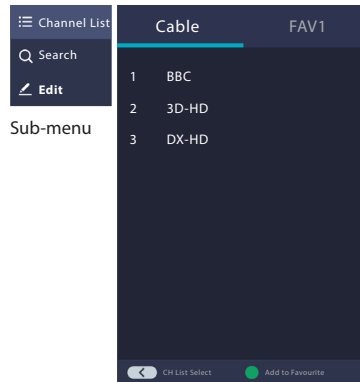

Channel list menu

Introducing the sub-menu

1. Channel List

or > > Channel List

▪ All

Display the channels that have been automatically searched.

▪ Favourite List

Display favourite lists 1 to 4. (Four favourite lists at most can be added).

▪ Add fav list

Add an additional favourite list.

2. Search

Quick access to channels.

3. Edit

Edit the channel list.

Favourite

Viewing your favourite list

Press **ok** or **GUIDE** button to call out the Channel list, and the channel list appears on the right side of the screen.

A heart-shaped icon will appear next to your favourite channel.

Editing the favourite list

There are 2 ways to enter the edit menu:

ok or **GUIDE** > **<** > **Edit** > **Favourite1-Favourite 4**
or

≡ / **≡** / **≡** > **Menu** > **Channels** > **Channel Edit** > **Favourite1-Favourite 4**

The Edit Favourites screen appears.

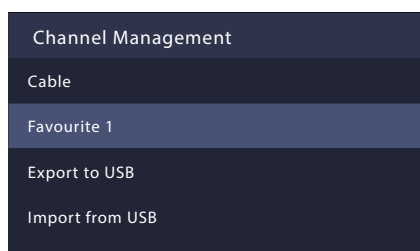

- **Adding channels to a favourite list**

Select the **+** **Add channels** to add the selected channel to the favourite list.

- **Moving channels in a favourite list**

Select a channel in a favourite list, press **<** button to move it.

- **Deleting channels from a favourite list**

Select a channel in a favourite list, press **>** button to remove it.

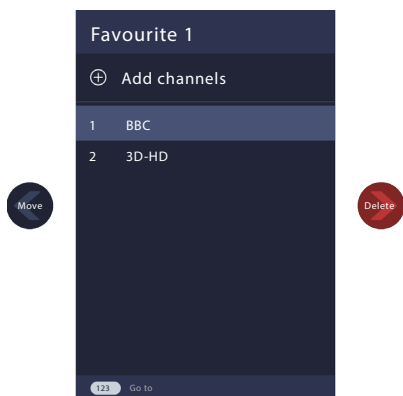

NOTE

- These steps should be operated under Channels inputs.
- Before you edit the favourite lists, complete channel scan first.
- You can add channels from various reception types to the favourite list.

EPG (GUIDE)

It provides convenience to check TV programmes that will be available

in the next 7 days. The information displayed by the EPG (GUIDE) is made available by the commercial television networks for digital channels only. The EPG (GUIDE) also provides a simple way to record your favourite programmes and a reminder function which can switch channel automatically at scheduled time so that you will not miss programmes of interest.

(The availability and amount of programme information will vary, depending on the particular broadcaster).

NOTE

The EPG (GUIDE) function is only available for digital channels. Analogue channels are not supported.

In Live TV, press **EPG** / **GUIDE** button on the remote or press **≡** / **≡** / **≡** button to enter the Menu, then choose the **EPG (GUIDE)** to display channel information on programme guide list.

- **Watch**

When a current programme is selected, press the **ok** button to switch to the channel you want to see.

- **PVR/Reminder**

Press **▲** / **▼** button to select the channels. Press **<** / **>** button to select programme based on the time schedule.

Press **ok** button on the remote to select PVR or Reminder.

NOTE

- PVR/Reminder in the Guide(EPG) is only available for programmes that haven't been aired yet.
- A storage device (space should be no less than 2G, transfer rate should be no less than 5MB/s) must be attached to the television for recording purposes. It is strongly recommended to use USB mobile hard disk drive instead of USB flash drive as the storage device.
- The TV will record the programme even in standby mode.
- The PVR function may not be applicable in some models/countries/regions.

- **Page Up/Down**

Press **CHA** / **CHV** button to move the programme list page up/down.

- **Schedule**

To view a list of scheduled reminders and recordings.

Press **R/G/Y/B** / **⊕** / **123** button on the remote to call out the colour menu to select the **RED** icon or press the **RED** button on the remote directly according to the actual remote in the accessory bag.

- **Detail**

To display details of the selected programme.

Press **R/G/Y/B** / **⊕** / **123** button on the remote to call out the colour menu, select the **GREEN** icon or press the **GREEN** button on the remote directly according to the actual remote in the accessory bag.

This function may not be applicable in some models/countries/regions

- **24-**

To select programmes of the previous day.

Press **R/G/Y/B** / **⊕** / **123** button on the remote to call out the colour menu, select the **YELLOW** icon or press the **YELLOW** button on the remote directly according to the actual remote in the accessory bag.

- **24+**

To select programmes of the next day.

Live TV

Press **R/G/Y/B** / **+** / **123** button on the remote to call out the colour menu, select the **BLUE** icon or press the **BLUE** button on the remote directly according to the actual remote in the accessory bag.

PVR

The PVR function allows you to easily record digital television content for later viewing. The function is only available for digital channels. To use PVR, you must connect a USB device for recording. The format of the storage disk should be NTFS, FAT32. The PVR will not function if a data storage device has not been connected.

Schedule Recording

Press **EPG** / **GUIDE** button or press **≡** / **≡** / **≡** button on your remote to access the **Menu**, and then select **EPG (GUIDE)**.

Select the upcoming programme, press **ok** button to select **PVR** and set the appointment time and period. The reservation is successful.

Press the **RED** button or press **R/G/Y/B** / **+** / **123** button on the remote to call out the colour menu, then select the **RED** icon to view the scheduled recording. In the schedule recording list, you can readjust the reservation information that has been set.

Instant Recording

Press **V** button to select PVR.

Select a USB storage drive, the device speed will be tested if it is used for the first time.

You can manually stop recording or choose to automatically match the programme time.

Standby Recording

If you press the power button during recording, a pop-up window appears on the screen. Select **Standby Recording**, and the TV will go into standby mode but the recording process is still going on. If you press power button again to wake up the TV, the recording process will not be affected. After recording, the recorded file will be automatically saved to the disk.

Background Recording

You can switch to an app or another source (e.g. HDMI) during recording, a pop-up window appears on the screen. Select **Yes** to switch, and the recording process is still going on. When the recording is done, the recorded file will be automatically saved to the disk. If you want to manually stop recording, press **INPUT** > **Channels** to switch back to the channel that is in the recording process, and then press **V** > **ok** button to stop.

NOTE

- The storage space of your USB device should be no less than 2G (for 15 minutes high definition video). It is strongly recommended to use USB mobile hard disk drive instead of USB flash drive as the storage device.
- If the transfer rate of your hard disk is too slow, a pop-up notice will appear. In this case, you can use another disk with higher speed.
- The PVR function doesn't support analogue channels.
- The schedule recording function is not available while you are watching a programme that is currently being broadcast.
- Some broadcasters may restrict to record the programme.

- During the recording progress, channels locked with Channel Lock (password needed) are disabled to watch.
- The PVR function may not be applicable in some models/countries/regions.

Recording List

Accessing the recording list

View the list of recorded programmes and scheduled recordings.

To enter the recording list:

V > **Recording List**

or

In **EPG (GUIDE)**, Press the **RED** button or press **R/G/Y/B** / **+** / **123** to select **RED** icon, and then select **Recorded**.

Managing the recording list

V > **Recording List** > **Recorded**

You can watch or delete recorded programmes.

Delete the recorded programme

Select **Edit**, select a recorded programme in the recording list, and press **➔** button to remove it.

Watch

Select a recorded programme in the recording list, and press **ok** button to watch it.

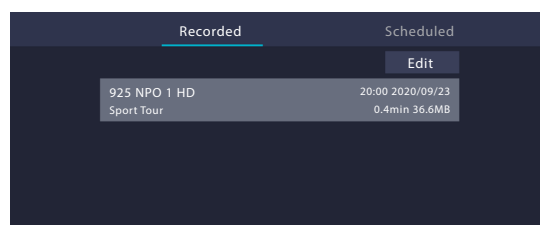

Managing the schedule recording list

V > **Recording List** > **Scheduled**

You can change scheduled recording information or cancel scheduled recordings.

Delete the scheduled programme

Select **Edit**, select a scheduled programme in schedule list, and press **➔** button to remove it.

Edit scheduled programme

Select a scheduled programme in schedule list, press **ok** button to adjust the scheduled programme.

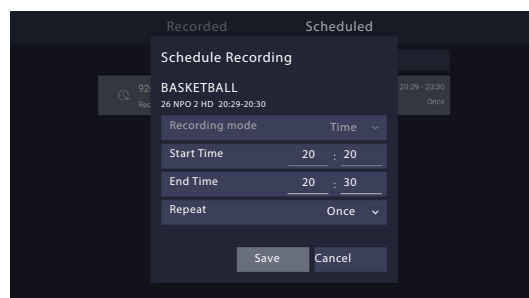

NOTE

- The Recording List function is only applicable in some models/countries/regions.

Timeshift

This option allows you to pause and rewind live TV. This function operates by recording temporarily to a storage device. Please ensure your storage device is connected and there is enough free disk space. Otherwise the recording will not commence.

Press **V** button on the remote to select T.Shift and then the menu will appear, select the **||** icon to pause the live broadcast and select the **▶** icon to play. Select the **◀◀** icon to rewind and select the **▶▶** icon to fast forward. Select the **■** icon to exit the function and watch the current broadcast.



1. Rewind time
2. Rewind
3. Pause / Play
4. Fast forward
5. Stop Timeshift
6. Current time
7. Total time

NOTE

- The T.Shift function doesn't support analogue channels.
- The storage space of the USB device should be no less than 1G. It is strongly recommended to use USB mobile hard disk drive instead of USB flash drive as the storage device.
- The Timeshift function may not be applicable in some models/countries/regions.

Multi-screen

Screen Sharing

Mirror content from your mobile device to the TV. View videos, photos and more from your device on your TV screen.

 /  /  > **Apps** > **Screen Sharing**

- Turn on the casting function of your Android/Windows10 device.
The setting icon may vary depending on the device. The feature may be called "Wireless display", "Smart view", "Wireless projection", etc.
- Find the TV name in the searching list of your device and select it.
Wait for the connection progress to complete and the content on your device will be displayed on the TV.

NOTE

- Some mobile devices may not support casting.

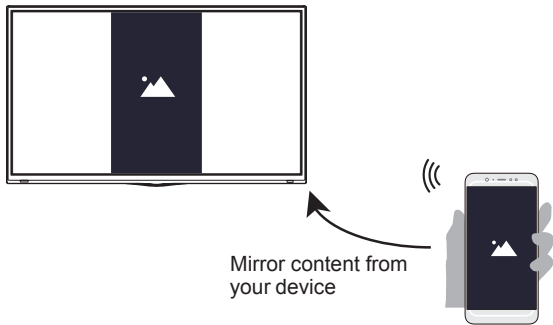

Content Sharing

Share videos, music or pictures from your Android/iOS/PC device to the TV screen.

Press  /  /  button to select  icon, select **Network & Internet**, and select **Content Sharing**.

- Turn on the contents sharing function of your Android/iOS/PC device.
- Find the TV name in the searching list of your device and select it.
Wait for the connection progress to complete and select the content you want to share.

NOTE



- TV and your Android/iOS/PC device need to connect to the same network.
- Some devices may not support contents sharing function. If your device doesn't support contents sharing, you can download an app that supports the function.



Smart Functions

Getting Familiar with the Home Screen

The simple design of the Home screen menu makes it easy to navigate. And you can easily add or delete applications in the Home interface according to your needs.

To access the Home screen, press the  /  /  button on your remote and use the D-pad to make your selection.

To exit the Home screen, press **INPUT** button on your remote or use the D-pad to move the cursor to  Inputs icon on the top of the screen, press  button to enter, and select your desired input source.

Indicators and icons on the top of the Home screen

- **Google Assistant**
You can search movies, adjust volume, and more by speaking.
- **Google Search**
You can search movies, adjust volume, and more by typing.
- **Notifications**
Notifications can come from the system, an external device, an application, the media player, etc.
- **Inputs**
Select the Input source depending on the device you have connected to your TV.
- **Network & Internet**
You can set up the Network & Internet.
- **Settings**
Settings lets you configure the TV, set app options, add accounts, and change other preferences.
- **Time**
You can always view the current time on the Home screen.

Names of sections that appear on the Home screen

The Home screen displays the following section:

- **Apps**
This is the location where you have access to all the apps on your TV. You can enjoy a wide range of services including video streaming.
- **Play Next**
You can select types of content for play next.
You can also manually add a programme to play next by long-pressing on a programme in the Home screen.
- **Recommended content**
Here the premium content will display on the screen, and you can quickly enter contents that you want.

Managing apps on the apps row

Select an app on the apps row you want to open, remove or move, and long press  button to manage.

If the favourite app is not on Home screen, you can add app to the apps row via the Apps page. Select your favourite app and long press  button, and then select **Add to favourites**.



Apps

 /  /  > **Apps**

Numerous factory-installed apps are available for you to choose for your entertainment preferences.

Installing an app

To install an app:

1.  /  /  > **Apps** > **Get more apps** > **Google Play**.
2. Use the navigation buttons on your remote to select the app that you want to install.
3. Select the **Install**. The selected app is installed on the TV.

 **NOTE**



- To use this function, the TV must be connected to the Internet.
- Adding apps is free, but it might cost you money when using some apps.

Managing installed apps

Removing an app

You can only delete apps that you've installed to the TV. Factory-installed apps can not be deleted.

To delete an app:



1. From the Apps screen, use the navigation buttons on your remote to select the app that you want to remove. Long press the  button.
2. Select **Uninstall**.
3. A dialogue message displays and asks whether you want to uninstall this app. Press the  button to confirm and the icon is removed from the apps screen.

 **NOTE**

- If an app is deleted, the information related to that app is also removed.

Moving app icons around

To move an app:

1. From the apps screen, use the navigation buttons on your remote to select the app that you want to move. Long press the  button.
2. Select **Move**.
3. Use the navigation buttons on your remote to move the location of app. Press the  button to confirm.

Smart Functions

Using Far-Field Google Assistant to Control your TV

The Google Assistant can answer your questions or help you change TV configuration.

Before using this function, connect the TV to the Internet and sign in your Google account.

Select  icon on the top of Home screen and follow the onscreen instructions to complete sign in.





How to use the Google Assistant function via the control button on the TV

1. Turn on the build-in microphone of far-field Google Assistant on the TV.
2. Start a conversation by saying "OK Google" or "Hey Google", and the dialogue bar appears at the bottom of the TV screen. At the same time, indicator lights illuminate.
3. Continue speaking, such as "What's the weather" or "Volume up".

Screenless Mode

You can talk to the Google Assistant even when the screen is off.

In Screenless Mode, the Google Assistant is always available to help even when the screen is not on. Just say "OK Google" or "Hey Google" to start a conversation.

This feature will affect standby power consumption. To turn it off, go to  /  /  button to select  icon, and select **Advanced System > Support > Screenless Mode**.

NOTE





- The far-field Google Assistant and some of its features are only available in selected countries, regions and languages.

Installing Mobile App to Control your TV

Press  /  /  button to select  icon, and select **Advanced System > Mobile App Installation**.

You can scan the Mobile App download QR code on screen to install the app on your smartphone to control your TV, such as turning the TV on or off, typing in with your mobile's keyboard, and sharing pictures or videos from your mobile to TV. This app is available on both Android and iOS.

To connect your TV after installing the mobile app

1. Agree with end user license, and disclaimer and privacy policies on TV. If you are not sure whether you have agreed, press  /  /  button to select  icon, and select **Device Preferences > About > Legal information > End User License Agreement/EULA & Privacy** to check it.
2. Make sure your mobile phone and TV are connected in the same network.
3. To use this function, switch on **Content Sharing at Network & Internet > Content Sharing**.
4. Open the mobile app and select the TV device you want to connect.
5. Enter the PIN code on the mobile phone, and the connection is established.



Media

Media is a central location for you to view or listen to different types of content, such as photos, music and movies. You can view media content through the following methods:

- A USB thumb drive or hard drive
- Compatible mobile phone, tablet or other personal devices: you can stream movies, music and photos that are stored on compatible personal device and play or view the content on your TV.

Browsing content

You have two ways to enter Media:

- Insert a USB device, a prompt message appears, choose whether to go to the media.
- When your USB device is connected to the TV but TV doesn't show Media page, press  /  /  button to select **Apps > Media**.

To browse content based on the type that you wish to access:

1. Navigate to the appropriate menu tab on the screen and select **All Media, Videos, Photos, Music**.
2. Click on the name of the folder that contains your content.
3. Make your selection to play or view the content.





To exit the Media centre, press the  /  button on your remote.

You must obtain any required permission from copyright owners to download or use copyrighted content. TOSHIBA cannot and does not grant such permission.

Picture and Sound

Adjusting the Picture Quality

Using the backlight function

Press  /  /  button to select  icon, and select **Picture > Backlight**.





You can change the overall brightness of the screen.

- **Local Dimming**
Enable the TV to automatically adjust the backlight by sections according to the changes in the image and increase the contrast.
- **Dynamic Backlight Control**
Enhance the contrast ratio between light and dark areas of the picture.
- **Backlight Level**
Adjust how bright you want images to appear, lower settings create darker images.
- **Automatic Light Sensor**
Enable the TV to automatically adjust the picture settings according to the amount of ambient light in your room.
- **Light Sensor Shift**
Adjust the lower point of the dynamic backlight adjustment scope. This is a money-saving feature because it reduces power consumption.

NOTE

- Some functions above may not be applicable in some models/countries/regions.

Adjusting peaking brightness dynamic range





Press  /  /  button to select  icon, and select **Picture > Peaking Brightness Dynamic Range**.

Adjust the maximum brightness of the screen area.

NOTE





- This function may not be applicable in some models/countries/regions.

Choosing a picture mode

Press  /  /  button to select  icon, and select **Picture > Picture Mode**.

You can select the picture mode that provides the best viewing experience.

Adjusting the picture quality for each picture mode





Press  /  /  button to select  icon, and select **Picture > Contrast, Brightness, Colour, Tint or Sharpness**.

Choose a picture mode and then adjust the settings.

- **Contrast**
Adjust the Contrast level to increase or decrease how bright images appear.
- **Brightness**
Adjust the Brightness level to generate lighter or darker images.
- **Colour**
Adjust the colour intensity of the picture for a more vibrant image.

- **Tint**
Adjust the colours from green to magenta tint to view the natural skin tones of people on the screen.
- **Sharpness**
Adjust how sharp or soft edges of images appear.

Changing the aspect ratio

Press  /  /  button to select  icon, and select **Picture > Aspect Ratio**.

You can change the size of the picture displayed on the TV screen.

- **Automatic**
Automatically switch Aspect Ratio between 16:9 and 4:3 based on the signal information.
- **16:9**
Best suited for 16:9 Widescreen content. This will also stretch 4:3 content to Widescreen.
- **4:3**
Best suited for 4:3 content.
- **Panoramic**
Provides a full-screen image by stretching the edges whilst leaving the middle untouched.
- **Movie Zoom**
Provides a full-screen image by zooming in on the movie.
- **Direct**
Point to point display also known as 1:1 Pixel Mapping.

NOTE

- Using the special functions to change the size of the displayed image (e.g. changing the height/width ratio) for the purpose of public display or commercial gain may infringe on copyright laws.
- If the aspect ratio of the selected format is different from the one of the TV transmission or video programme, it can cause a difference in vision.
- When using PC connected via HDMI terminal, the moving image quality may be deteriorated.

Enabling smart scene function





Press  /  /  button to select  icon, and select **Picture > Smart Scene**.

Set to On to enable your TV to recognize the scene in the content watching and enhance the picture quality on all input sources.

NOTE

- Some specific application has explicit constraints that the content recognition is not allowed.

Configuring advanced picture settings

Press  /  /  button to select  icon, and select **Picture > Advanced Settings**.

You can configure picture mode settings that provides the best viewing experience.

- **Overscan**
Change the video size settings to slightly crop the edges of the displayed image.

Picture and Sound

- **Colour Temperature**

Adjust how warm (red) or cool (blue) the white areas of an image appears.

- **Motion Enhancement**

Reduce seeing afterimages that are left on the screen when viewing fast-moving objects.

If you select **Custom**, you can configure **Blur Reduction** and **Judder Reduction** manually.

- **Motion Clearness**

Improve the clarity when viewing fast moving scenes.

- **Noise Reduction**

Improve how clear the picture appears by reducing noise.

- **Digital Noise Reduction**

Improve picture clarity by reducing video noise.

- **HDMI Dynamic Range**

Adjust the HDMI signal range to be more suitable for the content. (HDMI mode only)

- **Active Contrast**

Automatically darken dark areas and lighten light areas of images to see more details.

- **FILMMAKER MODE Auto Detect**

If it is set to on, picture mode will automatically be changed to FILMMAKER MODE when a signal that is compatible with FILMMAKER MODE is entered.

 NOTE

- FILMMAKER MODE is certified by UHD Alliance.
- With FILMMAKER MODE enabled, brightness of your TV will be automatically reduced.

- **Colour Space**

Change the range of colours the TV displays.

- **Instant Game Response**

Enjoy a low latency experience with external device (e.g. Xbox, PS5) connected to the TV when playing games.

Set to Auto to identify and enter a low latency experience automatically when switching between game and non game.

- **FreeSync**





Enjoy a smooth viewing experience by eliminating screen tearing and stuttering when FreeSync is turned on.

Be sure to set this function only for the external devices that support the AMD Radeon FreeSync feature.

 NOTE

- Some functions above may not be applicable in some models/countries/regions.

Configuring calibration settings

Press  /  /  button to select  icon, and select **Picture > Calibration Settings**.

Adjust the colour space and Gamma to best suit the content you're viewing.

- **Colour Tune**

Adjust the Hue, Saturation and Brightness of colour settings.

- **White Balance**

Adjust the intensity of red, green and blue lights to view the true colours of all images in the picture.

- **Gamma**

Adjust the Gamma to alter how the TV will respond to the grayscale content. In a dark room choose a Higher number like 2.4. In a brighter area select a Lower number like 2.0. In general, 2.2 is normally recommended.

- **Gamma Calibration**

Adjust selected Gamma curve.

- **RGB Only**

View images based on default settings or choose the colour red, blue or green.

 NOTE

- Some functions above may not be applicable in some models/countries/regions.

Enabling low blue light function

Press  /  /  button to select  icon, and select **Picture > Low Blue Light**.

Eye care: reduce the emission of blue light.

 NOTE

- This function may not be applicable in some models/countries/regions.

Applying the current picture settings to other input sources

Press  /  /  button to select  icon, and select **Picture > Apply Picture Settings**.

Apply current picture mode to all sources or just current source.

Sources include both external devices and OTT (Over the Top) sources.

Resetting the picture settings





Press  /  /  button to select  icon, and select **Picture > Reset**.

Reset current picture settings back to the factory setting.

Picture and Sound

Adjusting the Sound Quality

Enabling system sounds

Press  /  /  button to select  icon, and select **Sound > System Sounds**.

Set to On to open the default system sound.

Choosing a sound mode

Press  /  /  button to select  icon, and select **Sound > Sound Mode**.





You can select a preset sound mode suitable for the content type or the listening environment.

Selecting speakers





Press  /  /  button to select  icon, and select **Sound > Audio Output**.

Select the speakers that you want to have audio output.

Enabling eARC

Press  /  /  button to select  icon, and select **Sound > eARC**. Connect an audio device that supports eARC via HDMI-eARC, and set eARC to On to enjoy premium sound quality.

Enabling TV speaker

Press  /  /  button to select  icon, and select **Sound > TV Speaker**.

Turn on or off the TV speaker.

If ARC or Bluetooth is selected in Audio Output, configuration here is unavailable.

Setting sound mode

Press  /  /  button to select  icon, and select **Sound > DTS Height Virtualization/DTS Clear Dialogue/DTS Bass Enhancement/DTS Loudness Control/Subwoofer/Bass Boost/Dolby Atmos/TotalSonics™/TotalSurround™/TotalVolume™/ Wall Mount Setup**.

- **DTS Height Virtualization**
Experience immersive audio from as few as two channels of audio with virtual height and multi-channel virtual surround.
- **DTS Clear Dialogue**
Improve dialogue clarity to better hear what is being said, even in dramatic action scenes with sound effects.
- **DTS Bass Enhancement**
Extend low bass frequency performance of small speakers to deliver a rich listening experience.
- **DTS Loudness Control**
Automatic control over drastic volume changes while watching TV programmes or movies, providing a more comfortable and consistent volume.
- **Subwoofer**
Built-in subwoofer switch.
- **Bass Boost**
Built-in bass adjustment.

- **Dolby Atmos**
Set Dolby Atmos to On to enhance the richness of sound, and you can enjoy an immersive listening experience.

- **TotalSonics™**
Optimize overall sound quality by increasing bass, making dialogue clear and natural, and widening the sound field.

- **TotalSurround™**
Provide surround sound experience with psycho-acoustic processing to place sounds beside, behind, and above the viewer. For best results use with Total Sonics.





- **TotalVolume™**
Maintain consistent loudness levels from wide dynamic range programmes, loud commercials, and channel or input changes.

- **Wall Mount Setup**
Automatically optimize the sound based on the position of the TV.

NOTE

- Some functions above may not be applicable in some models/countries/regions.

Configuring advanced sound settings

Press  /  /  button to select  icon, and select **Sound > Advanced Settings**.

Tune the audio settings and quality of the TV.

- **Balance**
Adjust the left and right speaker strength to optimize audio for a specific location.

- **Volume Level**
Under the same volume output with the remote, the volume output can be adjusted independently for each signal source.

- **Auto Volume Control**
Activate to prevent the volume from changing when you switch TV channels.

- **Digital Audio Output**
Select the digital audio output format that best suits the audio device type.

NOTE

- When using optical connection, PCM and Dolby Digital are suggested.
- If your external audio device does not support Dolby or DTS, PCM is suggested.

- **Digital Audio Delay**
Adjust the digital audio output delay time to sync sound from an external speaker with the images on the TV.

NOTE

- Digital Audio Out and Digital Audio Delay functions are only applicable when Audio Output is set to ARC or when external audio players are connected via DIGITAL AUDIO OUT jack.

- **Lip Sync**
Synchronize the displayed image with the audio output.

- **Equalizer**
Boost the volume at different frequencies.

Picture and Sound

- **Headphone Mode**

Change the way how audio is sent through the type of device that's connected to your TV Audio Out port.

 NOTE

- This function may not be applicable in some models/countries/regions.

- **Headphone Volume**

Independently adjust the volume of audio out devices.

 NOTE

- This function may not be applicable in some models/countries/regions.

Configuring audio type

Press  /  /  button to select  icon, and select **Sound > Audio Type**.

- **Audio Type**

Select the audio type of programmes.

- **Voiceover Output**

Select the voiceover audio out.

 NOTE

- If the model does not have headphone jack, this function will be hidden.
 - This function is not available when Audio Type is Normal.
 - This function is not available when Headphone Mode is Headphone Only and headphone is not connected.
- **Voiceover Volume**
- Independently adjust the volume of voiceover for visually impaired on digital channels. This function is only available when Audio Type is Visually Impaired.

 NOTE

- Audio Type function may not be applicable in some models/countries/regions.

Resetting the sound settings

Press  /  /  button to select  icon, and select **Sound > Reset**.

Reset current sound settings to factory mode.

Accessibility and System

Using Parental Control

Press  /  /  button to select  icon, and select **Parental Control**.

The Parental Control setting allows you to block content that is not appropriate for children to watch.

• Locks

Turning Parental Control On

1. Turn on Locks to enable the Parental Control function.
2. Create PIN window displays. Using the D-pad on your remote, create the password.
3. You will see other Parental Control settings change from a greyed out state to highlighted. When this occurs, begin adding other settings to the **Block Time**, **Channel Block**, **Programme Block**, **Input Block**, **Change PIN** or **Reset** features.

• Block Time

Block certain channels, programmes and inputs during certain periods of time.

• Channel Block

Block selected channels.

• Programme Block

Block programmes by ratings.

• Input Block

Block selected inputs.

• Change PIN

Change the PIN that you use to access Parental Control.

NOTE

- If you forget your password, call the Consumer Electronics Care Centre.
- **Reset**
Reset Parental Control back to the factory setting.

Configuring Device Preferences Settings

Press  /  /  button to select  icon, and select **Device Preferences**.

Date & time

• Automatic date & time

Set to On to use network-provided time.

You can also set the current time manually when Off is selected.

• Set date

Set the date.

• Set time

Set the time.

• Set time zone

Select your time zone.

• Daylight Savings

Select whether to apply Daylight Savings time to the TV.

NOTE

- This function may not be applicable in some models/countries/regions.
- **Use 24-hour format**
Set the time to display in a 12 or 24-hour format.

Language

Adjust the default Language settings for the TV.

Keyboard

Adjust the default settings for the keyboard.

Inputs

View the state of devices that connect to the TV: Connected Input and Standby Inputs, and set Consumer Electronic Control (CEC) function.

For more about Consumer Electronic Control (CEC) settings, Please refer to "Connection > Using HDMI&CEC" section in this manual.

Storage

View the TV storage.

Home screen

- **Customise channels**
Add or delete the app channel row from the Home screen.
- **Enable video previews**
Enable or disable the video previews.
- **Enable audio previews**
Enable or disable the audio previews.
- **Reorder apps/Reorder games**
Rearrange the Apps screen.
- **Android TV Home/Android TV core services**
See the information of open source software licences.

Google Assistant

View permissions about accounts and limit the search results.

Chromecast built-in (Chromecast Android Shell)

Enable your app to stream video and audio to the TV.

Screen saver

Enable Screen saver when the TV is idle.

Location

Use different modes to access location information. Each mode uses different sources to estimate the TV's location.

Usage & Diagnostics

Help improve Android performance by automatically sending diagnostics information.

Accessibility and System

Security & restrictions

Supervise unknown sources for safety and check installed apps for harmful behaviour.

Accessibility

Provide menu options and audio description to aid the visually or hearing impaired.

- **High-contrast text**
Improves contrast for visually impaired.
- **Services**
This menu function contains some service applications, you can choose to open if you need it.

NOTE

- Some functions above may not be applicable in some models/countries/regions.

Reset

Reset to clear your personal setup and information.

About

View the version information, the status of network, and other information. You can also update the software version, change the TV's name or restart your TV.

- **System update**
Provide software updates to continuously enhance your TV and correct any issues that may impact your user experience; therefore, recommend you to keep your TV connected to the Internet to automatically receive updates when they are available.
- **Device name**
Choose a name for your TV. The name will be shown to devices that are available for sharing data.
- **Restart**
Restart your TV.

Configuring Advanced System Settings

Press  /  /  button to select  icon, and select **Advanced System**.

Timer

- **Power On Timer Type**
Set the type Off, Daily, Once.
- **Power On Timer**
Set the clock for the time you want the TV to turn on automatically.
- **Power Off Timer Type**
Set the type Off, Daily, Once.
- **Power Off Timer**
Set the clock for the time you want the TV to turn off automatically.

Power

- **Sleep Timer**
Set the sleep timer to automatically turn the TV off within a specified time: Off, 10 Minutes, 20 Minutes, 30 Minutes, 40 Minutes, 50 Minutes, 60 Minutes, 90 Minutes and 120 Minutes.
 - **Power On Mode**
TV will be powered on based on the mode when TV is reconnected with AC power.
 - **Auto Sleep**
Set the amount of time that you'd like your TV to automatically power off without any activity: Off, 3H, 4H.
-  NOTE
- This function may not be applicable in some models/countries/regions.

Power LED

Set the Power Indicator light to stay On or Off when standby mode.



Store Mode

When selecting Store Mode to On, the TV will be on display in a retail setting, and E-Streamer and other demo functions are effected.

NOTE

- Enabling Store Mode could increase energy consumption.

Support

- **Do Not Track**
Tell websites and some applications your tracking preference.
-  NOTE
- This function may not be applicable in some models/countries/regions.
- **Setup Wizard (Setup assistant)**
Use the Setup assistant for instructions to help you set up your TV.
 - **Send Diagnostics and Usage Information**
Allow to send the diagnostics and usage of the report.
 - **Screenless Mode (only for models with far-fielded Google Assistant)**
Talk to the Google Assistant even when the screen is off. In Screenless Mode, the Google Assistant is always available to help even when the screen is not on. Just say "OK Google". This feature will affect standby power consumption when it is set to On.
-  NOTE
- The far-field Google Assistant and some of its features are only available in selected countries, regions and languages.
- **Remote Control Service**
Remote Control Service features enable your TV to be controlled from the client server to let after-sales diagnose the problem of your TV and dealing with the problem online efficiently. To use this function:
 1. Turn on **Remote Control Service**.
 2. You can initiate a help request to call centres by hotline and provide PIN to the client server centre.

NOTE

- This function may not be applicable in some models/countries/regions.
- Keep the network connected when the Remote Control Service is running.

Mobile Device Connection Tips

Follow the on-screen instructions to learn more about the Screen Sharing and the Content Sharing.

Mobile App Installation

Scan the Mobile App download QR code on screen to install the app on your smartphone to control your TV.

For more about RemoteNOW Download settings, please refer to “Smart Functions > Installing Mobile App to control your TV” section in this manual.

Clear Cache

Clear cache of applications and system.

Help

• **System Message**

View system message, including: Serial Number, Service Code, Software Version, etc.

NOTE

- Serial Number may not be displayed depending on models/countries/regions.

• **Signal Diagnosis**

Perform self diagnosis to test Video Format, Audio Format, Colour Depth, etc.

NOTE

- This function may be called Signal information in some countries/regions.

Troubleshooting

If the TV does not operate as usual or appears to be faulty, please read carefully this section. Many operational issues can be resolved by users.

It is also advisable to unplug the TV from the AC socket on the wall for 60 seconds or more, then reconnect and start again. This simple procedure helps in restoring stable conditions for electric circuits and firmware of the unit.

Picture Problem

When the TV has a picture problem, please review the list of problems and solutions below.

Problem	Possible Solutions
No picture, or black and white picture.	<ul style="list-style-type: none">• Unplug TV from AC outlet and re-plug after 60 seconds.• Check that the Saturation is set to 50 or higher.• Try different TV channels.
The picture is distorted.	<ul style="list-style-type: none">• The compression of video content may cause picture distortions, especially in fast moving pictures from sports programmes and action movies.• If the signal reception is weak or poor, screen distortion may be visible but it is not a malfunction.• Mobile phones used close to the TV (within 1 m) may cause noise on analogue and digital channels.

NOTE

- If the problem persists, check the signal strength or refer to the external device's user manual.

Sound Problem

When the TV has a sound problem, these solutions may help resolve the problem.

Problem	Possible Solutions
There is no sound or the sound is too low at maximum volume.	<ul style="list-style-type: none">• Check the volume control of the device (cable or satellite box, DVD, Blu-ray, etc.) connected to your TV.
Picture is normal, but no sound.	<ul style="list-style-type: none">• Check the volume settings.• Check if 'Mute' mode is set to on.
The speakers are making an odd sound.	<ul style="list-style-type: none">• Make sure that the audio cable is connected to the correct audio output connector on the external device.• For antenna or cable connections, check the signal information.• A low signal level may cause sound distortions.

Picture and Sound Problem

When the TV has a sound and picture problem, these solutions may help resolve the problem.

Problem	Possible Solutions
No sound and picture.	<ul style="list-style-type: none">• Check if the power cord is plugged into a powered AC outlet.• Check to see if the LED light is on or not. If it is, then the TV is receiving power.• Press the  button on the remote control to activate the unit from Standby.
I have connected an external device to my TV but I get no picture and/or sound.	<ul style="list-style-type: none">• Check whether the connection between the external device and your TV is correct.• Make sure you have made the correct selection of input source.
Sound and picture distorted or appear wavy.	<ul style="list-style-type: none">• Some electrical appliances may affect TV set. If you turn off the appliance and the interference goes away, then move it further away from TV.• Insert the power plug of the TV set into another power outlet.
Sound and picture is blurry or cuts out momentarily.	<ul style="list-style-type: none">• If you use an external antenna, check the direction, position and connection of the antenna.• Adjust the direction of your antenna or reset or fine tune the channel.

Internet Problem

When the TV has difficulties in connecting to the Internet, these solutions may help resolve the problem.

Problem	Possible Solutions
The TV cannot connect to your network or apps.	<ul style="list-style-type: none">• Make sure the TV has a network connection.• Contact your Internet service provider.
The wireless network connection failed.	<ul style="list-style-type: none">• Make sure your wireless modem/router is on and is connected to the Internet.
The wireless network signal is too weak.	<ul style="list-style-type: none">• Position your wireless router, modem router, or access point in a central location. Avoid putting it at a corner.

Troubleshooting

Recording/Timeshift Function Isn't Working

When Timeshift or Schedule recording aren't working, these solutions may help resolve the problem.

Problem	Possible Solutions
Schedule Recording cannot be used.	<ul style="list-style-type: none">• Check if there is a USB device connected to the TV.• Recording will automatically stop if the signal becomes too weak.• Check the free space of the USB device. The function will not work if there isn't enough storage space on the USB device.

NOTE

- The Recording/Timeshift functions may not be applicable in certain models/countries/regions.

My File Won't Play

When files aren't playing, this may help resolve the problem.

Problem	Possible Solutions
Some files can't be played.	<ul style="list-style-type: none">• This problem may occur with high-bitrate files. Most files can be played back, but you might experience problems with high-bitrate files.

Other Issues

Use these procedures to resolve other issues that may occur.

Problem	Possible Solutions
The TV is hot.	<p>Watching TV for an extended period of time causes the panel to generate heat. The heat from the panel is dissipated through internal vents running along the top of the TV.</p> <p>After extended use, you may feel hot when touching it. This heat, however, is not a defect and does not affect the TV's functionality.</p>
The TV smells of plastic.	<p>This smell is normal and will dissipate over time.</p>
The plastic cabinet makes a "clicking" type of sound.	<p>The "clicking" sound can be caused when the temperature of the TV changes. This change causes the TV cabinet to expand or contract, which makes the sound. This is normal and the TV is OK.</p>

Other Information

Specifications

Features, appearance and specifications are subject to change without notice.

Item		55"	65"
Dimension (W × H × D)	Without Stand	1235×743×116 mm	1453×866×111 mm
	With Stand	1235×759×236 mm	1453×881×290 mm
Weight	Without Stand	18.4 kg	26.4 kg
	With Stand	20.2 kg	33.0 kg
Active Screen Size (Diagonal)		55 inches (139 cm)	65 inches (164cm)
Screen resolution		3840 × 2160	3840 × 2160
Speaker power		Woofer: 15W+15W Full range: 15W+15W Tweeter: 10W+10W	Woofer: 15W+15W Full range: 15W+15W Tweeter: 10W+10W
Power consumption		180W	248W
Power supply		100-240V~ 50/60Hz	
Receiving systems	Analog	PAL-D/K, B/G, I, SECAM-D/K, B/G	
	Digital	DVB-T/T2, DVB-C	
Environmental conditions		Temperature: 5°C - 45°C Humidity: 20% - 80% RH Atmospheric pressure: 86 kPa - 106 kPa	
HDMI Input		RGB / 60 Hz (640×480, 800×600, 1024×768) YUV / 60 Hz (480 I, 480 P, 720 P, 1080 I, 1080 P) YUV / 50 Hz (576 I, 576 P, 720 P, 1080 I, 1080 P) 2160p 60Hz ,24Hz,25Hz,30Hz,50Hz 2160p 120Hz (only for HDMI 3, 4)	

Other Information

Media Format List

Video:

Number	Video Codec	Resolution	Bit Rate	Profile	Container
1	VP9	3840 × 2160 @ 120fps	60 Mbps	.Profile 0 (420 8bit) Profile 2, (420, 10bit)	MKV (.mkv) WebM (.webm)
2	HEVC/H.265	3840 × 2160 @ 120fps	200Mbps	Main/Main10 Profile, High Tier @Level 6.1	MP4 (.mp4, .mov) / 3GPP (.3gpp, .3gp) MPEG transport stream (.ts, .trp, .tp) / MKV (.mkv) / FLV (.flv) / AVI (.avi) / H265 (.265)
3	MPEG1/2	1920 × 1080 @ 60fps	80Mbps	MP@HL	MPEG program stream (.DAT, .VOB, .MPG, .MPEG) / MPEG transport stream (.ts, .trp, .tp) / MP4 (.mp4, .mov) / 3GPP (.3gpp, .3gp) / AVI (.avi) / MKV (.mkv) / WMV (.wmv) / OGM (.ogm)
4	MPEG4	1920 × 1080 @ 60fps	80Mbps	. Simple Profile . Advanced Simple Profile@ Level 5 . GMC is not supported	MP4 (.mp4, .mov) / 3GPP (.3gpp, .3gp) / AVI (.avi) / MKV (.mkv) / WMV (.wmv) / FLV (.flv) / OGM (.ogm) / MPEG transport stream (.ts, .trp, .tp) / MPEG program stream (.DAT, .VOB, .MPG, .MPEG)
5	Sorenson H.263	1920 × 1080 @ 60fps	80Mbps		FLV (.flv) / AVI (.avi)
6	H.263	1920 × 1080 @ 60fps	80Mbps		FLV (.flv) / MP4 (.mp4, .mov) / 3GPP (.3gpp, .3gp) / AVI (.avi) / WMV (.wmv)
7	H.264	3840 × 2160@120fps	200Mbps	Main, High and High10 profile up to level 6.0	FLV (.flv) / MP4 (.mp4, .mov) / 3GPP (.3gpp, .3gp) / MPEG transport stream (.ts, .trp, .tp) / WMV (.wmv) / AVI (.avi) / MKV (.mkv) / OGM (.ogm) / MPEG program stream (.DAT, .VOB, .MPG, .MPEG) / H264 (.264)
8	AVS	1920 × 1080@60fps	80Mbps 60Mbps	Jizhun profile @ Level 6.0 Guangbo profile @ Level 6.0	3GPP (.3gpp, .3gp) / MP4 (.mp4, .mov) / MPEG transport stream (.ts, .trp, .tp) / AVS (.avs)
9	AVS2	3840 × 2160@60fps	100Mbps	Main/Main-10bit Profile @ Level 8.2.60	MPEG transport stream (.ts, .trp, .tp) / AVS2 (.avs2)
10	WMV3	1920 × 1080 @ 60fps	80Mbps		AVI (.avi) / MKV (.mkv) / WMV (.wmv) / 3GPP (.3gpp, .3gp) / MP4 (.mp4, .mov) / OGM (.ogm)
11	VC1	1920 × 1080 @ 60fps	80Mbps	. Advanced Profile@Level 3 . Simple Profile . Main Profile	MPEG transport stream (.ts, .trp, .tp) / WMV (.wmv) / AVI (.avi) / MKV (.mkv) / 3GPP (.3gpp, .3gp) / MP4 (.mp4, .mov) / VC1 (.vc1)
12	Motion JPEG	1920 × 1080 @ 30fps	30Mbps		AVI (.avi) / 3GPP (.3gpp, .3gp) / MP4 (.mp4, .mov) / MKV (.mkv) / FLV (.flv) / OGM (.ogm)
13	VP8	1920 × 1080 @ 60fps	60Mbps		MKV (.mkv) / WebM (.webm) / FLV (.flv) / 3GPP (.3gpp, .3gp) / MP4 (.mp4, .mov) / AVI (.avi) / OGM (.ogm)
14	AV1	3840 × 2160@120fps	60Mbps	Main Profile @Level 6.0	MP4 (.mp4, .mov) / 3GPP (.3gpp, .3gp) / MKV (.mkv) / WebM (.webm)

Audio:

Number	Audio Codec	Sample rate	Channel	Bit Rate	Container	Note
1	MPEG1/2 Layer1	16KHz ~ 48KHz	Up to 2	32Kbps ~ 448Kbps	MP3 (.mp3) / AVI (.avi) / WMV (.wmv) / MKV (.mkv, .mka) / 3GPP (.3gpp, .3gp) / MP4 (.mp4, .mov, m4a) / MPEG transport stream (.ts, .trp, .tp) / MPEG program stream (.DAT, .VOB, .MPG, .MPEG) / FLV (.flv) / WAV (.wav) / OGM (.ogm)	
2	MPEG1/2 Layer12	16KHz ~ 48KHz	Up to 2	8Kbps ~ 384Kbps	MP3 (.mp3) / AVI (.avi) / WMV (.wmv) / MKV (.mkv, .mka) / 3GPP (.3gpp, .3gp) / MP4 (.mp4, .mov, m4a) / MPEG transport stream (.ts, .trp, .tp) / MPEG program stream (.DAT, .VOB, .MPG, .MPEG) / FLV (.flv) / WAV (.wav) / OGM (.ogm)	
3	MPEG1/2/2.5 Layer3	8KHz ~ 48KHz	Up to 2	8Kbps ~ 320Kbps	MP3 (.mp3) / AVI (.avi) / WMV (.wmv) / MKV (.mkv, .mka) / 3GPP (.3gpp, .3gp) / MP4 (.mp4, .mov, m4a) / MPEG transport stream (.ts, .trp, .tp) / MPEG program stream (.DAT, .VOB, .MPG, .MPEG) / FLV (.flv) / WAV (.wav) / OGM (.ogm)	

Other Information

4	AC3(DD)	32KHz, 44.1KHz, 48KHz	Up to 5.1	32Kbps ~ 640Kbps	AC3 (.ac3) / AVI (.avi) / MKV (.mkv, .mka) / 3GPP (.3gpp, .3gp) / MP4 (.mp4, .mov, m4a) / MPEG transport stream (.ts, .trp, .tp) / MPEG program stream (.DAT, .VOB, .MPG, .MPEG) / WMV (.wmv) / OGM (.ogm)	
5	EAC3(DDP)	32KHz, 44.1KHz, 48KHz	Mono, Stereo, 7.1CH up to 15 object and Lfe decoder can render to 5.1.2	Up to 6.144Mbps	EAC3 (.ec3) / AVI (.avi) / MKV (.mkv, .mka) / 3GPP (.3gpp, .3gp) / MP4 (.mp4, .mov, m4a) / MPEG transport stream (.ts, .trp, .tp) / MPEG program stream (.DAT, .VOB, .MPG, .MPEG) / WMV (.wmv) / OGM (.ogm)	
6	AAC-LC, HEAAC	8KHz ~ 48KHz	Up to 5.1	16kbps~ 576kbps	AAC (.aac) / AVI (.avi) / MKV (.mkv, .mka) / 3GPP (.3gpp, .3gp) / MP4 (.mp4, .mov, m4a) / MPEG transport stream (.ts, .trp, .tp) / MPEG program stream (.DAT, .VOB, .MPG, .MPEG) / FLV (.flv) / WAV (.wav) / WMV (.wmv) / OGM (.ogm)	
7	WMA7, WMA8, WMA9	8KHz ~ 48KHz	Up to 2	32bps ~ 192Kbps	WMV (.wma, .wmv) / AVI (.avi) / MKV (.mkv, .mka) / 3GPP (.3gpp, .3gp) / MP4 (.mp4, .mov)	WMA 7, WMA 8, WMA 9 Standard
8	WMA9 Pro	16KHz ~ 48KHz	Up to 5.1	48kbps ~ 384kbps	WMV (.wma, .wmv) / AVI (.avi) / 3GPP (.3gpp, .3gp) / MP4 (.mp4, .mov)	
9	VORBIS	6KHz ~ 48KHz	Up to 5.1	8kbps ~ 500kbps	MKV (.mkv, .mka) / WebM (.webm) / 3GPP (.3gpp, .3gp) / MP4 (.mp4, .mov, m4a) / Ogg (.ogg) / WMV (.wmv) / AVI (.avi)	Supports stereo decoding only
10	DTS, DTS HD	32KHz, 44.1KHz, 48KHz	Up to 5.1	32kbps ~ 1.5Mbps	MPEG transport stream (.ts, .trp, .tp) / MPEG program stream (.DAT, .VOB, .MPG, .MPEG) / WAV (.wav) / MKV (.mkv, .mka) / 3GPP (.3gpp, .3gp) / MP4 (.mp4, .mov, m4a) / AVI (.avi) / OGM (.ogm) / DTS (.dts)	
11	DTS LBR(express)	32KHz, 44.1KHz, 48KHz	Up to 5.1	32kbps ~ 1.5Mbps	MP4 (.mp4, .mov) / 3GPP (.3gpp, .3gp) / MPEG transport stream (.ts, .trp, .tp)	
12	LPCM	6KHz ~ 192KHz	Mono, Stereo		WAV (.wav) / AVI (.avi) / MKV (.mkv, .mka) / 3GPP (.3gpp, .3gp) / MP4 (.mp4, .mov, m4a) / MPEG transport stream (.ts, .trp, .tp) / MPEG program stream (.DAT, .VOB, .MPG, .MPEG) / WMV (.wmv) / FLV (.flv) / OGM (.ogm)	
13	FLAC	8KHz ~ 192KHz	Up to 5.1	128kbps ~ 2304kbps	MKV (.mkv, .mka) / FLAC (.flac)	
14	OPUS	8KHz ~ 48KHz	Up to 5.1	6Kbps ~ 510Kbps	MKV (.mkv, .mka) / WebM (.webm)	
15	AC4	44.1KHz, 48KHz	Max. 11 channels Max. 10 objects	Up to 6140kbps	MPEG transport stream (.ts, .trp, .tp) / 3GPP (.3gpp, .3gp) / MP4 (.mp4, .mov, m4a) / AC4 (.ac4)	
16	MPEG-H	16KHz, 24KHz, 32KHz, 48KHz	Up to 2	20kbps ~ 1200kbps	3GPP (.3gpp, .3gp) / MP4 (.mp4, .mov, m4a)	
17	DRA	32KHz, 44.1KHz, 48KHz	Up to 5.1	32kbps ~ 9612kbps	MPEG transport stream (.ts, .trp, .tp)	
18	APE	32KHz, 44.1KHz, 48KHz	Up to 2	500kbps ~ 1.5Mbps	APE(.ape)	
19	AMR-NB	8KHz	1	4.75 ~ 12.2Kbps	3GPP (.3gpp, .3gp) MP4 (.mp4, .mov, m4a)	
20	AMR-WB	16KHz	1	6.6 ~ 23.85Kbps	3GPP (.3gpp, .3gp) MP4 (.mp4, .mov, m4a)	

Other Information

Photo:

Number	Image	Photo	Resolution (width x height) (MTK suggests)	Remark
1	JPEG	Base-line	15360 x 8640	The limitation of max resolution depending on DRAM size
		Progressive	1024 x 768	The limitation of max resolution depending on DRAM size
2	PNG		9600 x 6400	The limitation of max resolution depending on DRAM size
3	BMP		9600 x 6400	The limitation of max resolution depending on DRAM size
4	GIF		6400 x 4800	The limitation of max resolution depending on DRAM size
5	WebP		3840 x 2160	The limitation of max resolution depending on DRAM size
6	HEIF		4000 x 3000	The limitation of max resolution depending on DRAM size

License Information

License Information

- The terms HDMI and HDMI High-Definition Multimedia Interface, and the HDMI logo are trademarks or registered trademarks of HDMI Licensing Administrator, Inc. in the United States and other countries.



- DVB is a registered trademark of the DVB Project.
- [1] EIA/CEA-861-D compliance covers the transmission of uncompressed digital video with high-bandwidth digital content protection, which is being standardized for reception of high-definition video signals. Because this is an evolving technology, it is possible that some devices may not operate properly with the television.

MP3 licence letter

MPEG Layer-3 audio coding technology licensed from Fraunhofer IIS and Thomson.

MP4 licence letter

THIS PRODUCT IS LICENSED UNDER THE MPEG-4 VISUAL PATENT PORTFOLIO LICENSE FOR THE PERSONAL AND NON-COMMERCIAL USE OF A CONSUMER FOR (I) ENCODING VIDEO IN COMPLIANCE WITH THE MPEG-4 VISUAL STANDARD (MPEG-4 VIDEO) AND/OR (II) DECODING MPEG-4 VIDEO THAT WAS ENCODED BY A CONSUMER ENGAGED IN A PERSONAL AND NON-COMMERCIAL ACTIVITY AND/OR WAS OBTAINED FROM A VIDEO PROVIDER LICENSED BY MPEG LA TO PROVIDE MPEG-4 VIDEO. NO LICENSE IS GRANTED OR SHALL BE IMPLIED FOR ANY OTHER USE. ADDITIONAL INFORMATION INCLUDING THAT RELATING TO PROMOTIONAL, INTERNAL AND COMMERCIAL USES AND LICENSING MAY BE OBTAINED FROM MPEG LA, L.L.C. SEE [HTTP://WWW.MPEGLA.COM](http://www.mpegla.com)

AVC licence letter

THIS PRODUCT IS LICENSED UNDER THE AVC PATENT PORTFOLIO LICENSE FOR THE PERSONAL AND NONCOMMERCIAL USE OF A CONSUMER TO (I) ENCODE VIDEO IN COMPLIANCE WITH THE AVC STANDARD ("AVC VIDEO") AND/OR (II) DECODE AVC VIDEO THAT WAS ENCODED BY A CONSUMER ENGAGED IN A PERSONAL AND NON-COMMERCIAL ACTIVITY AND/OR WAS OBTAINED FROM A VIDEO PROVIDER LICENSED TO PROVIDE AVC VIDEO. NO LICENSE IS GRANTED OR SHALL BE IMPLIED FOR ANY OTHER USE. ADDITIONAL INFORMATION MAY BE OBTAINED FROM MPEG LA, L.L.C. SEE [HTTP://WWW.MPEGLA.COM](http://www.mpegla.com)

Licence Notification

TRADEMARK ACKNOWLEDGMENT



For DTS patents, see <http://patents.dts.com>. Manufactured under license from DTS Licensing Limited. DTS, DTS-HD Master Audio, DTS-HD, Virtual:X, and the DTS-HD logo are registered trademarks or trademarks of DTS, Inc. in the United States and other countries. © 2020 DTS, Inc. ALL RIGHTS RESERVED.



Manufactured under license from IMAX Corporation. IMAX® is a registered trademark of IMAX Corporation in the United States and/or other countries. For DTS patents, see <http://patents.dts.com>. Manufactured under license from DTS Licensing Limited. DTS and the DTS logo are registered trademarks or trademarks of DTS, Inc. in the United States and other countries. © 2020 DTS, Inc. ALL RIGHTS RESERVED.



Dolby, Dolby Vision, Dolby Atmos, and the double-D symbol are registered trademarks of Dolby Laboratories Licensing Corporation. Dolby Vision IQ is a trademark of Dolby Laboratories Licensing Corporation. Manufactured under license from Dolby Laboratories. Confidential unpublished works. Copyright © 2012-2020 Dolby Laboratories. All rights reserved.

License Information

Disposal of Used Electrical & Electronic Equipment

Packaging and electrical goods should be recycled appropriately, and not treated as household waste. Please dispose of this equipment at your applicable collection point for the recycling of electrical & electronic equipment waste. By ensuring the correct disposal of this product, you will help prevent potentially hazardous to the environment and to human health, which could otherwise be caused by unsuitable waste handling of this product. The recycling of materials will help conserve natural resources. Please do not therefore dispose of your old electrical and electronic equipment with your household waste. For more detailed information about recycling of this product, please contact your local city office, your household waste disposal service or the shop where you purchased the product.

