

TECHNIKA

PROFESSIONAL SERIES

USER GUIDE
MULTIFUNCTION 60CM OVEN
TGO614ABK

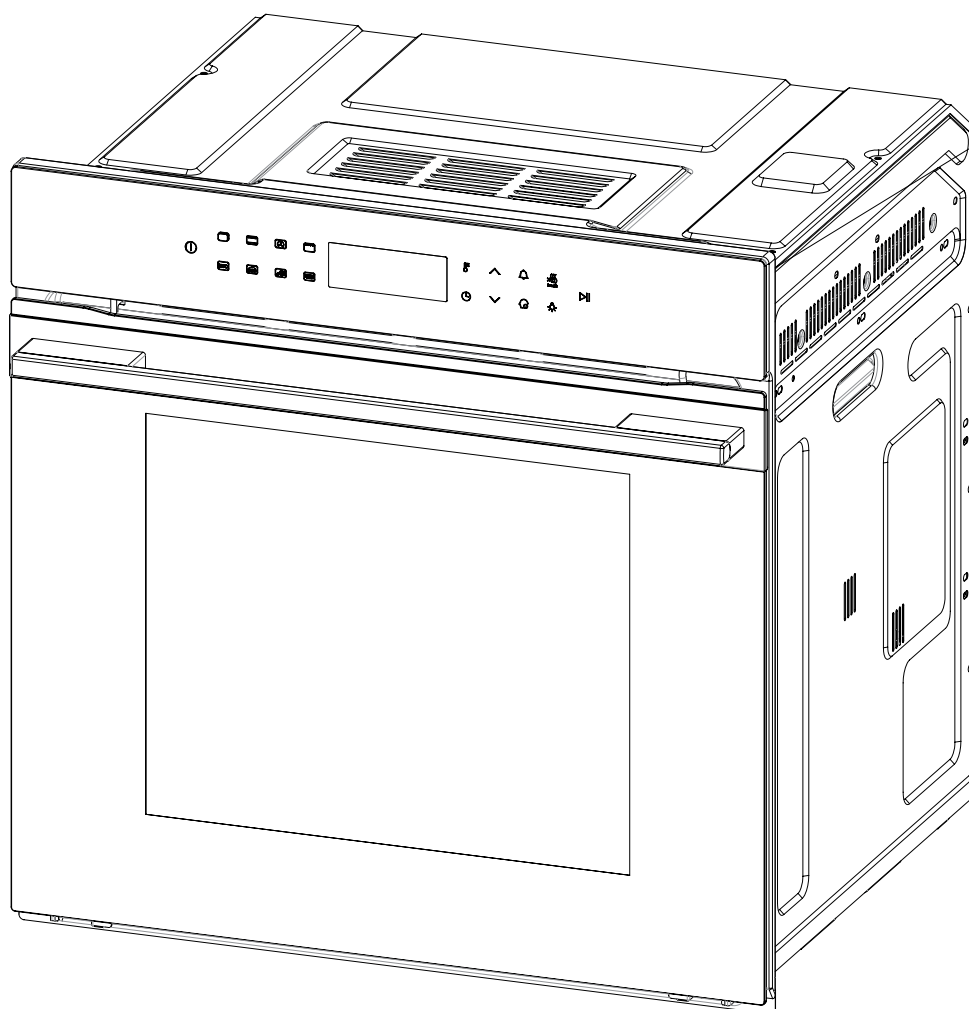

CONTENTS TABLE

For Your Safety	4
Use and Care	
Controls	7
Oven & accessories	8
How to use your oven	9
Positioning the oven trays & shelves	10
Cooking modes	15
The oven light	20
Cooling ventilation	20
Practical cooking advice	21
Cooking guide	25
Cleaning and maintenance	28
How to remove the oven door	29
Troubleshooting	31
Replacing the oven lamp	32
Disposal	32
Installation	
Cabinet details	33
Electrical connection	34
Technical data	35
Warranty	36

We recommend that you read the instructions in this owner's manual carefully before use for the best performance and to extend the life of your appliance. It will provide you with all the information you need to ensure its safe installation, use and maintenance. Retain this owner's manual for future reference.

When handling the appliance, we recommend you always use the handles recessed into the sides of the oven to prevent personal injury or damage to the appliance.

To maintain the efficiency and safety of this appliance, we recommend that you do the following:

- Always call the Glen Dimplex service department if there are any faults with your appliance.
- Always use original spare parts available from Glen Dimplex.
- This appliance is designed for non-commercial, household use and it must not be altered in any way.
- **WARNING:** This appliance is a domestic kitchen appliance suitable for indoor installation. It is not suitable for outdoor installations such as alfresco kitchens or garages unless a qualified, competent installer has deemed the location and installation to be suitable & compliant.
- This appliance can only be used safely when it is correctly connected to an efficient earthing system in compliance with current electrical safety standards.
- If the supply cord is damaged, it must be replaced by the manufacturer or its service agent or a similarly qualified person in order to avoid a hazard.
- During use, the appliance becomes hot. Care should be taken to avoid touching heating elements inside the oven.
- **WARNING:** Accessible parts will become hot when in use.
- To avoid burns and scalds, children should be kept away.
- This appliance is not intended for use by persons (including children) with reduced physical, sensory or mental capabilities, or lack of experience and knowledge, unless they have been given supervision or instruction concerning use of the appliance by a person responsible for their safety.
- Young children should be supervised to ensure that they do not play with the appliance.
- DO NOT use a steam cleaner to clean the appliance.

Packaging items such as plastic bags, polystyrene, nails, etc. are potentially dangerous, and therefore appropriate measures must be taken to prevent children and the disabled from coming into contact with them.

Avoid the following:

- Touching the appliance with wet parts of the body.
- Using the appliance while barefoot.
- Improper or dangerous operation.
- Obstructing the ventilation or heat dissipation slots.
- Allowing power supply cables of other appliances to come into contact with hot parts of the oven.
- Exposing the appliance to atmospheric agents such as rain, or direct sunlight.
- Using the oven for storage purposes.
- Using flammable liquids near the appliance.

Authorised personnel must be contracted to...

- Install the appliance according to these installation instructions and any local requirements.
- Replace the temperature probe if it is damaged. The probe is part of thermostat. Only use the temperature sensing probe recommended for this oven.

Glen Dimplex Service Department must be contacted...

- If in doubt about the operation of the appliance.
- If in doubt about the soundness of the appliance after removing it from its packaging.
- If the power supply cable has been damaged or needs to be replaced.
- If the appliance requires a service.
- If you need spare parts.

WARNINGS:

- DO NOT steam clean the oven.
- DO NOT use harsh abrasive cleaners or sharp metal scrapers to clean the oven door glass since they can scratch the surface, which may result in shattering of the glass.
- DO NOT install the appliance behind a decorative door in order to avoid overheating.
- Only use the appliance to cook food and nothing else.
- Check that the appliance has not been damaged immediately after it has been unpacked.
- Disconnect the appliance from the electrical mains if it is not functioning properly and before cleaning or performing maintenance.
- When left unused for a long period, unplug the appliance from the electricity mains.
- Use oven gloves to place cookware in the oven or when removing it.
- Always grip the oven door handle in the centre.
- Make sure the appliance is switched off when not in use.
- Glen Dimplex will not accept any liability as a result of any damage due to incorrect installation or improper use.



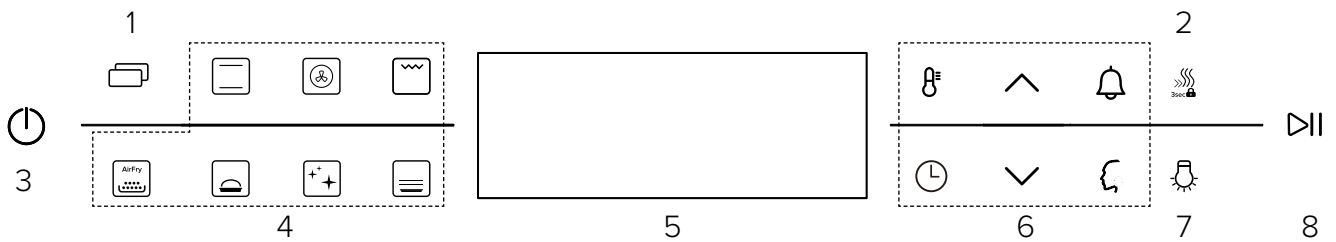

















Controls



- 1. Function Button
- 2. Rapid Heating Button
- 3. On/Off Button
- 4. Shortcut Function Button
- 5. Window Display
- 6. Auxiliary Function
- 7. Light Button
- 8. Start/Stop Button

 7 functions include:



	Conventional		Fan Assist		Plate Warming
	Fan Forced		Half Grill		Kitchen Timer
	Full Grill		Multi Cooking		Temperature
	Fan grill		Defrost		Memory
	Pizza		Energy Saving		Temperature Function
	Airfry		Dough Proving		Timer
	Steam Clean		Pastry Bake		

Oven & Accessories

The oven is supplied with the following accessories:

1. **Oven rack x 2**



2. **Grill tray / Baking tray**



3. **Grill insert**



4. **Telescopic rails (1 set)**

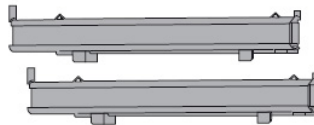

5. **Air Fry basket**

For Air Fry mode the basket can be inserted into the shelf guides in the same way as the oven racks or baking trays.

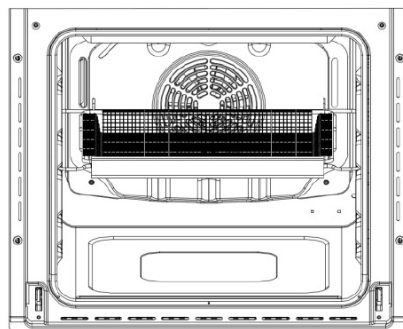
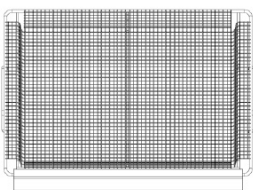

How to use your oven

There are five shelf positions in the oven.
Shelf levels are numbered from the bottom up.
Levels 4 and 5 are used mainly for the grill function.

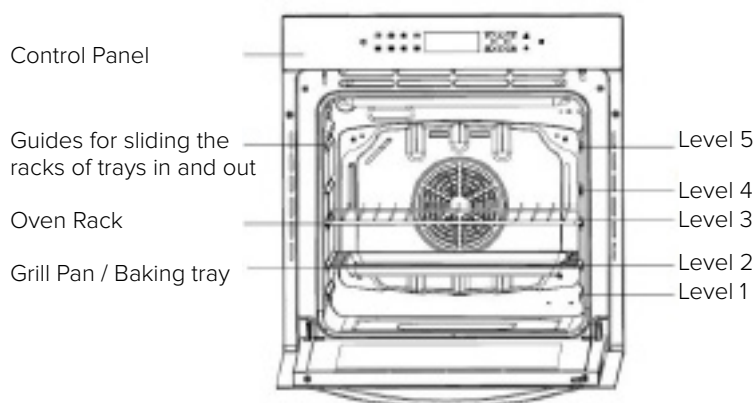

Note: Place tray on the bottom shelf position of the oven to prevent any spillages from dripping onto the bottom of the oven. **Never place anything (including foil and oven trays) on the bottom of the oven when it is in operation because this could damage the enamel.** Only place your cookware (dishes, trays, aluminum foil, etc.) on the oven shelves provided with the appliance.



If supplied, use the chrome wire handle shown left when removing the trays from the oven.

Positioning the oven trays & shelves

The Grill Tray or Oven Shelf can be located in any of the five height positions in the oven. Refer to the 'Cooking Guide Table' for the recommended shelf position. When fitting the trays or shelves, ensure they are fitted between the two wires that are closest together as shown below.

Oven Shelves have a stop so that they are not fully withdrawn by accident. To fully remove the Oven Shelves, lift the front of the shelf slightly and withdraw fully from the oven. Note that the Grill Tray does not have a stop position and can be fully withdrawn without interruption, so be careful not to accidentally fully withdraw the tray.

Fit Trays and Shelves between bars as shown right.

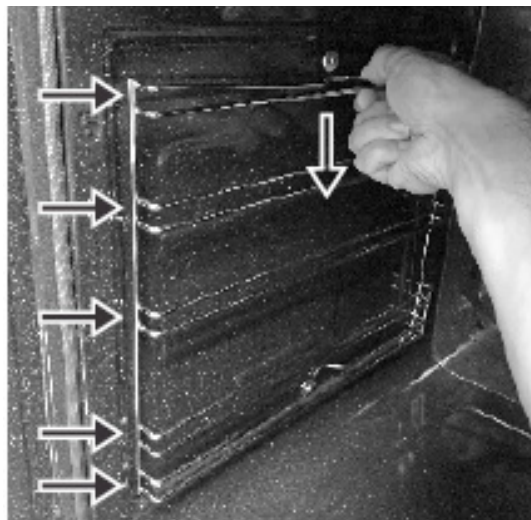

To remove the Oven Shelf Support, push down on the wire below the top locking pin, pull away from the oven wall until you can release the top of the support from the holes in the oven wall. Replace in reverse procedure.

Chrome Wire Shelf Support



Shown With Oven Shelf

Telescopic rails

The oven may also include a set of telescopic rails which can be positioned on different levels and allow the oven racks or trays to slide in and out effortlessly.

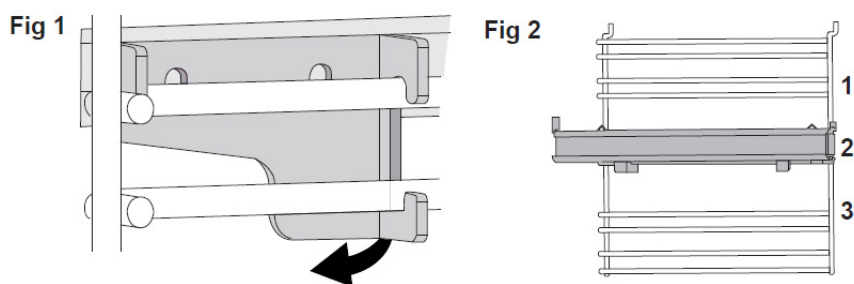

- To un-clip the telescopic rail for cleaning or repositioning purposes you must apply outward pressure on the underside of the telescopic rail to release, as shown in Fig 1 (Note: reverse of rail shown).
- To re-fit the telescopic rail, locate the clip into the top rail on the shelf guide and push downward, the rail will clip into place.
- The telescopic rail is designed to support either a shelf or grill / baking tray and can be installed on any of the shelf positions as shown in Fig 2.

This multi-function oven combines the advantages of traditional conventional ovens with those of the more modern fan assisted models in a single appliance.



It is an extremely versatile appliance that allows you to choose easily and safely between different cooking modes.

Before You Begin:

Setting the clock

When power is first supplied to the oven, the display on the control panel will light briefly and '12:00' will appear in the display.

The clock can only be set with the oven in standby mode.

1. "12:00" will appear in the display when power is first supplied to the appliance.
2. Touch the **Time Button**,  "12:00" will blink in the display.
3. Touch the **Temp/ Function Adjust Button** to set the time.
4. Touch **Time Button**  again to save the settings.

Initial cleaning

Clean the oven thoroughly before using for the first time. Do not use sharp or abrasive cleaning materials. These could damage the oven.

To clean the oven

1. Open the door, the oven lights comes on by touching the Light Button.
2. Clean all oven trays, accessories and side runners with warm water or washing up liquid and polish dry with a soft clean cloth.
3. Clean the oven interior with a soft clean cloth.
4. Wipe the front of the appliance with a damp cloth.

Check that the clock is set correctly. Remove accessories and operate the oven on the fan forced setting at 200 °C for 1 hour before using. There will be a distinctive odor; this is normal, but ensure your kitchen is well ventilated during this conditioning period.

Safety shutoff

This oven's electrical circuitry features a thermal shutoff system. If the oven heats to abnormally high temperatures, the system will shut off the power supply to the heating elements for a period of time until the oven cools down to a safe temperature. Attention: The oven comes with a soft close door feature which will only operate correctly when sufficient initial force is applied when closing. Should insufficient force be applied, the door may need to be closed manually.



Switching the Oven On/Off

To switch the oven on/off, touch the **On/Off Button**.  When the oven is switched on, it will enter standby mode until a function has been selected.

Switching the Light On/Off

To switch the light on/off, touch the Light Button . The light will also switch on when any oven function is running.

Setting the oven function

1. After the clock is set, touch the button of the desired cooking function on the control panel or, Touch the **Function Button**  and then use the **Temp /Function Adjust Button**  or  to select the desired function

Note: Each function has a preset temperature and cooking time which will be displayed on the control panel once a function has been selected. (See section on 'Oven Functions')

2. If you are happy with the preset temperature and cooking time, touch the **Start/Stop Button**  to begin cooking.







To change the temperature or cooking time, please see the following instructions.

Setting the oven temperature

1. After the function is selected, touch the **Temperature button**  to enter the temperature settings.
2. Touch or touch and hold the **Temp /Function Adjust Button**  or  to adjust the temperature up or down.





Setting the Cook time

You can also set the cook time during cooking.

1. Touch the **Time Button**  The Cook time icon  on the display begins to flash.
2. Touch the **Temp /Function Adjust Button**  or  to set the desired cook time.
3. Touch the **Time Button**  again and the End time icon on the display begins to flash. Touch the **Time Button**  again to skip the End time or follow steps 2 and 3 below to set the End time.









Setting the End time

You can also set the end time during cooking.





1. Touch the **Time Button**  several times until the End time icon  on the display begins to flash.
 2. Touch the **Temp /Function Adjust Button**  or  to set the desired end time.
 3. Touch the **Time Button**  again or wait for about 3 seconds and the new end time will be set.
- When the cooking time has ended "E10" will show in the display and the oven will beep 5 times.

Delayed start / Automatic cooking

If the end time is entered after the cook time has already been set, the cook time and the end time are calculated and if necessary the oven sets a delayed start point. This can be used for automatic cooking where the oven will start and end at the chosen time.

1. Turn the oven on and select a function as above.
2. Touch the **Time Button**  The Cook time icon  on the display begins to flash.
Example : Current time is 3:00 and the desired cook time is 1 hour.
3. Touch the **Temp /Function Adjust Button**  or  to set the desired cook time (1:00)
4. Touch the **Time Button**  again. The end time icon  on the display begins to flash.
Example: You want to cook for 1 hour and finish at 8:30.
5. Touch the **Temp /Function Adjust Button**  or  to set the desired end time (8:30)
6. Touch the **Time Button**  again. The oven will be inoperative until the delayed start point.
In this example, the oven will turn on at 7:30, cook for 1 hour and turn off at 8:30.

Kitchen timer

1. Touch the **Kitchen Timer Button**  and the Bell icon  on the display begins to flash.
2. Touch the **Temp /Function Adjust Button**  or  to set the desired time.
3. Touch the **Kitchen Timer Button**  to start the kitchen timer. When the set time has elapsed, an audible signal sounds

Child safety function





1. Touch and hold the **Rapid Heating Button**  for 3 seconds. The lock icon will appear in the display .
2. Touch and hold the **Rapid Heating Button**  for 3 seconds again to unlock.

Rapid Heating (preheating)

With the use of the Rapid Heating function, the empty oven can be preheated in a short time. Important: before the completion of the Rapid Heating function, do not put food into the oven for baking.

1. Set the desired oven function and temperature for cooking.
2. Touch the **Rapid Heating Button** . An audible signal sounds. When the temperature is reached, an audible signal sounds for about 2 seconds. The oven then returns to the set cooking function and temperature. The food can now be placed into the oven.

Memory function

1. When the function has ended and “E110” is displayed, the current cooking mode can be stored by touching and holding the **Memory Button**  without touching any other button. A total of 4 cooking modes can be stored. When more than 4 modes are stored, the earliest cooking mode will be replaced.
2. In stand-by mode (oven turned on but no function selected), touch the **Memory Button** , the screen will display the cooking modes that have been stored,
3. Touch the **Temp /Function Adjust Button**  or  to select the desired cooking mode and press the **Start/Stop Button**  to begin cooking in the chosen mode.

Control Modes



Conventional Mode

The top and bottom heating elements come on. This is the classic, traditional type of oven which has been perfected, with exceptional heat distribution and reduced energy consumption. The conventional oven is still unequalled when it comes to cooking dishes made up of several ingredients, e. g. cabbage with ribs, Spanish style cod, Ancona style stockfish, tender veal strips with rice, etc. Excellent results are achieved when preparing veal or beef-based dishes as well (braised meats, stew, goulash, wild game, ham etc.) which need to cook slowly and require basting or the addition of liquid. It nonetheless remains the best system for baking cakes as well as fruit and cooking using covered casserole dishes for oven baking. When cooking in conventional mode, only use one dripping pan or cooking rack at a time, otherwise the heat distribution will be uneven. Using the different rack heights available, you can balance the amount of heat between the top and the bottom of the oven. Select from among the various rack heights based on whether the dish needs more or less heat from the top.

Pre Set Temperature °C	Pre-set Cooking time (hh:mm)	Temperature Range °C	Maximum Cooking Time (hh:mm)
170	1:00	30-260	23:59



Fan Assist Mode

The top and bottom heating elements, as well as the fan, will come on, guaranteeing constant heat distributed uniformly throughout the oven. This mode is especially recommended for cooking prepacked food quickly (as pre-heating is not necessary), such as for example: frozen or pre-cooked food) as well as for a few “home-made” dishes. The best results when cooking using the “Fan Assist” mode are obtained if you use one cooking only (the second from the bottom), please see the table entitled “Practical Cooking Advice”.

Pre Set Temperature °C	Pre-set Cooking time (hh:mm)	Temperature Range °C	Maximum Cooking Time (hh:mm)
200	1:00	30-260	23:59



Multi Cooking Mode

The top, rear and bottom heating elements, as well as the fan, will come on alternately. Since the heat remains constant and uniform throughout the oven, the air cooks and browns food uniformly over its entire surface. With this mode, you can also cook various dishes at the same time, as long as their respective cooking temperatures are the same. A maximum of 2 racks can be used at the same time, following the instructions in the section entitled: "Cooking On More Than One Rack".

This cooking mode is particularly recommended for dishes requiring a gratin finish or for those requiring considerably prolonged cooking times, such as for example: lasagne, pasta backs, roast chicken and potatoes, etc.. Moreover the excellent heat distribution makes it possible to use lower temperatures when cooking roasts. This results in less loss of juices, meat which is more tender and a decrease in the loss of weight for the roast. The Multi-cooking mode is especially suited for cooking fish, which can be prepared with the addition of a limited amount of condiments, thus maintaining their flavor and appearance. Excellent results can be attained when cooking vegetable-based side dishes like courgettes, aubergines, peppers, etc...

Desserts: this mode is also perfect for baking leavened cakes. Moreover, this mode can also be used to thaw quickly white or red meat and bread by setting the temperature to 80°C. To thaw more delicate foods, set the thermostat to 60°C or use only the cold air circulation feature by setting the thermostat to 0°C.

Pre Set Temperature °C	Pre-set Cooking time (hh:mm)	Temperature Range °C	Maximum Cooking Time (hh:mm)
170	1:00	30-260	23:59



Pizza Mode

The bottom and rear heating elements, as well as the fan, will come on. This combination rapidly heats the oven due to the large amounts of power used by the appliance, which results in the production of considerable heat coming prevalently from the bottom.

The pizza mode is ideal for foods requiring high temperatures to cook, like pizzas and large roasts. Only use one oven tray or rack at a time. However, if more than one is used, these must be switched halfway through the cooking process.

Pre Set Temperature °C	Pre-set Cooking time (hh:mm)	Temperature Range °C	Maximum Cooking Time (hh:mm)
170	1:00	30-260	23:59

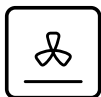

Pastry Bake

The bottom heating element and the fan come on. Suitable for pastries, cakes and non-dry sweets in baking tins or moulds. Excellent results are also obtained in cooking requiring above all heat from the bottom. You are advised to put the pan on a low level.

Pre Set Temperature °C	Pre-set Cooking time (hh:mm)	Temperature Range °C	Maximum Cooking Time (hh:mm)
150	1:00	50-230	23:59



Air fry Mode

The top and rear heating elements, as well as the fan, will come on. Air fry enables advanced convection cooking function without having to turn the food, giving crispy great tasting results in a shorter time without all the oil. This is suitable for french fries, chicken wings, nuggets and similar products.

Pre Set Temperature °C	Pre-set Cooking time (hh:mm)	Temperature Range °C	Maximum Cooking Time (hh:mm)
230	0:22	150-230	23:59



Half Grill Mode

The top central heating element comes on. "Grill" directs radiant heat from the powerful upper element onto the food. You can use the "Grill" function for tender cuts of meat, steak, chops, sausages, fish, cheese toasties and other quick cooking foods. Grill with the oven door closed. Preheat your grill for 3 minutes to get the best results. This will help seal in the natural juices of steak, chops etc. for a better flavour. You can slide your grill dish into either of the 2 spaces within the upper pairs of support rails. Grill food with the oven door closed.

Pre Set Temperature °C	Pre-set Cooking time (hh:mm)	Temperature Range °C	Maximum Cooking Time (hh:mm)
180	0:30	80-230	23:59



Full Grill Mode

The top inside and outside heating elements come on. "Maxi grill" directs radiant heat from 2 powerful upper elements onto the food. You can use the "Maxi grill" function for tender cuts of meat, steak, chops, sausages, fish, cheese toasties and other quick cooking foods. Grill with the oven door closed. "Maxi grill" allows you to take full advantage of the large grill dish area and will cook faster than normal "Grill". For best results it is recommended to preheat your grill for 3 minutes. This will help seal in the natural juices of steak, chops etc. for a better flavour. Grill food with the oven door closed.

Pre Set Temperature °C	Pre-set Cooking time (hh:mm)	Temperature Range °C	Maximum Cooking Time (hh:mm)
200	0:30	80-230	23:59



Fan Assisted Grill

The top heating elements and the fan come on. This combination of features increases the effectiveness of the unidirectional thermal radiation of the heating elements through forced circulation of the air throughout the oven. This helps prevent food from burning on the surface, allowing the heat to penetrate right into the food. Excellent results are achieved with kebabs made with meats and vegetables, sausages, ribs lamb chops, chicken in a spicy sauce, quail, pork chops, etc. This mode is also ideal for cooking fish steaks, like swordfish, stuffed cuttlefish etc. Grill food with the oven door closed.

Pre Set Temperature °C	Pre-set Cooking time (hh:mm)	Temperature Range °C	Maximum Cooking Time (hh:mm)
180	1:00	80-230	23:59



Fan Forced

The rear heating element and the fan come on, guaranteeing delicate heat distributed uniformly throughout the oven. This mode is ideal for baking and cooking delicate foods—especially cakes that need to rise—and for the preparation of certain tartlets on 3 shelves at the same time. Here are a few examples: cream puffs, sweet and savory biscuits, savoury puffs, Swiss rolls and small portions of vegetables au gratin, etc.

When cooking with Baking Mode, the temperature should generally be set 20C lower than when cooking with normal conventional mode.

Pre Set Temperature °C	Pre-set Cooking time (hh:mm)	Temperature Range °C	Maximum Cooking Time (hh:mm)
160	1:00	30-260	23:59



“Defrosting” Mode

The fan located in the back of the oven makes the air circulate at room temperature around the food. This is recommended for the defrosting of all types of food, but in particular for delicate types of food which do not require heat, such as for example: ice cream cakes, cream or custard desserts, fruit cakes. By using the fan, the defrosting time is approximately halved. In the case of meat, fish and bread, it is possible to accelerate the process using the “Baking” mode and setting the temperature to 80°C-100°C.

Pre Set Temperature °C	Pre-set Cooking time (hh:mm)	Temperature Range °C	Maximum Cooking Time (hh:mm)
40	0:30	40-60	23:59



Dough Proving

In standby mode, place the dough to be fermented into the oven. Touch the Fermentation Mode Button , and touch the Temp/ Function Adjust Button or to set the desired time and temperature. Then touch the Start/Stop Button to begin.

Pre Set Temperature °C	Pre-set Cooking time (hh:mm)	Temperature Range °C	Maximum Cooking Time (hh:mm)
35	0:20	30-50	23:59



Plate Warming Mode

In standby mode, place the dishes in the oven. Touch the Warm Dish Mode Button , and press the Temp/ Function Adjust Button or to set the desired time and temperature. Then touch the Start/Stop Button to begin.

Pre Set Temperature °C	Pre-set Cooking time (hh:mm)	Temperature Range °C	Maximum Cooking Time (hh:mm)
70	0:30	30-70	23:59



Energy Saving Baking Mode

As per the Fan Forced function, the rear heating element and fan distribute heat uniformly throughout the oven.

By activating the heating element intermittently, the ECO mode reduces the amount of energy used by utilising the residual heat within the cavity to cook food more efficiently. This mode is ideal for baking and cooking delicate foods, such as cakes which need to rise or smaller amounts of vegetables, on up to 3 shelves at the same time.

Pre Set Temperature °C	Pre-set Cooking time (hh:mm)	Temperature Range °C	Maximum Cooking Time (hh:mm)
160	0:30	40-230	23:59

The oven light

To switch the light on/off, touch the Light Button. 

Cooling ventilation

In order to cool down the exterior of the appliance, this model is equipped with a cooling fan, which switches on automatically.

When the cooling fan is on, you will notice a flow of air exiting between the oven door and the control panel.

Note: When cooking is finished, the cooling fan continues to operate until the oven cools down and then switches off automatically.

PRACTICAL COOKING ADVICE

The oven offers a range of settings which allow you to cook any type of food in the best possible way. With time you will learn to make the best use of this versatile cooking appliance and the following directions are only a guideline which may be varied according to your own personal experience.

Preheating



See section on 'Rapid Heating' on page 14.

Note: Cooking times are approximate and may vary according to personal taste. When cooking using the grill or fan assisted grill, the dripping pan must always be placed on the 1st oven shelf from the bottom.

Practical Cooking Advice

The oven offers a wide range of alternatives which allow you to cook any type of food in the best possible way. With time you will learn to make the best use of this versatile cooking appliance and the following directions are only a guideline which may be varied according to your own personal experience.

Cooking on More Than One Rack

If you have to cook food using several racks, use either the “fan forced” mode  or the “multi cooking” mode , as these are the only modes that allow you to do so.



When cooking delicate food on more than one rack, use the “fan forced” mode, which allows you to cook on 3 racks at the same time (the 1st 3rd and 5th from the bottom). Some examples are included in the “Practical Cooking Advice” table.

When cooking other food on several racks, use the “multi cooking” mode keeping the following suggestions in mind:

- The oven is fitted with 5 racks. During fan assisted cooking, use two of the three central racks; the lowest and highest racks receive the hot air directly and therefore delicate foodstuffs could be burnt on these racks.
- As a general rule, use the 2nd and 4th rack from the bottom, placing the foodstuffs that require greater heat on the 2nd rack from the bottom. For example, when cooking meat roasts together with other food, place the roast on the 2nd rack from the bottom and the more delicate food on the 4th rack from the bottom.
- When cooking foodstuffs that require differing times and temperatures, set a temperature that is somewhere between the two temperatures required, place the more delicate food on the 4th rack from the bottom and take the food requiring less time out of the oven first.
- Use the dripping pan on the lower rack and the grid on the upper;

Using the Grill

This multi-function oven offers you 2 different grilling modes.

Use the “Half Grill / Full Grill” mode /, placing the food under the center of the grill (situated on the 3rd or 4th rack from the bottom)because only the central part of the top heating element is turned on.

Use the bottom rack (1st from the bottom), placing the dripping pan provided to collect any sauce and /or grease and prevent the same from dripping onto the oven bottom. When using this mode, we recommend you set the thermostat to the highest setting. However, this does not mean you cannot use lower temperatures, simply by adjusting the thermostat knob to the desired temperature.

Setting  “fan assisted grill”, is extremely useful for grilling foods rapidly, as the distribution of heat makes it possible not only to brown the surface, but also to cook the bottom part. Moreover, it can also be used for browning foods at the end of the cooking process, such as adding that gratin finish to pasta bakes, for example.

When using this mode, place the grid on the 2nd or 3rd oven rack from the bottom (see cooking table) then, to prevent fat and grease from dripping onto the bottom of the oven and thus smoke from forming, place a dripping-pan on the 1st rack from the bottom.

When using this mode, we advise you to set the thermostat to 200°C, as it is the most efficient way to use the grill, which is based on the use of infrared rays. However, this does not mean you cannot use lower temperatures, simply by adjusting the thermostat knob to the desired temperature.

Therefore the best results when using the grill modes are obtained by placing the grid on the lower racks (see cooking table) then, to prevent fat and grease from dripping onto the bottom of the oven and smoke from forming, place a dripping-pan on the 1st oven rack from the bottom. Always grill with the oven door closed.

Using the Air Fry

Use the “Air Fry” mode,  Put your food on the 3rd oven rack from the bottom. because the top and circle heating element is turned on, Air fry enables advanced convection cooking function without having to turn the food, giving crispy great tasting results in a shorter time without all the oil. This is suitable for french fries, chicken wings, nuggets and similar products, Put the grill dish on the lowest shelf position to catch any spills. When using “Air Fry” Set temperature to 230°C.

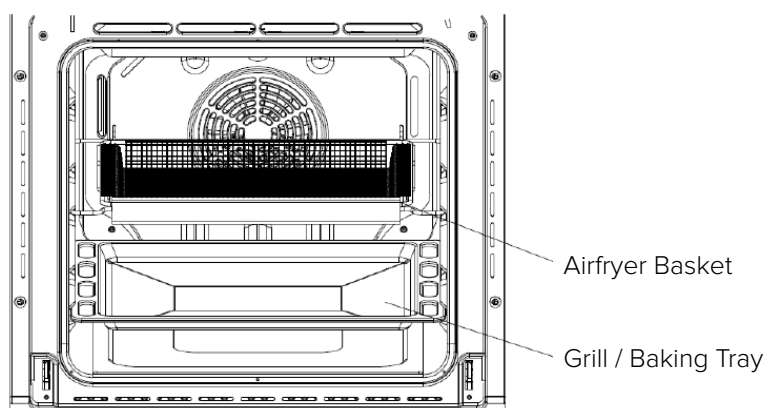

Baking cakes

When baking cakes, always place them in a preheated oven. Make sure you wait until the oven has been preheated thoroughly. To prevent heat loss and the cake from dropping, do not open the oven door during baking.

In general...

... if pastry is too dry

Increase the temperature by 10°C and reduce the cooking time.

... if pastry has dropped

Use less liquid or lower the temperature by 10°C.

... if pastry is too dark on top

Place it on a lower shelf, lower the temperature, and increase the cooking time.

... if cooked well on the inside but sticky on the outside

Use less liquid, lower the temperature, and increase the cooking time.

... if the pastry sticks to the pan

Grease the pan well and sprinkle it with a dusting of flour or use greaseproof paper.

... if I used multi shelf cooking and one shelf is more cooked

Use a lower temperature setting next time. It is not necessary to remove the food from all the racks at the same time.

Cooking Pizza

For best results when cooking pizza ,use the “**Pizza Mode**”: 

- Preheat the oven for at least 10 minutes;
- Use a light aluminum pizza pan, placing it on the grid supplied with the oven .If the dripping pan is used,
- this will extend the cooking time, making it difficult to get a crispy crust;
- Do not open the oven door frequently while the pizza is cooking ;
- If the pizza has a lot of toppings (three or four), we recommend you add the mozzarella cheese on top halfway through the cooking process.
- When cooking pizza on two racks, use the 2nd and 4th with a temperature of 220°C and place the pizzas in the oven after having preheated it for at least 10 minutes .

Cooking Fish and Meat





When cooking white meat, fowl and fish, use temperature setting from 180°C to 200°C.

For red meat that should be well done on the outside while tender and juicy in the inside ,it is a good idea to start with a high temperature setting (200°C-220°C)for a short time, then turn the oven down afterwards.



In general, the larger the roast, the lower the temperature setting. Place the meat on the center of the grid and place the dripping pan beneath it to catch the fat.

Make sure that the grid is inserted so that it is in the center of the oven. If you would like to increase the amount of heat from below, use the low rack heights .For savory roasts (especially duck and wild game), dress the meat with lard or bacon on the top.



Cooking Guide

Cooking mode	Food to be cooked	Weight (in kg)	Cooking rack position from bottom	Preheating time (Minutes)	Temperature setting °C	Cooking time (Minutes)
1 Conventional 	Duck	1	3	15	200	65-75
	Roast veal or beef	1	3	15	200	70-75
	Pork roast	1	3	15	200	70-80
	Biscuits (short pastry)	-	3	15	180	15 - 20
	Tarts	1	3	15	180	30-35
2 MultiCooking 	Pizza (on 2 racks)	1	2-4	15	220	15-20
	Lasagna	1	3	10	200	30-35
	Lamb	1	2	10	180	50-60
	Roast chicken +potatoes	1	2-4	10	180	60-75
	Mackerel	1	2	10	180	30-35
	Plum-cake	1	2	10	170	40 -50
	Cream puffs (on 2 racks)	0.5	2-4	10	190	20-25
	Biscuits (on 2 racks)	0.5	2-4	10	180	10- 15
	Sponge cake (on 1 rack)	0.5	2	10	170	15-20
	Sponge cake (on 2 racks)	1.0	2-4	10	170	20-25
	Savory pies	1.5	3	15	200	25-30
3 Grill 	Soles and cuttlefish	1	4	5	Max	8-10
	Squid and prawn kebabs	1	4	5	Max	6-8
	Cod filet	1	4	5	Max	10
	Grilled vegetables	1	3/4	5	Max	10-15
	Veal steak	1	4	5	Max	15-20
	Cutlets	1	4	5	Max	15-20
	Hamburgers	1	4	5	Max	7-10
	Mackerels	1	4	5	Max	15-20
Toasted sandwiches	-	4	5	Max	2-3	
4 Defrosting 	All frozen food					

USE AND CARE

5 Full Grill 	Soles and cuttlefish	1	4	5	200	8-10
	Squid and prawn kebabs	1	4	5	200	6-8
	Cod filet	1	4	5	200	10
	Grilled vegetables	1	3/4	5	200	10-15
	Veal steak	1	4	5	200	15-20
	Cutlets	1	4	5	200	15-20
	Hamburgers	1	4	5	200	7-10
	Mackerels	1	4	5	200	15-20
	Toasted sandwiches	-	4	5	200	2-3
	With rotisserie (where fitted)					
	Veal on the spit	1.0	-	5	200	80-90
	Chicken on the spit	1.5	-	5	200	70-80
	Lamb on the spit	1.0	-	5	200	70-80
6 Fan Assisted Grill 	Grilled chicken	1.5	3	5	200	55-60
	Cuttlefish	1.5	3	5	200	30-35
	With rotisserie (where fitted)					
	Veal on the spit	1.5	-	5	200	70-80
	Chicken on the spit	2.0	-	5	200	70-80
	Chicken (on the spit)+potatoes (roasted)	1.5	-	5	200	70-75
		-	2	5	200	70-75
	Lamb on the spit	1.5	-	5	200	70-80
7 Fan Forced 	Tarts	0.5	3	15	180	20-30
	Fruit cakes	1	2/3	15	180	40-45
	Fruitcake	0.7	3	15	180	40-50
	Sponge cake	0.5	3	15	160	25-30
	Stuffed pancakes (on 2 racks)	1.2	2-4	15	200	30-35
	Small cakes (on 2 racks)	0.6	2-4	15	190	20-25
	Cheese puffs (on 2 cakes)	0.4	2-4	15	210	15-20
	Cream puffs (on 3 cakes)	0.7	1-3-5	15	180	20-25
	Biscuits (on 3 racks)	0.7	1-3-5	15	180	20-25
	Meringues (on 3 racks)	0.5	1-3-5	15	90	180

USE AND CARE

8 Fan Assist 	Frozen food					
	Pizza	0.3	2	-	250	12
	Courgette and prawn pie	0.4	2	-	200	20
	Country style spinach pie	0.5	2	-	220	30-35
	Turnovers	0.3	2	-	200	25
	Lasagne	0.5	2	-	200	35
	Golden Rolls	0.4	2	-	180	25-30
	Chicken morseis	0.4	2	-	220	15-20
	Pre-cooked food					
	Golden chicken wings	0.4	2	-	200	20-25
	Fresh Food					
Biscuits(short pastry)	0.3	2	-	200	15-18	
Fruitcake	0.6	2	-	180	45	
Cheese puffs	0.2	2	-	210	10-12	
9 Pizza 	Pizza	0.5	3	15	220	15-20
	Roast veal or beef	1	2	10	220	25-30
	Chicken	1	2/3	10	180	60-70
10 Air Fry 	Scotch fillet steak, seared first	1	3	5	220	8
	Frozen chips	1	3	5	220	15
	Chicken drumettes/wingettes, with dry rub	1	3	5	230	15
	Fresh barramundi fillet with crumb	1	3	5	230	15
	Potatoes cut into wedges	0.5	3	5	230	14
	Frozen goods (Chicken nuggets/crumbed fish)	1	3	5	230	15
	Smashed chats parboiled	1.0	3	54	220	15

Note: Cooking times are approximate and may vary according to personal taste. When cooking using the grill or fan assisted grill, the dripping pan must always be placed on the 1st oven shelf from the bottom.

Cleaning and maintenance

Before cleaning your oven or performing maintenance, make sure that the oven is turned off. To extend the life of your oven, it must be cleaned frequently. The enamelled or stainless steel parts should be washed with lukewarm water without using any abrasive powders or corrosive substances. If any stainless steel has difficult to remove stains, use cleaners specifically recommended to clean stainless steel. After cleaning any surface, it is advisable to rinse thoroughly and dry. The inside of the oven should preferably be cleaned immediately after use, when it is still warm (but not hot), with warm water and soap. The soap should be rinsed away and the interior dried thoroughly. Avoid using abrasive detergents, scourers acidic cleaners such as lime scale remover, etc. as these could damage the enamel. If stains are particularly tough to remove, use cleaners specifically recommended to clean ovens and follow the instructions provided with the cleaner. **Never use a steam cleaner or caustic oven cleaners for cleaning inside the oven.**

If you operate your oven for an extended period of time, or if you are cooking dishes that contain a lot of water, condensation may form on the oven door. Dry it using a soft cloth and try reducing the cooking temperature. There is a seal surrounding the oven opening which is necessary to ensure the correct operation of the oven. Check the condition of this seal on a regular basis. If necessary, clean it but avoid using abrasive products or objects to do so. Should it become damaged, please contact Glen Dimplex Service Department. We recommend you avoid using the oven until it has been repaired.

Never place anything (including foil and oven trays) on the bottom of the oven when it is in operation because this could damage the enamel.

Clean the glass door using non-abrasive products or sponges and dry it with a soft cloth.



Do not use harsh abrasive cleaners or sharp metal scrapers to clean the oven door glass since they can scratch the surface, which may result in shattering of the glass.

Use only non caustic oven cleaners purchased from hardware stores or supermarkets.

Steam Assisted Cleaning function

This function assists in the removal of food residue from inside the oven. This method is effective in removing light soiling only. It is not effective in removing stubborn baked-on stains. This function can only be used when the oven is cold.

Procedure for cleaning

1. Remove all shelves, dishes and side racks.
2. Make a solution of water (85%), white vinegar (10%), and dish washing detergent (5%) and spray liberally on to door, side walls and back wall of oven cavity.
3. Pour 40ml of water into the cavity base well.
4. Close the door. Touch the Steam Assist Clean Button  and then use the Temp /Function Adjust Button  or  to set the temperature to 130C
5. Turn the oven OFF after 18 minutes.
6. Allow to cool to a safe level before wiping surface with a damp cloth.

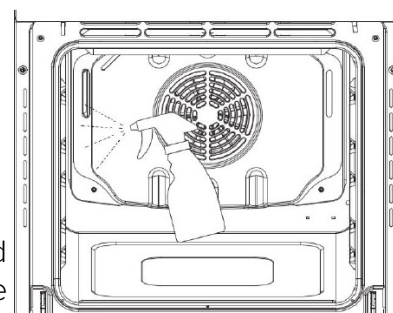

How to remove the oven door

You can remove the oven door for better access to the oven when cleaning. Proceed as follows to remove the door:

- Open the door fully (1).
- Lift up and turn the latch situated on each of the two hinges (2).
- Grip the door on the two external sides and close it approximately 3/4 way (3).
- Pull the door up towards you, lifting it out of the oven frame (4).
- To replace the door, use the reverse procedure.

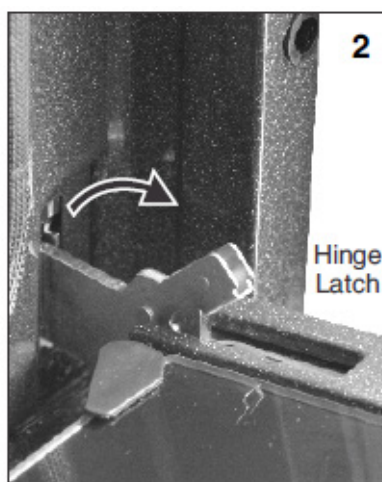

How to dismantle the oven door for cleaning

You can remove the inner door glass for better cleaning. Proceed as follows to remove the inner door glass:

- Remove the trim 'G' by unscrewing the 2 screws (fig.1)
- Gently slide out the inner pane of glass (fig.2)
- Clean the glass with an appropriate cleaner. Dry thoroughly and place on a soft surface.
- Now you can also clean the inside of the outer glass.
- Use the reverse procedure to re-assemble the door glass.

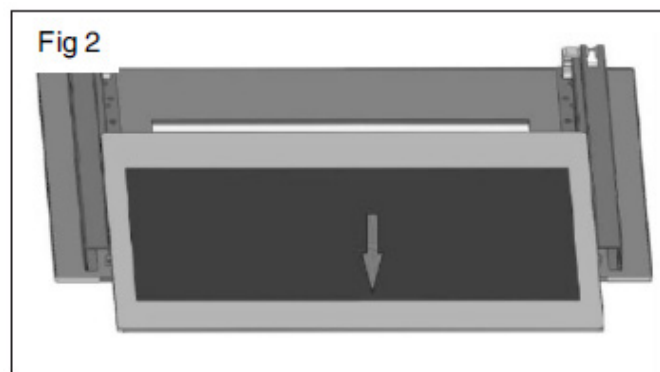
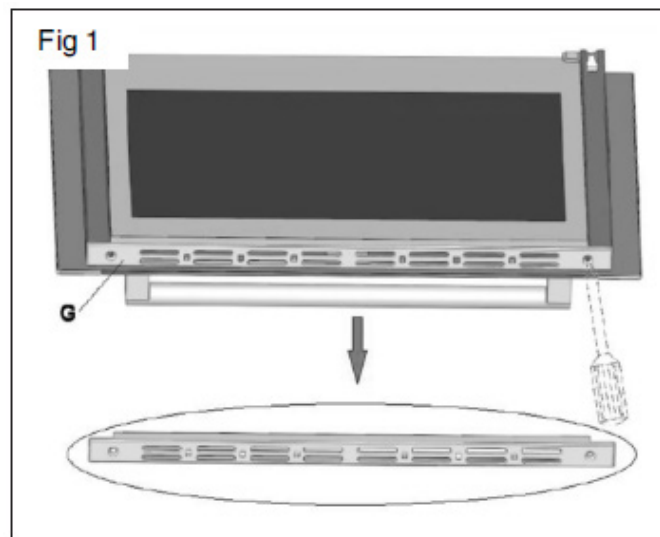

Troubleshooting

Problem	Possible cause and remedy
The oven does not heat up	<ul style="list-style-type: none">-The oven may not be switched on. Switch the oven on.-The clock may not be set. Set the clock.-Check to see if the required settings have been applied.-A household fuse may have blown or a circuit breaker may have tripped. Replace the fuses or reset the circuit. If this happens repeatedly, call an authorised electrician.
A noise can be heard after a cooking programme	The cooling fan remains switched on after the end of a cooking programme.
Cakes and biscuits are browning unevenly	There will always be a slight unevenness. If browning is very uneven check that the correct temperature was set and that the correct shelf level was used.
A fault code appears in the display:HE1	<ul style="list-style-type: none">■ Temperature sensor error■ Call local service centre
A fault code appears in the display:HE2	<ul style="list-style-type: none">■ Probe temperature sensor error■ Call local service centre

Replacing the oven lamp

WARNING: Ensure that the appliance is switched off before replacing the lamp to avoid the possibility of electric shock. Remove the glass cover of the lamp-holder as shown below.

Remove the lamp and replace with a lamp resistant to high temperatures (300°C) with the following characteristics:

- Voltage: 220-240V
- Wattage: 25W
- Type: E 14

Replacement lamps are available from Glen Dimplex. Replace the glass cover and reconnect the oven to the mains power supply.

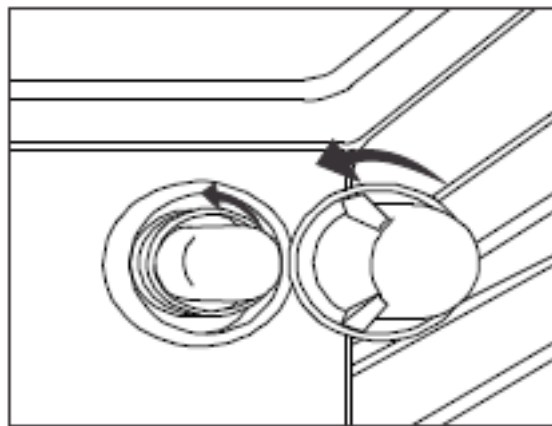

Disposal

By ensuring this product is disposed of correctly, you will help prevent potential negative consequences for the environment and human health, which could otherwise be caused by inappropriate waste handling of this product.

The symbol on the product indicates that this product may not be treated as household waste. Instead it shall be handed over to the applicable collection point for the recycling of electrical and electronic equipment.

Disposal must be carried out in accordance with local environmental regulations for waste disposal.

For more detailed information about treatment, recovery and recycling of this product, please contact your local city council office.

IMPORTANT: Installation, assembly and electrical connections must be carried out by authorised personnel.

Cabinet details

In order to ensure that the built-in appliance functions properly, the cabinet containing it must be appropriate. The figure below gives the dimensions of the cut-out for installation under the counter or in a wall cabinet unit.

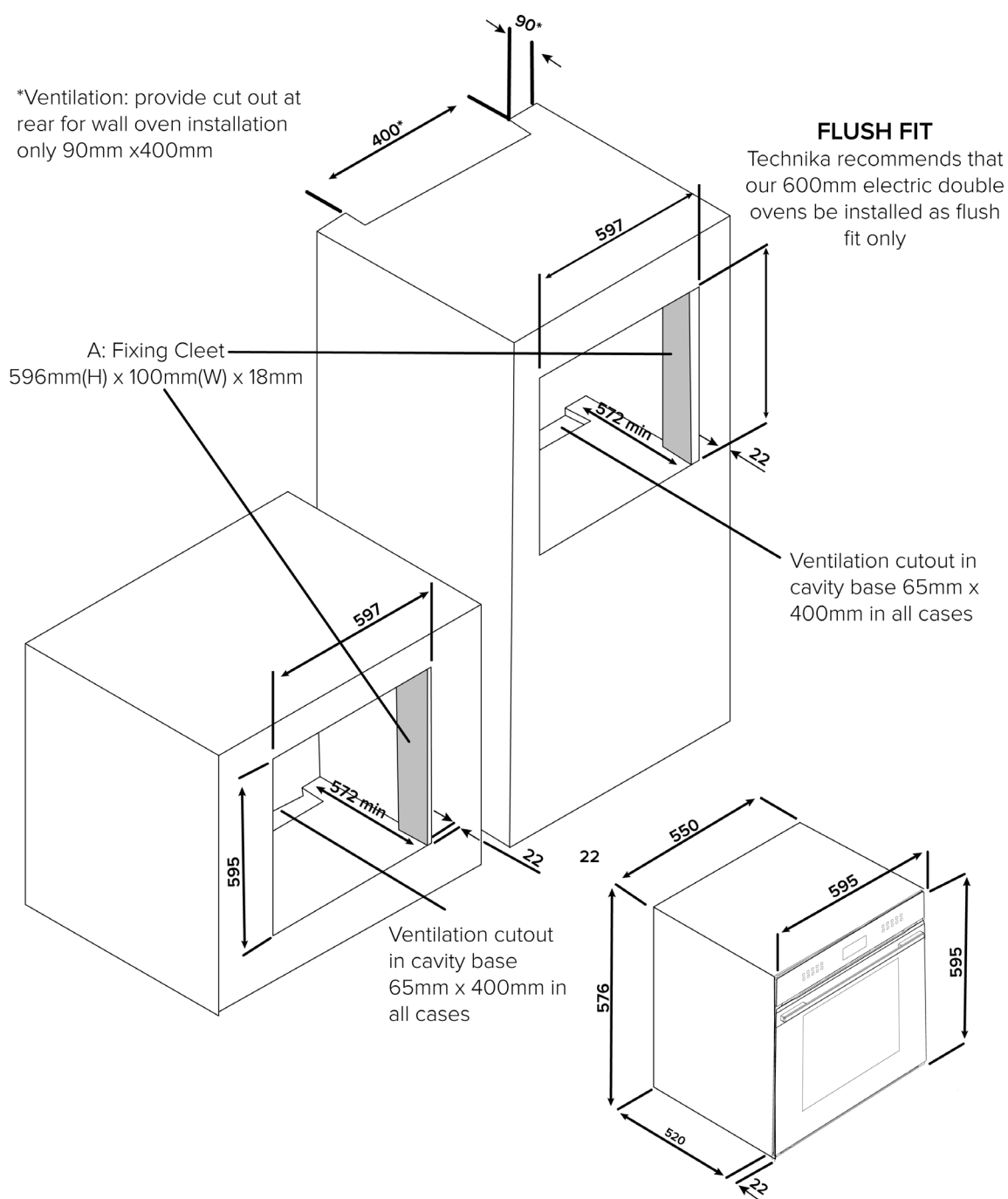

The panels of the adjacent cabinets must be made of heat resistant material. In particular, cabinets with a veneer exterior must be assembled with glues which can withstand temperatures of up to 75°C.

In compliance with current safety standards, contact with the electrical parts of the oven must not be possible once it has been installed.

All parts, which ensure the safe operation of the appliance, must be removable only with the aid of a tool.

To fasten the oven to the cabinet, open the door of the oven and attach it by inserting the 4 wood screws into the 4 holes located on the perimeter of the frame.

Electrical connection

The appliance is usually supplied fitted with a power cord and 3 pin plug. Install the cooker so that the plug is easily accessible. Plug the 3-pin plug into a properly earthed, 15A general purpose power outlet preferably on a separate dedicated circuit. The supply cable should be positioned so that it does not reach a temperature of more than 75°C along its entire length. If the appliance is not supplied with a plug or if connecting the cable directly to the mains, connection to the electricity supply must be made by an authorised person in accordance with the Wiring Rules AS/NZS3000. The installation must include a suitable isolating switch with a minimum contact opening of 3mm between the appliance and the mains. The isolating switch should be sized according to the load on the data label and should comply with current regulations (the earth wire should not be interrupted by the circuit breaker).

Before making the connection check that:

- the switch, wiring and electrical system can support the appliance load (see data plate);
- the power supply system has an efficient earthing connection
- which complies with the provisions of current regulations;
- the power outlet or omnipoar circuit-breaker is easily accessible once the cooker has been installed.

Replacing the power supply lead

If the supply cord or plug is damaged, it must be replaced by the manufacturer or its service agent or a similarly qualified person in order to avoid hazard.

Warning:

All electrical connections must be made by a suitably qualified and licenced person in accordance with local regulations.

Glen Dimplex will not be held responsible for damages caused to cabinetry due to incorrect installation.

Technical data

Inner dimensions of the oven:

Width: 42.3cm

Depth: 40.7cm

Height: 39.2cm

Gross Oven Volume: 85. litres

Voltage and Frequency of Power Supply:

220-240V, 50-60Hz

MANUFACTURER GUARANTEE

This warranty is provided in Australia by Glen Dimplex Australia Pty Limited ABN 69 118 275 460 **(Phone number 1300 556 816)** and in New Zealand by Glen Dimplex New Zealand Limited NZBN 9429000069823 **(Phone number 09 274 8265)** in respect of the **Technika Professional** product.

1. Technika Professional Express Warranty

Subject to the exclusions below, we warrant that the product will not have any electrical or mechanical breakdowns within:

- a) In the case of **Technika Professional** products used for personal, domestic or household purposes, a period of 2 years from the date the product is purchased as a brand-new product from a retailer located in Australia / New Zealand.
- b) In the case of **Technika Professional** products used for purposes other than personal, domestic or household purposes (including business or commercial use), a period of 90 days from the date the product is purchased as a brand-new product from a retailer located in Australia / New Zealand. **Technika Professional** products are designed and intended for domestic use only; and
- c) All warranty repairs must be carried out by Glen Dimplex or their nominated service agent

Note: warranty periods detailed above may vary in line with agreements with select retail and builder partners and may differ between Australia and New Zealand.

The benefits conferred by this express warranty are in addition to the Consumer Guarantees referred to in section 3 and any other statutory rights you may have under the Australian / New Zealand Consumer Law and/or other applicable laws.

2. Warranty exclusions

This express warranty does not apply where:

- a) The product has been installed, used or operated otherwise than in accordance with the product manual or other similar documentation provided to you with the product;

MANUFACTURER GUARANTEE

- b) The product requires repairs due to damage resulting from accident, misuse, incorrect installation, insect or vermin infestation, improper liquid spillage, cleaning or maintenance, unauthorised modification, use on an incorrect voltage, power surges and dips, voltage supply problems, tampering or unauthorised repairs by any persons, use of defective or incompatible accessories or exposure to abnormally corrosive conditions, events independent of human control which occurred after the goods left the control of Glen Dimplex;
- c) The repair relates to the replacement of consumable parts such as fuses and bulbs or any other parts of the product which require routine replacement;
- d) You are unable to provide us with reasonable proof of purchase for the product;
- e) the breakdown occurs after the expiry of the express warranty period set out in section 1 or
- f) the product was not purchased in Australia / New Zealand as a brand-new product.

3. Consumer guarantees

Our goods come with guarantees that cannot be excluded under the Australian / New Zealand Consumer Law. You are entitled to a replacement or refund for a major failure and for compensation for any other reasonably foreseeable loss or damage. You are also entitled to have the goods repaired or replaced if the goods fail to be of acceptable quality and the failure does not amount to a major failure.

4. How to make a claim

You may make a claim under this warranty through our website, contacting our customer care line or via email. Contact details for Glen Dimplex Australia and New Zealand can be found at the end of this document

To make a valid claim under this warranty, you must:

- a) Lodge the claim with us as soon as possible and no later than 14 days after you first become aware of the breakdown;
- b) Provide us with the product serial number;
- c) Provide us with reasonable proof of purchase for the product. This can take the form of a store receipt, new home handover form or other payment receipt documentation; and
- d) If required by us, provide us (or any person nominated by us) with access to the premises at which the product is located at times nominated by us (so that we can inspect the product).

MANUFACTURER GUARANTEE

5. Warranty claims

If you make a valid claim under this warranty and none of the exclusions set out in section 2 apply, we will, at our election, either repair the product or replace the product with a product of identical specification (or where the product is superseded or no longer in stock, with a product of as close a specification as possible).

Goods presented for repair may be replaced by refurbished goods of the same type rather than being repaired. Refurbished parts may be used to repair the goods.

Products are designed and supplied for normal domestic use. We will not be liable to you under this warranty for business loss or damage of any kind whatsoever.

Glen Dimplex Australia Pty Ltd

www.glendimplex.com.au

Australia

Ph: 1300 556 816

customer.care.ha@glendimplex.com.au

Glen Dimplex New Zealand Ltd

www.glendimplex.co.nz

New Zealand

Ph: 09 274 8265

nztechserv@glendimplex.co.nz

MANUFACTURER GUARANTEE

READ THE INSTRUCTION BOOKLET BEFORE INSTALLING AND USING THE APPLIANCE.

The manufacturer will not be responsible for any damage to property or to persons caused by incorrect installation or improper use of the appliance.

The manufacturer is not responsible for any inaccuracies, due to printing or transcription errors, contained in this manual. In addition, the appearance of the figures reported is also purely indicative.

The manufacturer reserves the right to make changes to its products when considered necessary and useful, without affecting the essential safety and operating characteristics.

Glen Dimplex constantly seeks ways to improve the specifications and designs of their products.

Whilst every effort is made to produce up to date literature, this document should not be regarded as an infallible guide. Actual product only should be used to derive cut out sizes.

All appliances must be installed by a qualified person/s with adherence to the relevant electrical, plumbing and building codes, with compliance being issued as required by state or national legislation.

Additionally, all upright cookers must have the anti-tilt device installed correctly in adherence to the relevant standards by a licenced installer. For maximum effectiveness and efficiency all rangehoods should be installed with the use of ductwork, by a licenced installer with adherence to the relevant state and national building codes and regulations.

All Glen Dimplex appliances are for Domestic use only, and must be installed by a licence installer into Domestic Applications only, without exception and to the required Authorities guidelines. Any installation outside of this will VOID warranty. Alfresco areas are not a Domestic application.



Distributed by:

Glen Dimplex Australia Pty Ltd

For full terms and conditions, or to register your product warranty, please visit our website:

www.glendimplex.com.au

Glen Dimplex New Zealand Ltd

www.glendimplex.co.nz

For service advice, please contact the Customer Care Centre by phone or email below.

Australia

Ph: 1300 556 816

customer.care.ha@glendimplex.com.au

New Zealand

Ph: 09 274 8265

nztechserv@glendimplex.co.nz