

the Bambino™

Instruction Book - BES450



Breville®



Contents

2	Breville Recommends Safety First
8	Components
10	Features
10	Assembly
11	Functions
16	Care & Cleaning
19	Troubleshooting

BREVILLE RECOMMENDS SAFETY FIRST

At Breville we are very safety conscious. We design and manufacture consumer products with the safety of you, our valued customer, foremost in mind. In addition, we ask that you exercise a degree of care when using any electrical appliance and adhere to the following precautions.

IMPORTANT SAFEGUARDS

READ ALL INSTRUCTIONS BEFORE USE AND SAVE FOR FUTURE REFERENCE

- Carefully read all instructions before operating and save for future reference.
- Remove any packaging material and promotional labels or stickers before using the appliance for the first time.
- To eliminate a choking hazard for young children, remove and safely discard the protective cover fitted to the power plug of this appliance.
- Do not touch hot surfaces. Use handles or knobs as advised in this instruction book.
- To protect against fire, electric shock and injury to persons do not immerse the power cord, plug, or appliance itself in water or other liquids.

- This appliance can be used by children aged from 8 years and above if they have been given supervision or instruction concerning use of the appliance in a safe way and understand the hazards involved.
- Cleaning and user maintenance shall not be made by children unless they are aged from 8 years and above and supervised.
- Keep the appliance and its cord out of reach of children aged less than 8 years.
- Appliances can be used by persons with reduced physical, sensory or mental capabilities or lack of experience and knowledge if they have been given supervision or instruction concerning use of the appliance in a safe way and understand the hazards involved.
- Children shall not play with the appliance.
- Close supervision is necessary when any appliance is used by or near children.
- Unplug from outlet when not in use and before cleaning. Allow to cool before putting on or taking off parts and before cleaning the appliance.
- It is recommended to regularly inspect the appliance and power cord. Do not use the appliance if there is damage to the power cord or plug, or after the appliance malfunctions or has been damaged in any way. Immediately stop use and call Breville Consumer Support.
- The use of accessory attachments not recommended by Breville may result in fire, electric shock or injury to persons.
- Do not use the Bambino™ inside a cabinet.

- Do not place the appliance near the edge of a table or counter-top. Ensure the surface is level, clean and free of water and other substances.
- Do not let the power cord hang over the edge of a bench or table or become knotted.
- Do not place the appliance on or near a hot gas or electric burner.
- Do not place it in or allow it to come in contact with a heated oven.
- This appliance is recommended for household use only. Do not use this appliance for anything other than its intended use. Do not use outdoors. Do not use in moving vehicles or boats.
- Keep the appliance and accessories clean. Follow the cleaning instructions provided in this book.
- Any procedure not listed in this instruction booklet should be performed at an authorised Breville Service Centre.
- The installation of a residual current device (safety switch) is recommended to provide additional safety protection when using electrical appliances. It is advisable that a safety switch with a rated residual operating current not exceeding 30mA be installed in the electrical circuit supplying the appliance. See your electrician for professional advice.

NOTICE TO CUSTOMERS REGARDING MEMORY STORAGE

• Please note that in order to better serve our customers, internal memory storage has been imbedded into your appliance. This memory storage consists of a small chip to collect certain information about your appliance including the frequency of use of the appliance and the manner in which your appliance is being used. In the event your appliance is returned for service, the information collected from the chip enables us to quickly and efficiently service your appliance. The information collected also serves as a valuable resource in developing future appliances to better serve the needs of our consumers. The chip does not collect any information regarding the individuals who use the product or the household where the

product is used. If you have any questions regarding the memory storage chip, please contact us at privacy@breville.com

SPECIFIC INSTRUCTIONS FOR BES450

- This appliance is recommended for household use only. Do not use this appliance for other than its intended use. Do not use in moving vehicles or boats. Do not use outdoors. Misuse may cause injury.
- If the appliance is to be:
 - left unattended
 - cleaned
 - moved
 - assembled; or
 - stored,always switch Off the espresso machine by simultaneously pressing the 1 CUP and HOT WATER buttons. Unplug from the power outlet.

- Ensure the product is properly assembled before first use.
- Do not use any other liquid apart from cold mains/tap water. We do not recommend the use of highly filtered, de-mineralized or distilled water as this may affect the taste of the coffee and how the espresso machine is designed to function.
- Do not leave the product unattended when in use.
- Do not touch hot surfaces. Allow the product to cool down before moving or cleaning any parts.
- Use caution when operating the machine, as metal surfaces are liable to get hot during use.

 **WARNING**

To avoid the risk of injury, use caution when descaling, as hot steam may be released. Before descaling, ensure drip tray

is inserted. Refer to 'Care & Cleaning' for further instructions.

Ensure the portafilter is firmly inserted and secured into the group head before starting the extraction.

Never remove the portafilter during the brewing process.

 **WARNING**

To avoid the risk of injury, do not open the brew chamber during the brew process.

 **WARNING**

Do not place portafilter, the tamper or any parts of the appliance in the dishwasher.

 **WARNING**

Do not immerse power cord, power plug or any parts of the appliance or the appliance in water or any other liquid.

 **WARNING**

Misuse may cause injury.

SHORT CORD INSTRUCTIONS

- Your Breville appliance is fitted with a short power cord to reduce personal injury or property damage resulting from pulling, tripping or becoming entangled with a longer cord. Longer detachable power cords or extension cords are available and may be used if care is exercised. If an extension cord is used,
 1. the marked electrical rating of the cord set, or extension cord should be at least as great as the electrical rating of the appliance,

2. the cord should be arranged so that it will not drape over the counter-top or table where it can be pulled on by children or tripped over unintentionally and
3. the extension cord must include a 3-prong grounding plug.

BREVILLE ASSIST™ PLUG

- Your Breville appliance comes with a unique Assist™ Plug, conveniently designed with a finger hole to ease removal from the power outlet.

**FOR HOUSEHOLD USE ONLY
SAVE THESE INSTRUCTIONS**



Components

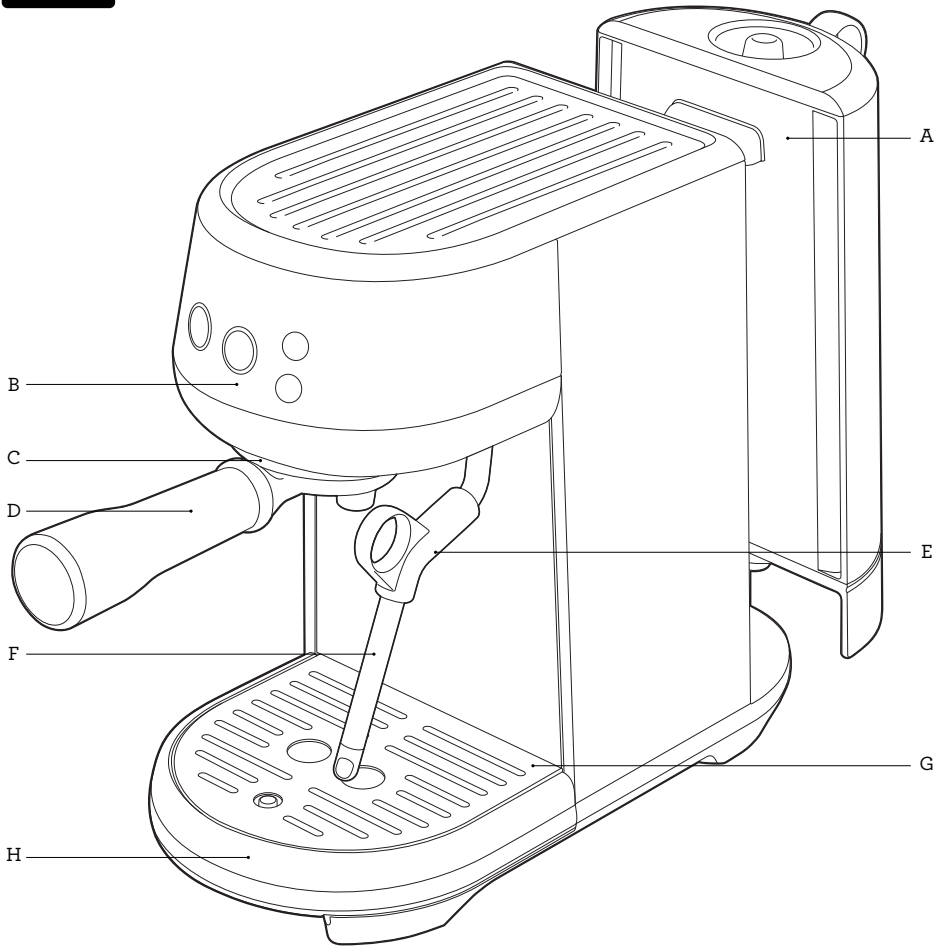

- A. 1.4L (47 fl.oz) removable water tank
- B. Control panel
1 CUP, 2 CUP, hot water, steam buttons
- C. Group head
- D. 54mm aluminum portafilter
(WARNING: NOT dishwasher safe)

- E. Steam wand grip
- F. Steam wand
- G. Removable drip tray grid
- H. Removable drip tray with full indicator

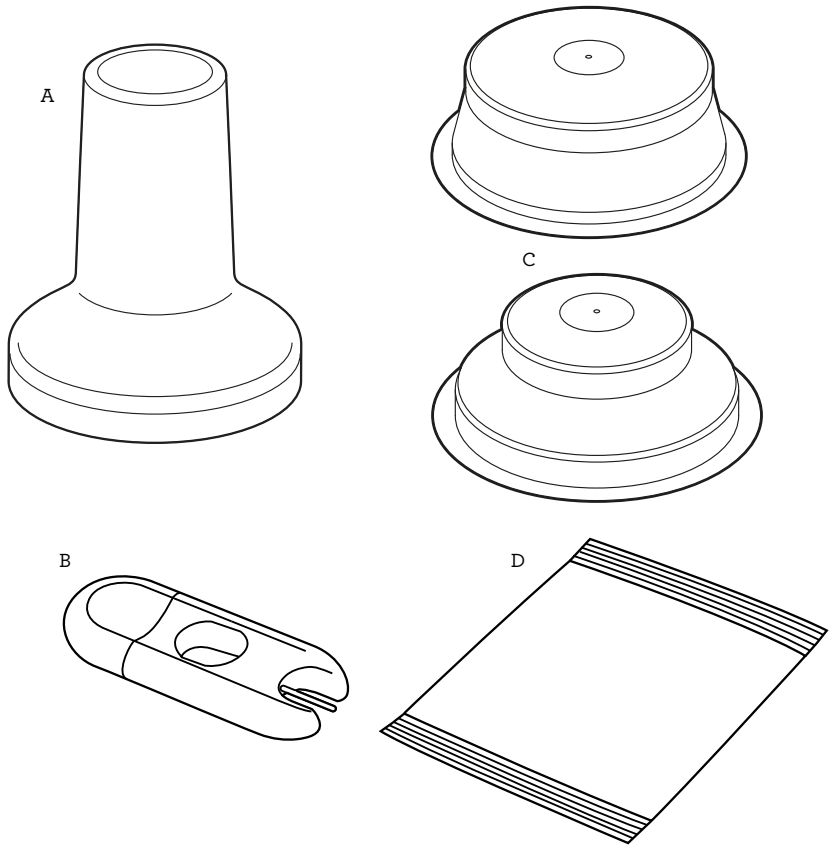

ACCESSORIES

- A. 54mm tamper
(Note: Do not submerge in water or any liquid)
- B. Steam tip and basket cleaning tool
(Located under the water tank)
- C. Dual wall filter baskets (1 cup & 2 cup)
- D. Descaling powder



Bambino™ Features

COMPACT FOOTPRINT

Cafe quality coffee in a compact machine.

MANUAL MILK TEXTURING

Manually textures milk from silky smooth latté to creamy cappuccino.

THERMOJET™ TECHNOLOGY

Innovative heating system achieves ideal extraction temperature in 3 seconds.

PID TEMPERATURE CONTROL

Electronic PID temperature control for increased temperature stability.

LOW PRESSURE PRE-INFUSION

Applies low water pressure at the start of the extraction to gently expand grinds for an even extraction.

VOLUMETRIC CONTROL

Preset 1 & 2 cup volumes, manual over-ride or programmable shot volumes.

INSTANT HOT WATER

Hot water outlet via the steam wand for making long blacks and pre-heating cups.



Assembly

BEFORE FIRST USE

Machine Preparation

Remove and discard all labels and packaging materials attached to your machine. Ensure you have removed all parts and accessories before discarding the packaging.

Clean the drip tray, drip tray grid, portafilter, filter baskets using warm water and a gentle dish washing liquid. Rinse well and dry thoroughly before use.



Functions

FIRST USE

1. Remove the water tank and fill it with potable water to the indicated MAX line. Place the water tank back firmly onto the machine.
2. Ensure that the drip tray is firmly placed on the machine.
3. Place a 500ml container under the portafilter and steam wand for the water drips for this first cycle.
4. Plug the power cord into the power outlet.

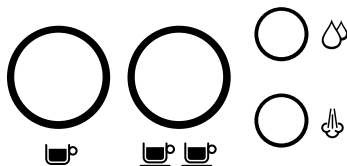

5. Press the 1 Cup or 2 Cup or Steam or Hot water buttons to turn the machine on.



NOTE

The first use cycle is to rinse the machine and prime the heating system.

STANDBY MODE

To turn off the operation and enter standby mode, press the 1 Cup and Hot Water buttons for 0.5 second simultaneously.



NOTE

Unit will enter 'standby mode' when idle or no interaction from user after 10 minutes.

FILLING THE WATER TANK

Lift the water tank from the machine. Remove the water tank lid and add potable water to the water tank, filling to the MAX marking indicated.

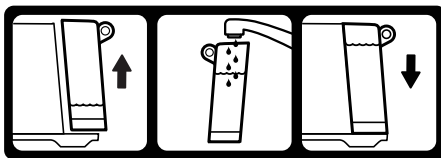

Replace the water tank onto the machine, press down ensuring it is properly attached and sitting flush against the back of the machine.



NOTE

Machine LED lights will flash 6 times for 3 seconds when no water is detected in the water tank.

FILTER BASKETS

This machine includes dual wall 1 Cup and 2 Cup filter baskets.

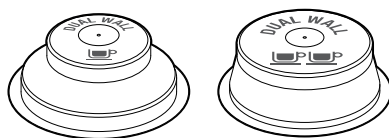

1 CUP

2 CUP

Use the 1 cup filter basket when brewing a single cup and the 2 cup filter baskets when brewing 2 cups or a stronger single cup or mug.

You will need to adjust the grind amount and size if switching from a single basket to a double basket, or vice versa.

The provided filter baskets are designed for:

1 Cup filter basket = 8-11g

2 Cup filter basket = 16-19g

THE GRIND

When grinding coffee beans, the grind size should be fine but not too fine. The grind size will affect the rate at which the water flows through the ground coffee in the filter basket and the taste of the espresso.

If the grind is too fine (looks like powder and feels like flour when rubbed between the fingers), the water will not flow through the coffee even when under pressure. The resulting espresso will be **OVER EXTRACTED**, dark in colour and bitter in flavour.

If the grind is too coarse, the water will flow through the ground coffee in the filter basket too quickly. The resulting espresso will be **UNDER EXTRACTED** and lacking in colour and flavour.

COFFEE DOSE AND TAMPING

- Insert the filter basket into the portafilter.
- Grind enough coffee to fill the filter basket.
- Tap the portafilter several times to collapse and distribute the coffee evenly in the filter basket.
- Using the tamper, tamp down firmly (approx. 15-20kgs (30-40 lbs.) of pressure). The amount of pressure is not as important as the consistent pressure every time.

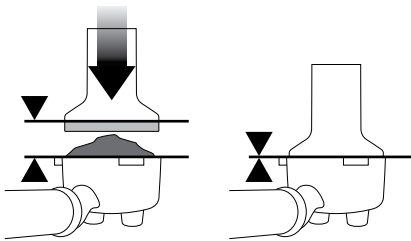

As a guide, the top edge of the cap on the tamper should be level with the top of the filter basket **AFTER** the coffee has been tamped.

NOTE

We recommend quality 100% Arabica beans with a 'Roasted On' date stamped on the bag, not a 'Best Before' or 'Use By' date. Coffee beans are best consumed between 5-20 days after the 'Roasted On' date. Stale coffee may pour too quickly from the portafilter spouts and taste bitter and watery.

PURGING THE GROUP HEAD

Before placing the portafilter into the group head, run a short flow of water through the group head by pressing the 1 Cup or 2 Cup button. This will stabilize the temperature prior to extraction.

INSERTING THE PORTAFILTER

Place the portafilter underneath the group head so that the handle is aligned with the **INSERT** position. Insert the portafilter into the group head and rotate the handle towards the centre until resistance is felt.

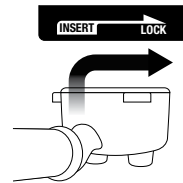

Place your cup/s under the portafilter on the drip tray.

EXTRACTING ESPRESSO

As a guide the espresso will start to flow after 8-10 seconds (infusion time) and should be the consistency of dripping honey.

If the espresso starts to flow after less than 6 seconds, you have either under dosed the filter basket and /or the grind is too coarse. This is an **UNDER EXTRACTED** shot.

If the espresso starts to drip but doesn't flow after 15 seconds, the grind is too fine. This is an **OVER EXTRACTED** shot.

PRE-PROGRAMMED SHOT VOLUME - 1 CUP

Press the 1 Cup button for less than 1 second, the button will flash indicating that it has been selected. A preset single espresso volume of approximately 30ml will be extracted. The machine will automatically stop once the pre-set volume has been extracted.

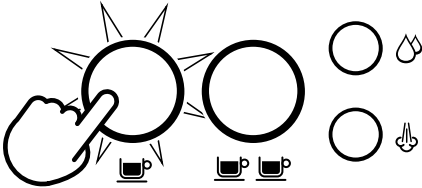

PRE-PROGRAMMED SHOT VOLUME - 2 CUP

Press the 2 Cup button for less than a second, the button will flash indicating that it has been selected. A preset double espresso volume of approximately 60ml will be extracted. The machine will automatically stop once the pre-set volume has been extracted.

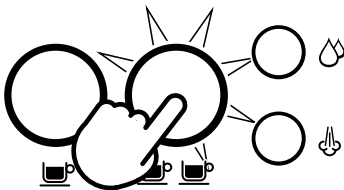

NOTE

Pressing the corresponding 1 Cup or 2 Cup button during the programmed espresso extraction will immediately stop the extraction.

PROGRAMMING COFFEE VOLUME

Press and hold the 1 Cup and 2 Cup buttons for 2 seconds, the buttons will illuminate and flash.



To set the 1 Cup volume:

- Press the 1 Cup button for about 3 seconds to start the extraction.
- Press the 1 Cup button again to stop the extraction. The modified volume will be saved.

To set the 2 Cup volume, follow the above steps and select the 2 Cup button to start and stop the extraction.



NOTES

- If no user input after 30 seconds. Machine returns to 'ready mode'
- The modified coffee volume will be saved into memory for the next use or when the machine is re-started.
- Pressing the steam or hot water button at any stage will cancel the operation and the machine will return to ready mode without saving any coffee volume program.

MANUAL PRE-INFUSION AND SHOT VOLUME

Press and hold the 1 Cup or 2 Cup button for more than a second. After one second the pump will start at pre-infusion pressure and continue while button is pressed. Release the button to start the extraction. Press any button again to stop the extraction.

MANUAL MILK TEXTURING

- Lift the steam wand and insert into the milk jug with the steam wand tip 1-2cm ($\frac{3}{4}$ inch) below the surface of the milk, close to the right-hand side of the jug at a 3 o'clock position.
- Press the STEAM button to begin texturing

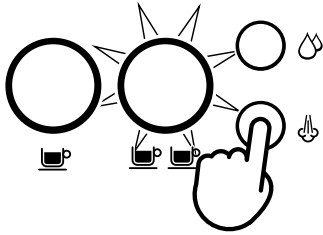

- Keep the steam wand tip just under the surface of the milk until the milk is spinning clockwise, producing a vortex (whirlpool effect).
- With the milk spinning, slowly lower the jug. This will bring the steam wand tip to the surface of the milk and start to introduce air into the milk.
- Gently break the surface of the milk with the tip to get the milk spinning fast enough.
- Keep the steam wand tip at or slightly below the surface, continuing to maintain the vortex. Texture the milk until sufficient volume is obtained.
- Lift the jug to lower the tip beneath the surface but keep the vortex spinning. The milk is at the correct temperature (60-65°C) when the jug is hot to touch.



- When texturing is close to acceptable desired result, press any button to stop texturing.
- After the steam is released completely, remove the steam wand from the milk jug.
- Wipe the wand and tip with a clean damp cloth.

STEAM WAND MANUAL PURGE

To reduce steam wand blockages, we recommend running steam through the steam wand after milk texturing. Lower and point steam wand directly on drip tray and away from users and press the steam button to run steam to rinse steam wand, or press and hold steam button for 3 seconds, to activate the steam wand purge. This will run short water pulses through the steam wand.



NOTE

Both 1 Cup and 2 Cup buttons will blink during the steam purge function.



WARNING

After pressing steam button, the steam can't stop immediately, it needs a few seconds to completely stop steam.

STEAM WAND BLOCKED

Regularly check steam performance. If the steam wand is blocked, it will immediately stop operating. See 'Cleaning the Steam Wand' for further instructions.

HOT WATER OPERATON

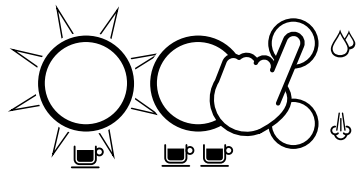

Hot water through the steam wand

When machine is on 'ready mode', press hot water button, and hot water flow will start through the steam wand. Press any button to stop hot water flow.





WARNING

Cup temperature is at 90°C (194°F). Be careful in handling hot beverages.

EXTRACTION TIPS

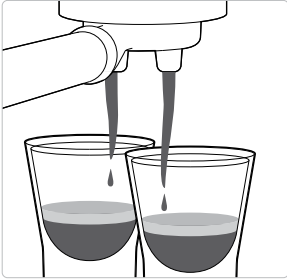
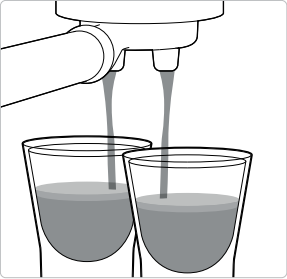
A great espresso is about achieving the perfect balance between sweetness, acidity, and bitterness. The flavour of your coffee will depend on many factors, such as the type of coffee beans, degree of roast freshness, coarseness or fineness of the grind, dose of ground coffee and tamping pressure. Experiment by adjusting these factors just one at a time to achieve the taste of your preference.

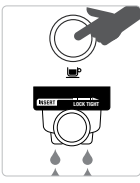
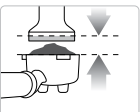
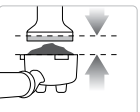
CORRECT EXTRACTION	UNDER EXTRACTION	OVER EXTRACTION
		
<ul style="list-style-type: none"> • Flow starts after 8–12 secs • Flow slow like warm honey • Crema is golden brown with a fine mousse texture • Espresso is dark brown 	<ul style="list-style-type: none"> • Flow starts after 1–6 secs • Flow fast like water • Crema is thin and pale • Espresso is pale brown • Tastes bitter/sharp, weak and watery 	<ul style="list-style-type: none"> • Flow starts after 15 secs • Flow drips or not at all • Crema is dark and spotty • Espresso is very dark brown • Tastes bitter and burnt
<p>AFTER EXTRACTION</p> <div data-bbox="101 815 241 991">  <p>REMOVE USED GRINDS Used grinds will form a coffee 'puck'. If the puck is wet, refer to the 'Under Extraction' section.</p> </div> <div data-bbox="101 999 241 1182">  <p>RINSE FILTER BASKET Keep the filter basket clean to prevent blockages. Without ground coffee in the filter basket, lock the portafilter into the machine and run hot water through.</p> </div>	<p>SOLUTIONS</p> <div data-bbox="417 815 704 991"> <p>EXPERIMENT WITH GRIND:</p> <ul style="list-style-type: none"> • Grind needs to be finer for a slower extraction. • Ensure you are controlling the dose. <p>Adjust & re-test</p> </div> <div data-bbox="417 999 704 1182">  <p>ALWAYS TAMP TO LINE</p> <p>Adjust & re-test</p> <p>Tamp using 15–20kgs of pressure. The top edge of cap on the tamper should be level with the top of the filter basket AFTER tamping.</p> </div>	<p>SOLUTIONS</p> <div data-bbox="733 815 1020 991"> <p>EXPERIMENT WITH GRIND:</p> <ul style="list-style-type: none"> • Grind needs to be coarser for a faster extraction. • Ensure you are controlling the dose. <p>Adjust & re-test</p> </div> <div data-bbox="733 999 1020 1182">  <p>ALWAYS TAMP TO LINE</p> <p>Adjust & re-test</p> <p>Tamp using 15–20kgs of pressure. The top edge of cap on the tamper should be level with the top of the filter basket AFTER tamping.</p> </div>

	GRIND	GRIND DOSE	TAMP
OVER EXTRACTED BITTER • ASTRINGENT	Too fine	Too much Decrease dose	Too heavy
BALANCED	Optimum	8-11g (1 Cup) 16-19g (2 Cup)	15-20kgs (30-40 lbs.)
UNDER EXTRACTED UNDERDEVELOPED • SOUR	Too coarse	Too little Increase dose	Too light



Care & Cleaning

++ CLEAN & DESCALE CYCLE

When descale cycle counter reaches 250, the 2 Cup button will continuously flash; indicating machine will need cleaning and descaling.

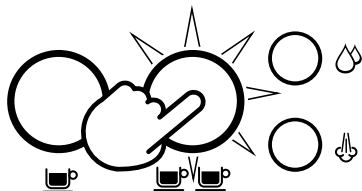

! WARNING

Do not immerse the power cord, power plug or appliance in water or any other liquid. The water tank should never be removed or completely emptied during descaling.

TO PERFORM A CLEAN & DESCALE CYCLE

1. Empty the drip tray and re-insert firmly into position on the machine.
2. Fill the water tank to the DESCALE line indicated and add the descaling agent to the water.

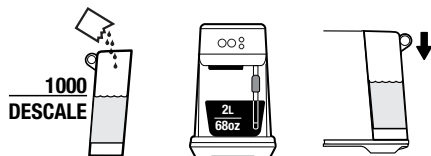

3. Place a 2L container under the group head and steam wand.

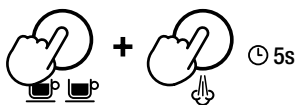

4. Press the 2 Cup and Steam buttons simultaneously for 5 seconds to start descaling.

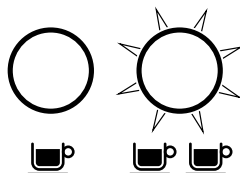

👁 NOTE

The 2-Cup button will flash throughout the cycle.

5. Once the descale solution has been used up, the descale mode will pause.
6. Rinse and refill the water tank to the MAX line and empty the waste water container, then replace both parts on to the machine to proceed onto the rinse cycle.
7. Press the 2 Cup button to proceed rinse cycle.
8. When the rinse cycle is complete, the machine will then go into ready mode.

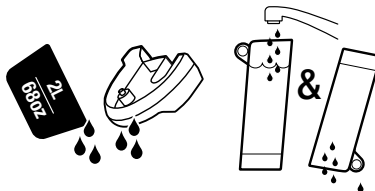

9. Remove and empty the waste water container. Rinse the drip tray and water tank and dry thoroughly before replacing them back onto the machine.



CLEANING THE STEAM WAND

- The steam wand should always be cleaned after texturing milk. Wipe the steam wand with a damp cloth.
- If any of the holes in the tip of the steam wand become blocked, it may reduce frothing performance. Manually purge the steam wand to try and clear the holes.
- If the steam flow is very small and steam wand is still blocked, unscrew the steam wand tip using the steam tip cleaning tool, then use the tool to unblock the holes; cleaning tool is located in the back of the machine, under the water tank.

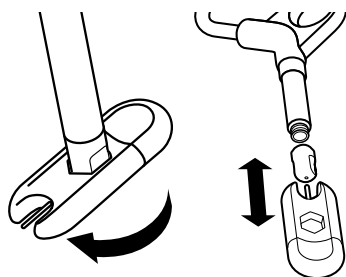

Rinse the steam tip and wipe with a clean, dry cloth. Reassemble the steam wand by screwing the steam tip back on to the steam wand. Purge the steam wand after cleaning.

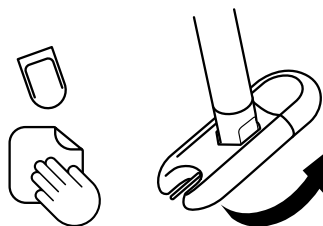

GROUP HEAD RINSE

- Press '2 Cup' button to flow freshwater flush cycle.

CLEANING THE FILTER BASKETS AND PORTAFILTER

- The filter baskets and portafilter should be rinsed under hot water directly after use to remove all residual coffee oils.
- If the holes in the filter baskets become blocked, use the steam wand cleaning tool to unblock the holes.



WARNING

Do not put portafilter in dishwasher.

CLEANING THE SHOWER SCREEN

- The group head interior and shower screen should be wiped with a damp cloth to remove any ground coffee particles.
- Periodically run hot water through the machine with the filter basket and portafilter in place, without any ground coffee, to rinse out any residual coffee.

CLEANING THE DRIP TRAY

The drip tray should be removed, emptied and cleaned after each use or when the drip tray indicator rises through the drip tray grid.

Remove the drip tray grid and wash both parts in warm soapy water.

CLEANING THE OUTER HOUSING

- Wipe the outer housing with a soft, damp cloth and then polish with a soft, dry cloth.



NOTE

Do not use any abrasive cleaners, pads or cloths which can scratch the surfaces of the machine.



NOTE

Do not clean any of the parts or accessories in the dishwasher.



WARNING

Do not immerse the power cord, power plug, plastic tamp or machine in water or any other liquid.

STORING YOUR MACHINE

Before storing, turn the machine off, switch off and remove the power plug from the power outlet. Empty the water tank and drip tray and ensure the machine is cool, clean and dry. Store in an upright position.

Do not place anything on top of the machine.

RESET FACTORY ESPRESSO VOLUME SETTINGS

1. When machine is on standby mode
2. Press and hold the 1 Cup and 2 Cup buttons for 10 seconds to enter Factory reset mode.
3. The lights will flash 3 times to indicate that all volumes have been reset.
4. Machine will then return to ready mode.



NOTE

When machine is turned on after reset, it enters directly to ready mode.



Troubleshooting

PROBLEM	POSSIBLE CAUSES	EASY SOLUTION
Water does not flow from the group head. No hot water.	<ul style="list-style-type: none">• Water tank is empty.• Water tank is not fully inserted and locked into position.• Machine needs to be cleaned & descaled.• Coffee is ground too finely and/or too much coffee in filter basket and/or over tamping and/or filter basket is blocked.	<ul style="list-style-type: none">• Fill tank.• Push water tank down completely to lock into place.• Perform clean & descale cycle.• See below, 'Espresso only drips from the portafilter spouts or not at all'.
Espresso only drips from the portafilter spouts or not at all.	<ul style="list-style-type: none">• Coffee is ground too finely.• Too much coffee in the filter basket.• Coffee tamped too firmly.• Water tank is empty. Fill tank.• Water tank is not fully inserted and locked into position.• The filter basket may be blocked.• Machine needs to be cleaned & descaled.	<ul style="list-style-type: none">• Use slightly coarser grind. Refer to 'Coffee Dose and Tamping' on page 12 and 'Extraction Tips' on page 15.• Lower dose of coffee.• Tamp between 15-20kgs (30-40 lbs) of pressure.• Fill tank.• Push water tank down completely to lock into place.• Use the pin on the end of the provided cleaning tool to unblock the hole(s).• Perform clean & descale cycle
Water doesn't come through (the machine makes a loud noise).	<ul style="list-style-type: none">• Water tank is empty	<ul style="list-style-type: none">• Fill tank
Espresso runs out too quickly	<ul style="list-style-type: none">• Coffee is ground too coarsely.• Not enough coffee in the filter basket.• Coffee tamped too lightly.	<ul style="list-style-type: none">• Use slightly finer grind.• Refer to 'Coffee Dose and Tamping' on page 12 and 'Extraction Tips' on page 15.• Increase dose of coffee and tamp. Refer to 'Coffee Dose and Tamping' on page 12 and 'Extraction Tips' on page 15.• Tamp between 15-20kgs (30-40 lbs) of pressure.
Espresso runs out around the edge of the portafilter.	<ul style="list-style-type: none">• Portafilter not inserted in the group head correctly.• There are coffee grounds around the filter basket rim.• Too much coffee in the filter basket.	<ul style="list-style-type: none">• Ensure portafilter is completely inserted and rotated until resistance is felt.• Clean excess coffee from the rim of the filter basket to ensure a proper seal in group head.• Lower dose of coffee. Refer to 'Coffee Dose and Tamping', page 12

PROBLEM	POSSIBLE CAUSES	EASY SOLUTION
Small steam.	<ul style="list-style-type: none"> • Machine has not reached operating temperature. • Water tank is empty. • Water tank is not fully inserted and locked into position. • Machine needs to be cleaned & descaled. • Steam wand is blocked or almost blocked. 	<ul style="list-style-type: none"> • Allow time for the machine to reach operating temperature. • Fill tank. • Push water tank down completely to lock into place. • Perform clean & descale cycle. • Refer to 'Cleaning the Steam Wand', page 17.
Pulsing/pumping sound while extracting espresso or steaming milk.	<ul style="list-style-type: none"> • The machine is carrying out the normal operation of the pump. • Water tank is empty. 	<ul style="list-style-type: none"> • No action required as this is the normal operation of the machine. • Fill tank.
Coffee not hot enough.	<ul style="list-style-type: none"> • Portafilter not pre-heated. 	<ul style="list-style-type: none"> • Rinse portafilter under hot water outlet. Dry thoroughly.
No crema.	<ul style="list-style-type: none"> • Coffee tamped too lightly. • Coffee is ground too coarsely. • Coffee beans or pre-ground coffee are not fresh. • The filter basket may be blocked. 	<ul style="list-style-type: none"> • Tamp between 15-20kgs (or 30-40 lbs) of pressure. • Use slightly finer grind. Refer to 'Coffee Dose and Tamping' on page 12 and 'Extraction Tips' on page 15. • If grinding fresh whole coffee beans, use freshly roasted coffee beans with a 'Roasted On' date and consume between 5-20 days after that date. If using pre-ground coffee, use within a week of grinding. • Use the pin on the end of the provided cleaning tool to unblock the hole(s).
Water leaking	<ul style="list-style-type: none"> • Manual purge • Water tank is not fully inserted and locked into position. 	<ul style="list-style-type: none"> • Turn the steam wand directly on the drip tray or jug before manual purge. • Push water tank down completely to lock into place.
Machine is on but ceases to operate.	<ul style="list-style-type: none"> • The safety thermal-cut out may have activated due to the pump overheating. 	<ul style="list-style-type: none"> • Press the 1 CUP and HOT WATER buttons simultaneously for 0.5 seconds to switch the machine off and unplug from the power outlet. Allow to cool for about 30-60 minutes. If problem persists, call Breville Support.
2-cup coffee button flashing	<ul style="list-style-type: none"> • This indicates machine needs cleaning and descaling 	<ul style="list-style-type: none"> • Perform a clean and descale cycle. Follow the steps outlined on page 16.
Too much/too little espresso is being delivered to the cup.	<ul style="list-style-type: none"> • Grind amount and/or grind size settings and/or shot volumes require adjustment. 	<ul style="list-style-type: none"> • Adjust the grind amount and/or grind size settings. Refer to 'Coffee Dose and Tamping', page 12, 'The Grind', page 12 and 'Extraction Tips', page 15.



Notes



Notes



Notes

Breville Customer Service Centre

Australian Customers

Phone: 1300 139 798

Web: www.breville.com

New Zealand Customers

Phone: 0800 273 845

Web: www.breville.com

Breville®

Master Every Moment™

Breville, the Breville logo, Bambino, ThermoJet, Breville Assist and Master Every Moment are trademarks of Breville Pty Ltd ("Breville").
A.B.N. 98 000 092 928. Copyright Breville Pty. Ltd. 2020.

Due to continued product improvement, the products illustrated/photographed in this booklet
may vary slightly from the actual product.

BES450 ANZ A20